

memmert

Operating manual



UFTS

Pass-through oven UFTS

Table of Contents

1. About this Manual	5
2. Safety	7
2.1 Terms and Symbols Used	7
2.1.1 Terms Used.....	7
2.1.2 Symbols Used	7
2.2 Product Safety and Dangers.....	8
2.3 Requirements to be met by Operating Personnel.....	9
2.4 Responsibility of the Owner	9
2.5 Product Use	9
2.5.1 Intended Use.....	9
2.5.2 Improper Use	9
2.6 Changes and Alterations.....	10
2.7 Behaviour in case of Malfunctions and Irregularities	10
2.8 Switching off the Unit in an Emergency.....	10
3. Construction and Description	11
3.1 Design.....	11
3.2 Description of Function	11
3.3 Materials	12
3.4 Electrical Equipment.....	12
3.5 Connections and Interfaces	12
3.5.1 Electrical Connection.....	12
3.5.2 Communication Interfaces.....	12
3.6 Nameplate.....	13
3.7 Technical Data	14
3.8 Applied Directives and Standards.....	15
3.8.1 Declaration of Conformity.....	15
3.8.2 Material Compliance.....	16
3.9 Ambient Conditions.....	16
3.10 Scope of Delivery	17
4. Delivery, Transport and Setting Up	18
4.1 Safety.....	18
4.2 Delivery	18
4.3 Transport.....	18
4.4 Unpacking.....	18
4.5 Storage after Delivery	19
4.6 Setting Up.....	19
4.6.1 Preconditions.....	19
4.6.2 Fastening the Appliance	20
4.6.3 Adjusting the Doors.....	21

5. Putting into Operation	22
5.1 Putting into Operation for the First Time.....	22
5.2 Connecting the Unit to the Power Supply	22
5.3 Switching on Unit	23
6. Operation and Control	24
6.1 Operating Personnel.....	24
6.2 Opening the Door	24
6.3 Loading the Appliance	26
6.4 Operating the Appliance	27
6.4.1 ControlCOCKPIT.....	27
6.4.2 Basic Operation.....	27
6.5 Operating Modes.....	28
6.5.1 Manual Mode	29
6.5.2 Digital Backwards Counter.....	30
6.5.3 Programme Mode.....	31
6.6 Monitoring Function	33
6.6.1 Temperature Monitoring	33
6.6.2 Electronic Temperature Monitoring (TWW)	34
6.6.3 Temperature Selector Limiter (TWB).....	35
6.6.4 Automatic Temperature Monitor (ASF)	35
6.6.5 Mechanical Temperature Monitoring: Temperature Limiter (TB).....	35
6.6.6 Adjusting the Temperature Monitoring	36
6.7 Graph	37
6.7.1 Temperature Curve.....	37
6.8 Ending Operation.....	38
7. Malfunctions, Warning and Error Messages	39
7.1 Warning Message of the Monitoring Function	39
7.1.1 Temperature Monitoring	39
7.2 Malfunctions, Operating Problems and Unit Errors	40
7.2.1 Power Failure	41
8. Menu Mode	42
8.1 Overview.....	42
8.2 Basic Operation in Menu Mode Using the Example of Language Selection.....	42
8.3 Setup.....	43
8.3.1 Overview.....	43
8.3.2 IP Address and Subnet Mask	44
8.3.3 Unit	45
8.3.4 Temperature Monitoring	45
8.3.5 Timer Mode	45
8.3.6 Shelf Type (Grid or metal plate).....	46
8.3.7 Balance	46

8.3.8 Remote Control	47
8.3.9 Gateway.....	47
8.4 Date and Time.....	47
8.5 Calibrate.....	48
8.5.1 Temperature Calibration	48
8.6 Programme.....	50
8.7 Acoustic Signals	51
8.8 Log.....	52
8.9 USER ID	53
8.9.1 Description	53
8.9.2 USER ID Activation and Deactivation	53
9. Maintenance and Servicing	55
9.1 Cleaning	55
9.2 Regular Maintenance.....	55
9.3 Repairs and Service.....	56
10. Storage, Transport and Disposal	57
10.1 Storage and Transport.....	57
10.2 Disposal	57

1. About this Manual

Purpose and target audience

This manual describes the design, function, transport, operation and maintenance of the product series Pass-through ovens UF TS. It is intended for use by trained personnel employed by the owner who are tasked with operating and/or maintaining the unit.

If you have been tasked with working on the unit, read this manual carefully before starting work. Familiarise yourself with the safety instructions. Only perform work that is described in this manual. If there is anything you do not understand, or if any information is lacking, ask your line manager or contact the manufacturer. Do not take any course of action on your own initiative.

Versions

The appliances are available in different equipment versions and sizes. If certain features or functions are only available in certain equipment versions, this is indicated at the relevant points in this manual.

The functions described in this manual relate to the most recent firmware version.

Due to the different equipment versions and sizes, the illustrations in this manual may be slightly different to your product. However, the product is identical in terms of its operation and function.

Further applicable documents

In addition to this manual, please observe the following documents:

- Service manual:
To carry out service and repair work you will require the separate service manual. Manuals can be requested from Memmert International After Sales or downloaded from www.memmert.com.
- AtmoCONTROL software manual
When operating the unit with the MEMMERT AtmoCONTROL PC software you will require the separate manual. You can find the manual for the AtmoCONTROL software in the AtmoCONTROL menu bar under 'Help'

Retaining and passing on this manual

This operating manual belongs to the unit and must always be kept in a location where it can be easily found by those working with the unit. It is the responsibility of the owner to ensure that persons who work on the unit know where this operating manual is. We recommend always storing it in a safe place near the unit.

Ensure that the manual is not damaged by heat or humidity. If the unit is sold or transported and re-installed at another location, this operating manual must be handed over with the unit. The current version of this operating manual is also available in PDF format at www.memmert.com.

Address and Customer Service

Manufacturer's address

Memmert GmbH + Co. KG
Äußere Rittersbacher Straße 38 D-91126 Schwabach Germany
Tel. +49 9122 925-0
E-mail: sales@memmert.com
www.memmert.com

International After Sales

Memmert GmbH + Co. KG
Willi-Memmert-Straße 90-96 D-91186 Büchenbach Germany
Tel. +49 9171 9792 911
E-mail: service@memmert.com
www.memmert.com
If you have any queries, please always quote the product number on the nameplate.

Shipping address for repairs

Memmert GmbH + Co. KG
Willi-Memmert-Straße 90-96 D-91186 Büchenbach Germany
Please contact our customer service before sending appliances for repair or before making returns, otherwise, we have to refuse acceptance of the shipment.

2. Safety

2.1 Terms and Symbols Used

In this manual and on the unit itself, certain recurring terms and symbols are used to warn you of hazards or give you information that is important in order to prevent injury or damage. To avoid accidents and damage, observe and follow these instructions. These terms and symbols are explained below.

2.1.1 Terms Used

	Warns of a dangerous situation that will result directly in death or serious (irreversible) injury.
	Warns of a dangerous situation that could result in death or serious physical injury.
	Warns of a dangerous situation that could result in moderate or minor physical injury.
	Warns of damage to property.

2.1.2 Symbols Used

	Risk of explosion		Gases / vapours
	Do not lift unit		Do not tilt
	Do not enter		Danger of electrocution
	Flammable substances		Hot surfaces
	General warning sign		Tipping hazard
	Disconnect the mains plug		Wear gloves
	Wear safety shoes		Observe information in separate manual

2.2 Product Safety and Dangers

The units described in this manual are technically sophisticated, manufactured using high-quality materials and subject to many hours of testing in the factory. They reflect the state of the art and comply with recognised technical safety regulations. However, there are still risks involved, even when the units are used as intended. These are described below.

DANGER



Risk of electric shock due to ingress of liquids

Penetration of liquid into the appliance can cause electric shocks and short circuits.

- Protect the appliance from splashing water.
- Switch off the appliance and disconnect the mains plug before carrying out any cleaning and maintenance work.
- The appliance must not be wet cleaned and disinfected. Allow the appliance to dry completely before putting it back into operation.
- When loading the chamber with wet material, insert the drip tray provided for the appliance size.

DANGER



Live parts

When covers are removed, live parts are exposed and contact with these parts may result in electric shock. Electric shock can have serious health consequences including death.

- Only authorised persons may carry out electrical installation work.
- Before starting work, disconnect the unit from the power supply.
- Ensure that the unit is fully de-energised.
- Secure the unit to prevent it from being switched on again.

DANGER



Danger of suffocation inside the appliance

If the appliances is a certain size, you can get accidentally locked in, which is potentially life-threatening.

- Do not climb into the appliance.
- Do not carry out cleaning work in the chamber alone.

WARNING



Poisonous or explosive vapours and gases

When loading the unit with an unsuitable load, poisonous or explosive vapours or gases may be produced. This could cause the unit to explode, and persons could be severely injured or poisoned.

- The unit may only be loaded with materials and substances which cannot form any toxic or explosive vapours at the set temperature and which cannot explode, burst or ignite.

WARNING



Overheating of the appliance when door is open

Leaving the door open during operation can cause the appliance to overheat or pose a fire hazard.

- Do not leave the door open during operation.

⚠ WARNING**Hot surfaces**

Depending on the operating situation, the unit and the load may be hot. Contact with hot surfaces may have serious health consequences due to burns!

- Allow the unit to cool down.
- Wear heat-resistant protective gloves when carrying out work.
- Check the temperature of surfaces before touching them.

2.3 Requirements to be met by Operating Personnel

The appliance may only be operated and maintained by persons who are of legal age and have been instructed accordingly. It is intended to be operated and maintained by trained personnel employed by the owner.

Repairs may only be performed by qualified electricians. The guidelines in the separate service manual must be observed.

2.4 Responsibility of the Owner

The owner of the unit

- is responsible for the flawless condition of the unit and for operating it in accordance with its intended use;
- is responsible for ensuring that persons who operate or service the unit are qualified to do this, have been instructed accordingly and are familiar with these operating instructions;
- must know the applicable guidelines, requirements and operational safety regulations, and train staff accordingly;
- is responsible for ensuring that unauthorised persons cannot access the unit;
- is responsible for ensuring that the maintenance plan is adhered to and that maintenance work is properly carried out;
- has to ensure that the unit and its surroundings are kept clean and tidy, for example through corresponding instructions and inspections;
- is responsible for ensuring that personal protective clothing is worn by operating personnel, e.g. work clothes, safety shoes and protective gloves.

2.5 Product Use

2.5.1 Intended Use

This appliance is exclusively intended for heating up non-explosive and non-combustible substances and objects.

2.5.2 Improper Use

Any other use is improper and may result in danger and damage.

The appliance is not explosion-proof (does not comply with the German occupational health and safety regulation VBG 24). Only materials and substances which cannot form any toxic or explosive vapours at the set temperature and which cannot explode, burst or ignite may be put in the appliance.

The appliance must not be used to dry, vaporise or brand materials whose procurement or constituents pose a risk of fire and/or explosion, especially if the solvents of these materials could form an explosive mixture when combined with air. If you are not sure whether a given material has these characteristics, you must not put it in the appliance. Potentially explosive gas-air mixtures must not be able to form in the working chamber or in the direct vicinity of the appliance.

2.6 Changes and Alterations

Unauthorised changes or alterations must not be made to the appliance. Parts that are not approved by the manufacturer must not be mounted or built in.

Unauthorised changes or alterations result in the CE declaration of conformity losing its validity, and the appliance must no longer be operated.

The manufacturer is not liable for any damage, danger or injuries that emanating from unauthorised changes or alterations, or from non-compliance with the provisions in this manual.

2.7 Behaviour in case of Malfunctions and Irregularities



The unit must only be used in a flawless condition. If you, as the operator, notice irregularities, malfunctions or damage, immediately turn off the unit and inform your line manager.



You can find information on troubleshooting in the chapter ▶7 Malfunctions, Warning and Error Messages.

See also

- ▶ Malfunctions, Warning and Error Messages [▶ 39]

2.8 Switching off the Unit in an Emergency

WARNING



Hot surfaces

Depending on the operating situation, the unit and the load may be hot. Contact with hot surfaces may have serious health consequences due to burns!

- Allow the unit to cool down.
- Wear heat-resistant protective gloves when carrying out work.
- Check the temperature of surfaces before touching them.

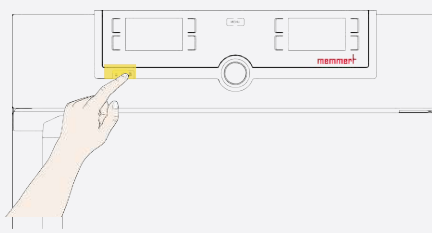

1. Press the main switch on the appliance.
 2. Unplug the mains plug from the power source.
- ⇒ This disconnects the appliance from the power supply at all poles.

3. Construction and Description

3.1 Design



1 Ethernet connection	2 Main switch
3 Grid	4 Mains connection
5 ControlCOCKPIT with capacitive function keys and LCD displays	6 USB port
7 Turn control with confirmation key	8 Door handle
9 Nameplate	

3.2 Description of Function

UFTS-type appliances feature forced ventilation (convection). The pipe is encased by an air jacket which preheats the fresh air. Incoming fresh air is supplied to the air jacket and pushed into the air jacket by a fan. Fresh air flows into the chamber via ventilation slots in the pipe. The exhaust air outlet is on the top of the appliance ⑨.

The appliance may be equipped with a mutual door locking system that prevents the door(s) from being opened on the cleanroom side and the greyroom side simultaneously (see ▶6.2 Opening the Door).

See also

 Opening the Door [▶ 24](#)

3.3 Materials



For the outer housing, MEMMERT processes stainless steel (Mat. No. 1.4016 – ASTM 430) for the chamber, stainless steel (Mat. No. 1.4301 – ASTM 304) is used, which stands out through its high stability, optimal hygienic properties and corrosion-resistance to many (but not all) chemical compounds (caution must be exercised with chlorine compounds, for example).

The chamber load of the appliance must be carefully checked for chemical compatibility with the above materials. A material resistance table can be requested from the manufacturer.

3.4 Electrical Equipment

- Operating voltage and current consumption: See [▶3.6 Nameplate](#) or [▶3.7 Technical Data](#)
- Degree of protection IP 20 acc. to DIN EN 60529
- Protection class I, i.e. operating insulation with PE conductor connection according to EN 61010
- Interference suppression acc. to EN 55011 class B
- Appliance fuse: Fusible link 250 V/15 A quick-blow
- The temperature controller is protected by a miniature fuse 100 mA (160 mA at 115 V)

See also

-  [Technical Data \[▶ 14\]\(#\)](#)
-  [Nameplate \[▶ 13\]\(#\)](#)

3.5 Connections and Interfaces

3.5.1 Electrical Connection

This unit is designed for operation on an electrical power system with a maximum system impedance Z_{max} at the point of transfer (service line) of 0.292 Ohm. The operator must ensure that the unit is only operated on an electrical power system that meets these requirements.

If necessary, ask your local utility company what the system impedance is. Observe the country-specific regulations when making connections (e.g. in Germany DIN VDE 0100 with earth leakage circuit breaker).

3.5.2 Communication Interfaces

The communication interfaces are intended for appliances which meet the requirements of IEC 60950-1.

Ethernet interface



You will find a description of how to transfer programs via Ethernet in the AtmoCONTROL software manual.



The unit can be connected to a network via the Ethernet interface, so that you can transfer programmes created with the AtmoCONTROL software to the unit and export logs.

For identification purposes, each unit connected must have its own unique IP address. A description of how to set the IP address is provided in chapter ▶8.3.2 IP Address and Subnet Mask.

The unit can be directly connected to a computer / laptop using an optional USB to Ethernet converter (see ▶3.10 Scope of Delivery).

USB interface

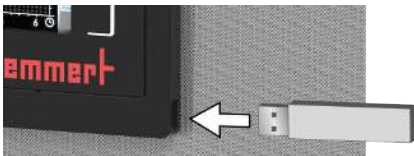

The unit comes with a USB port as standard in accordance with the USB specification. With this you can:

- transfer software stored on a USB storage medium to the unit (see ▶8.6 Programme)
- export logs from the unit to a USB storage medium (see ▶8.8 Log)
- transfer user ID data stored on a USB storage medium to the unit (see ▶8.9 USER ID)

The USB port is located on the right of the ControlCOCKPIT.

See also

- IP Address and Subnet Mask [▶ 44]
- Scope of Delivery [▶ 17]
- Programme [▶ 50]
- Log [▶ 52]
- USER ID [▶ 53]

3.6 Nameplate

The nameplate provides information about the appliance model, manufacturer and technical data. It is attached to the front of the appliance, on the right behind the door (see ▶3.1 Design).

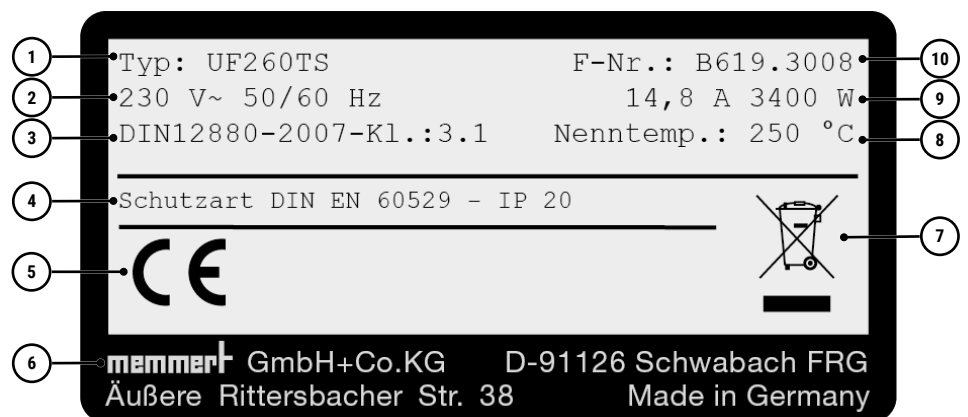

1	Type designation	2	Operating voltage
3	Applicable standard	4	Degree of protection
5	CE conformity	6	Manufacturer's address
7	Information regarding disposal	8	Temperature range
9	Connected loads / power ratings	10	Appliance number

See also

- Design [▶ 11]

3.7 Technical Data

Appliance size			160	260	450	750	
Stainless steel interior	Volume		l	161	256	449	749
	Width	A	mm	560	640	1,040	1,040
	Height	B	mm	720	800	720	1,200
	Depth	C	mm	400	500	600	600
	Max. number of shelves		Pc	8	9	8	14
	Max. loading per shelf		kg	20	20	30	30
	Max. loading per appliance		kg	210	300	300	300
	Max. loading per insertable/removable drip tray		kg	3	4	8	8
	Max. loading per bottom drip tray		kg	3	4	8	8
Patterned stainless steel housing	Width	D	mm	745	825	1,224	1,224
	Height	E	mm	1,233	1,314	1,233	1,714
	Depth	F	mm	582	682	782	782
Temperature	Operating temperature range		°C	at least 10 above room temperature up to +250			
	Setting temperature range		°C	+20 up to +250			
	Adjustment precision		°C	up to 99.9: 0.1 / from 100: 0.5			
Further data	Power consumption (50/60 Hz)	230 V	W	3,200	3,400	-	
		115 V	W	1,800	1,800	-	
		400 V	W	-		4,800	5,000
		3 x 230 V w/o neutral	W	-		4,800	5,000
	Max. current consumption (50/60 Hz)	230 V	A	13.9	14.8	-	
		115 V	A	15.6	15.6	-	
		400 V	A	-		8.4	12.1
		3 x 230 V w/o neutral	A	-		25.3	21.8
Packaging data	Net weight		kg	120	138	213	260
	Gross weight		kg	146	189	279	331
	Width		mm	830	930	1,330	1,330
	Height		mm	1,300	1,380	1,450	1,920
	Depth		mm	800	930	1,050	1,050

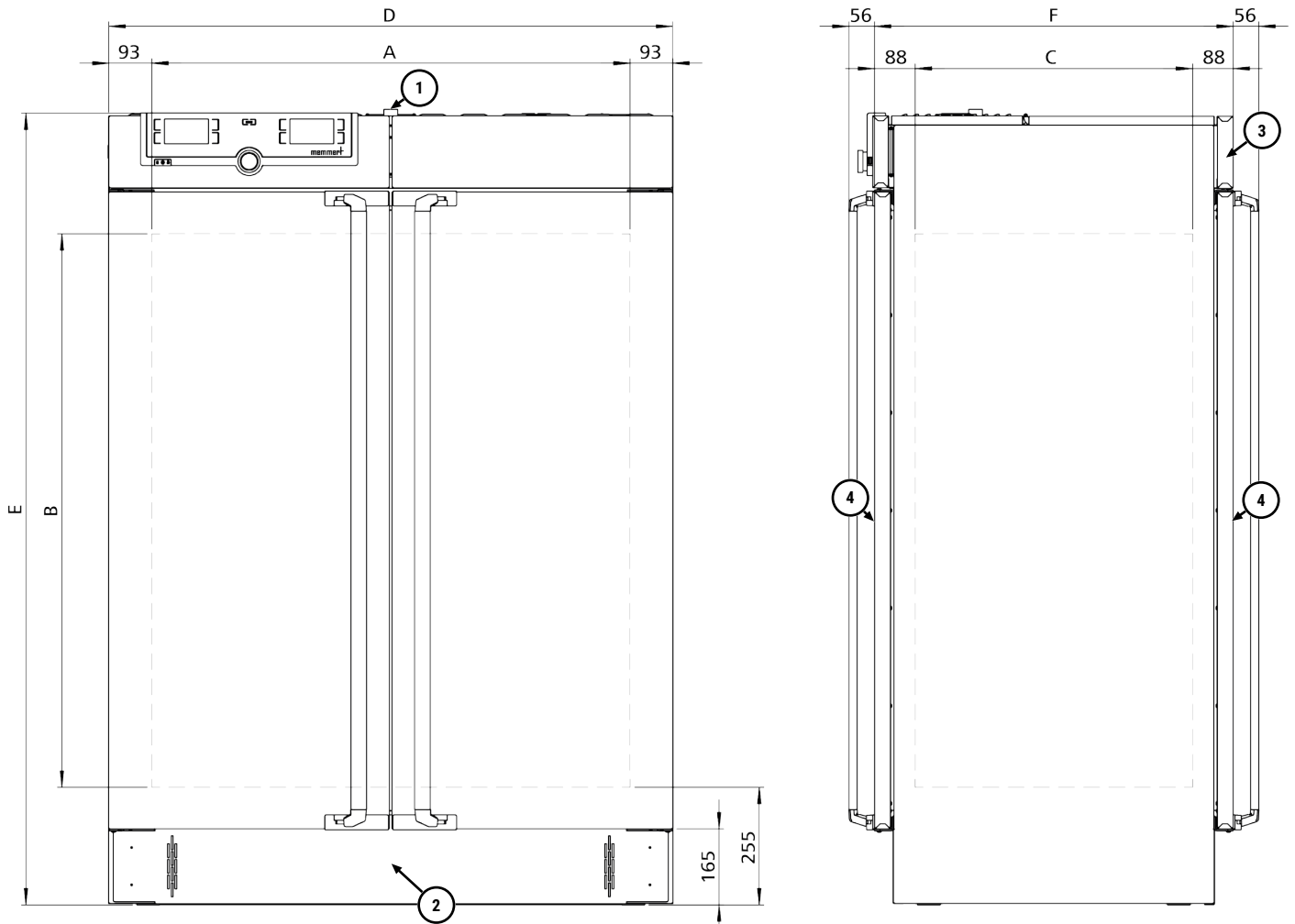

1 Exhaust air d = 30 mm	2 Grey room side skirting (can be removed to adjust the levelling feet)
3 Supply air	4 Door
4 Door	

3.8 Applied Directives and Standards

3.8.1 Declaration of Conformity



You can download the EC declaration of conformity of the appliance online:

English: <http://www.memmert.com>

German: <http://www.memmert.com>

Based on the standards and guidelines listed below, the products described in this manual carry a CE mark from Memmert:

Low Voltage Directive 2014/35/EU

- EN 61010-1:2010, EN 61010-1:2010/A1:2019/AC:2019-04, EN 61010-1:2010/A1:2019; EN IEC 61010-2-010:2020

EMC-Directive 2014/30/EU

Directive 2014/30/EU with amendments (Council Directive on the approximation of the laws of the Member States relating to electromagnetic compatibility). Standards complied with:

- EN 61326-1:2013

Directive 2011/65/EU

Directive 2011/65/EU of the European Parliament and of the Council on the restriction of the use of certain hazardous substances in electrical and electronic equipment.

3.8.2 Material Compliance

We confirm that we always draw the attention of our suppliers to the legal restrictions on materials in accordance with our **Company Standard for Material Compliance of Memmert GmbH + Co KG** to ensure they take the original publications by the legislative authority into consideration at all times. The suppliers and deliveries must comply with all material compliance requirements which are relevant or specified in the company standard. By taking this approach, and by making our own observations, we are always able to stay abreast of developments to the best of our knowledge and ability.

In accordance with the REACH regulation and the RoHS guideline, Memmert provides information on the chemical substances in Memmert appliances online at:

www.memmert.com

3.8.2.1 REACH information of Memmert GmbH + Co. KG acc. to Regulation (EG) No. 1907/2006, Art. 33

Based on current knowledge, we confirm that products or sub-products containing substances of very high concern (SVHC in the specified components) in the Candidate List with concentrations higher than 0.1 mass % are installed in the appliances we supply:

Appliance component	Substance in the Candidate List SVHC	CAS No.
Blue housing protection film	Tris(4-nonylphenyl, branched and linear) phosphite	■ 26523-78-4
		■ 3050-88-2
		■ 31631-13-7
		■ 106599-06-8
Seal inserts made of NBR	2,2'-Methylenbis(4-methyl 6-tert-butylphenol)	■ 119-47-1

3.8.2.2 RoHS Information of Memmert GmbH + Co. KG acc. to Directive 2011/65/EU and Delegated Directive 2015/863

We confirm that we comply with the substance restrictions in accordance with 2011/65/EU for the supplied products, accessories and spare parts. With regard to the substance lead, we and/or our suppliers make use of the applications exempted from the restriction for lead stated in appendix III in a credible, trustworthy manner.

3.9 Ambient Conditions

- The unit must only be used in closed rooms and in the ambient conditions listed below:

Ambient temperature	+5 °C to +40 °C
Air humidity	max. 80% non-condensing
Overvoltage category	II
Contamination level	2
Installation altitude a.s.l.	max. 2000 m a.s.l.

- The unit may not be used in Ex zones. The ambient air must not contain explosive dusts, gases, vapours or gas-air mixtures. The unit is not explosion-proof.
- Heavy dust production or aggressive vapours in the vicinity of the unit could lead to sedimentation in the interior and, as a consequence, could result in short circuits or damage to electrical parts. For this reason, sufficient measures to prevent large accumulations of dust or aggressive vapours should be taken.

3.10 Scope of Delivery

Standard delivery

- Mains connection cable
- Two insertable/removable grids
- Anti-tilt bracket
- Base cladding with screw connection
- USB storage medium with software and AtmoCONTROL manual
- Operating manual
- Calibration certificate

Optional accessories

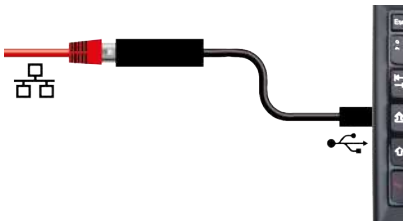

- Ethernet to USB converter. Makes it possible to connect the Ethernet port of the appliance to the USB port of a computer/laptop.
- Reinforced, insertable/removable grids with a load capacity of 60 kg each.
- Wall frame with manual and screw connection

4. Delivery, Transport and Setting Up

4.1 Safety

⚠ CAUTION



Lifting the appliance incorrectly

The appliance is heavy. Because of the heavy weight of the appliance, you could injure yourself if you try to lift it.

- The appliance must only be transported using a pallet truck or forklift truck.



⚠ CAUTION



Risk of injury due to the appliance falling over during transport

The appliance is heavy. The appliance could fall over and seriously injure you.

- Never tilt the appliance and only transport it in the upright position without load (except for standard accessories such as grids or shelves).
- Appliances with castors always have to be moved by at least two people.

4.2 Delivery

The appliance is supplied packed in cardboard on a wooden pallette.

4.3 Transport

The unit can be transported in different ways depending on its size:

- With a forklift truck or pallet truck; move the forks of the truck entirely under the pallet

4.4 Unpacking

- Do not unpack the appliance until you reach the installation site.
- Remove the cardboard packaging by pulling it upwards or carefully cutting along an edge or unscrew and remove wooden crate.

Checking for completeness and transport damage

- Check the delivery note to ensure the delivery is complete.
- Check the unit for damage.

If you notice deviations from the scope of delivery, damage or anything unusual, do not put the unit into operation and inform the haulage company and the manufacturer.

Removing the transportation lock

- Remove the transportation lock. It is located between the door hinge, door and frame and has to be removed after opening the door.

4.5 Storage after Delivery

If the unit is initially to be stored after delivery:

- Observe storage conditions (see ▶10.1 Storage and Transport)

See also

Storage and Transport [▶ 57]

4.6 Setting Up

WARNING



Danger of tipping due to the appliance's centre of gravity

Due to its centre of gravity, the appliance could tip forwards and injure you or someone else.

- Always screw the appliance firmly down at the mounting elements provided on the base of the housing.
- In case there is not enough space to fasten the appliance to a wall, do not put the appliance into operation and do not open the door.
- Contact Memmert service.

4.6.1 Preconditions



- ✓ The installation site must be flat and horizontal and must be able to reliably bear the weight of the unit (see ▶3.7 Technical Data). Place the unit on a heat-resistant, fireproof and non-flammable surface.
- ✓ Depending on the model (see ▶3.6 Nameplate), a 230 V, 115 V or 400 V power connection must be available at the installation site.
- ✓ Pass-through ovens are intended for wall mounting. An opening in the wall is required for this. Optionally, frames can be ordered for protection against contamination of the cleanroom, which additionally seal the wall breakthrough (see supplementary manual for frame installation). The size of the wall opening can be found in the following table:

Appliance	Size of wall opening (W x H in mm; tolerance + 25 mm respectively)
UF160TS	825 x 1255
UF260TS	905 x 1335
UF450TS	1305 x 1255
UF750TS	1305 x 1735



Make sure that exhaust air is located on the greyroom side and the supply air opening is on the cleanroom side. The ControlCOCKPIT must always be located on the greyroom side.

See also

-  [Technical Data \[▶ 14\]](#)
-  [Nameplate \[▶ 13\]](#)

4.6.2 Fastening the Appliance



The appliance must be firmly connected to the housing base.



1. Screw the appliance to the housing base at the four feet using two screws per foot.



2. Screw the front and back cover on.

4.6.3 Adjusting the Doors

You can adjust the doors if necessary, for example if they are warped due to uneven flooring. There are two adjusting screws on each door for this purpose; one at the top and one at the bottom.

First, adjust the setting at the top of the door and, if this is not sufficient, adjust the bottom.



A service video which explains how to adjust the door is available:
www.memmert.com/de/downloads/media/service-videos/

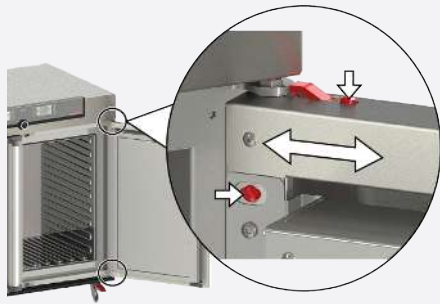

1. Open the door.
2. Loosen the screws.
3. Adjust the position of the door.
4. Tighten the screws again.
5. Check the position of the door.
6. Readjust if required.

5. Putting into Operation

5.1 Putting into Operation for the First Time

⚠ WARNING



Condensation in the electrical components may cause short circuits.

Due to temperature fluctuations during transport, condensation may form inside the unit.

- After transporting or storing the unit in humid conditions, remove it from its packaging and allow it to acclimatise for at least 24 hours in normal ambient conditions.
- Do not connect the unit to the power supply during this time.

NOTICE



When putting the unit into operation for the first time, do not leave it unattended until it has reached a steady state.

- Please observe the national regulations when connecting the unit.
- Observe the connected loads and power ratings (see ▶3.6 Nameplate and ▶3.7 Technical Data).
- Be sure to establish a safe PE conductor connection.

See also

- 📄 Nameplate [▶ 13]
- 📄 Technical Data [▶ 14]

5.2 Connecting the Unit to the Power Supply



Observe the country-specific regulations when making connections (e.g. DIN VDE 0100 with earth leakage circuit breaker, in Germany).

Observe the connected loads and power ratings (see ▶3.6 Nameplate and ▶3.7 Technical Data).

Be sure to establish a safe PE conductor connection.

115 / 230 V appliances:

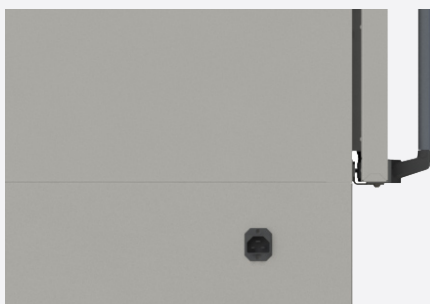

Route the power cable so that

- nobody can trip over it.
- it cannot come into contact with any hot parts.
- it is easily accessible at all times and the plug can be pulled out quickly in the event of a fault or emergency, for example.

400 V appliances:



The power cable is permanently installed.

- Connect the plug to a 400 V CEE coupling.

See also

- 📄 Nameplate [▶ 13]
- 📄 Technical Data [▶ 14]

5.3 Switching on Unit

NOTICE



If equipped with a mutual door locking system, the doors on both the cleanroom side and the greyroom side have to be closed when switching on. In the initial phase, a servo motor extends a locking bolt and locks the doors. If one of the doors is open, the locking bolt does not lock the door properly. This is prevented by the door-open detection.

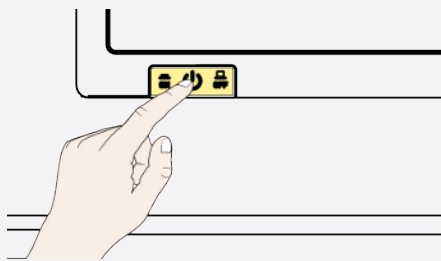

1. Switch on the appliance by pressing the main switch on the front of the appliance.
⇒ The starting process is shown by three animated white dots **•••** (see ▶7.1 Warning Message of the Monitoring Function).



After the first start-up, the appliance display is set to English by default. You can change the language as described in chapter ▶8.2 Basic Operation in Menu Mode Using the Example of Language Selection. However, to get a basic overview of operating the appliance, you should read the following chapter first.

See also

- 📄 Basic Operation in Menu Mode Using the Example of Language Selection [▶ 42]
- 📄 Warning Message of the Monitoring Function [▶ 39]

6. Operation and Control

6.1 Operating Personnel

The appliance may only be operated by persons who are of legal age and have been instructed accordingly. Personnel who are to be trained, instructed or who are undergoing general training may only work with the appliance under constant supervision of an experienced person.

6.2 Opening the Door

⚠ DANGER



Danger of suffocation inside the appliance

If the appliances is a certain size, you can get accidentally locked in, which is potentially life-threatening.

- Do not climb into the appliance.
- Do not carry out cleaning work in the chamber alone.

⚠ WARNING



Overheating of the appliance when door is open

Leaving the door open during operation can cause the appliance to overheat or pose a fire hazard.

- Do not leave the door open during operation.

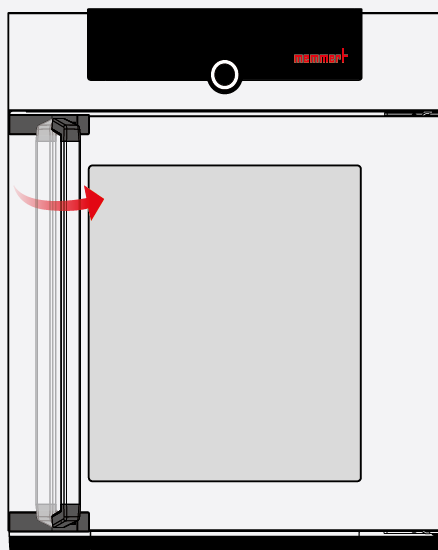

1. To open the door, pull the door handle to the side.

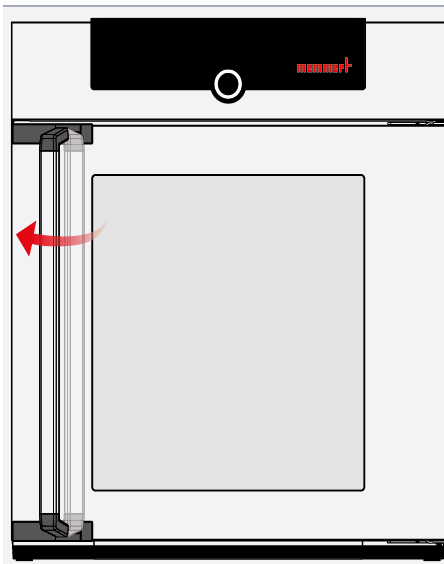

2. To close the door, push the door closed and push the door handle to the side.

Process-dependent mutual door locking system (optional)

A mutual door locking system (optional) prevents both doors from being opened simultaneously, so that no contamination can occur in the cleanroom. In the basic state (no active programme), the door is unlocked on the greyroom side (ControlCOCKPIT side) and locked on the cleanroom side.

Door locking logic in programme mode

Situation	Cleanroom	Greyroom
Basic state (no active programme)		
Appliance loaded and programme started		
Programme ended properly		
Cleanroom door opened, chamber load taken out and door closed again		
Keep transfer key pressed until cleanroom side is locked and greyroom side is unlocked.		

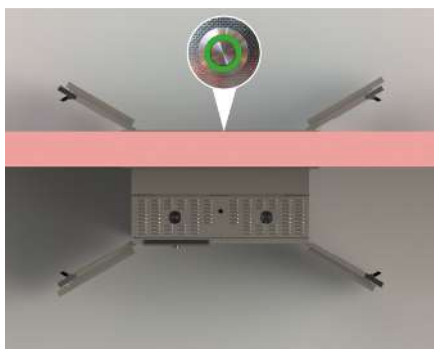

If equipped with a mutual door locking system, the appliance will have a transfer key on the cleanroom side.

When programme mode is active, the transfer key lights up green. Once a programme has finished, the light flashes and the door on the cleanroom side is unlocked.

Transfer key	Appliance status
Lamp does not light up	Appliance in basic state, no programme active
Lamp remains on	Appliance in programme mode, programme running
Lamp flashes approximately once every 4 seconds	Appliance in programme mode. Programme finished correctly

6.3 Loading the Appliance

⚠ WARNING



Poisonous or explosive vapours and gases

When loading the unit with an unsuitable load, poisonous or explosive vapours or gases may be produced. This could cause the unit to explode, and persons could be severely injured or poisoned.

- The unit may only be loaded with materials and substances which cannot form any toxic or explosive vapours at the set temperature and which cannot explode, burst or ignite.

NOTICE



Chemical compatibility of the chamber load

Chemical incompatibility may result in damage to the appliance.

- Check the chamber load for chemical compatibility with the materials of the appliance (see ▶3.3 Materials).



Insert the metal grids or shelves. The maximum number of grids / shelves and the load capacity are specified in the ▶3.7 Technical Data.

- To achieve the most efficient temperature distribution, the type of insert used – grid or shelf – has to be set in the menu under **SETUP**.

The appliance must not be loaded too densely to ensure that air can circulate freely inside the chamber. If the chamber loading is unfavourable (chamber too densely packed), the set temperature may be exceeded or it may take longer until it is reached.

- Do not place any of the chamber load on the bottom, touching the side walls or right below the ceiling of the chamber.
- See also the “correct loading” sticker on the appliance.

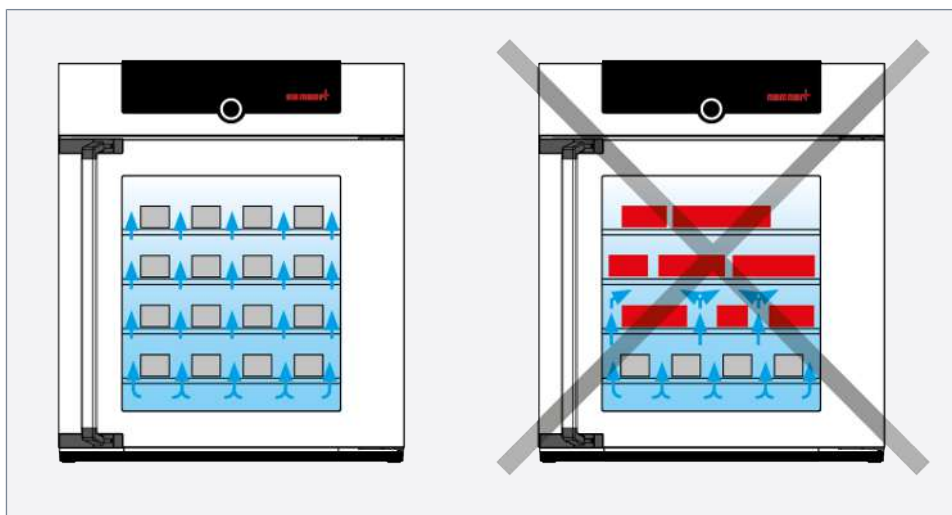

See also

- 📄 Materials [▶ 12]
- 📄 Technical Data [▶ 14]

6.4 Operating the Appliance

6.4.1 ControlCOCKPIT

In manual operation, the desired parameters are entered at the ControlCOCKPIT on the front of the appliance. You can also make basic settings here (**menu mode**). Warning messages are also displayed, e.g. if the temperature is exceeded. In programme mode, the parameters defined, the programme description, the programme segment currently active and remaining programme runtime are displayed.

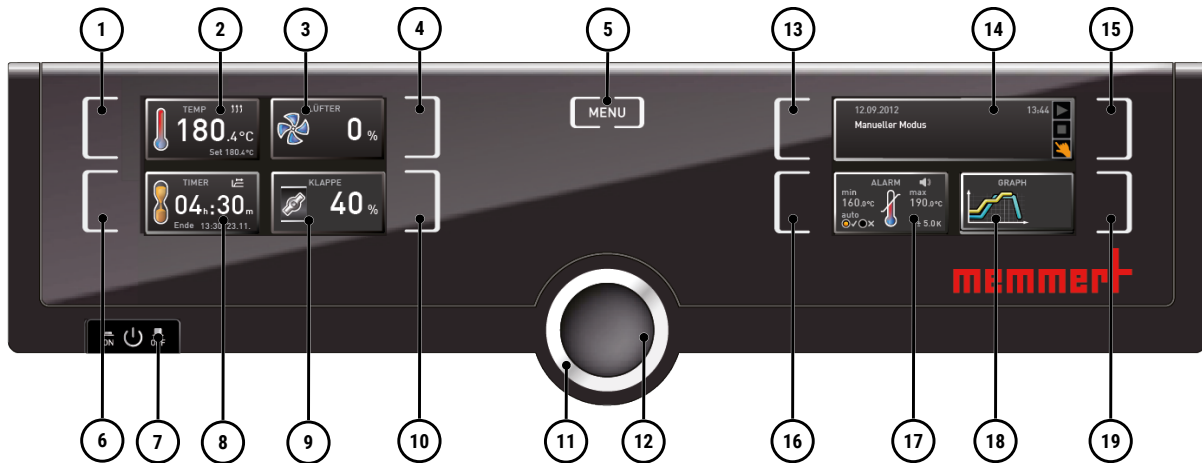

1	Activation key for temperature setpoint input	2	Setpoint and actual temperature display
3	Fan speed display	4	Activation key for fan speed setting
5	Switch to menu mode	6	Activation key for digital backwards counter with target time setting, adjustable from 1 minute to 99 days
7	Main switch	8	Display of digital backwards counter with target time setting, adjustable from 1 minute to 99 days
9	Air flap position display	10	Activation key for air flap position adjustment
11	Turn control for setpoint adjustment	12	Confirmation key (applies setting made with the turn control)
13	Activation key for the appliance state	14	Appliance state and programme display
15	Activation key for the appliance state	16	Activation key for adjustment of temperature monitoring
17	Temperature monitoring display	18	Graphic representation
19	Activation key for graphic representation		

6.4.2 Basic Operation

In general, all settings are made as follows:

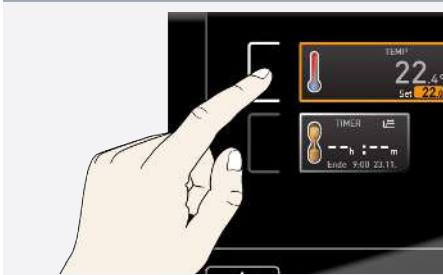

Activate the desired parameter (e.g. temperature):

- To do so, press the activation key to the left or right of the respective display.
 - ⇒ The activated display is outlined in colour, the other displays are dimmed.
 - ⇒ The setpoint value (Set) is highlighted in colour.

	<p>2. You can adjust the setpoint (e.g. to 180 °C) by turning the turn control anti-clockwise or clockwise.</p>
	<p>3. Save the set value by pressing the confirmation key. ⇒ The display returns to normal and the appliance starts controlling with reference to the defined setpoint value. ⇒ Additional parameters and functions can be set accordingly.</p>
	<p>If no new values are entered or confirmed for approx. 30 seconds, the appliance automatically restores the former values.</p>
	<p>If you want to discard the settings: 4. Press the activation key on the left or right of the display that you want to exit. ⇒ The appliance restores the former values. ⇒ Only the settings that you have saved by pressing the confirmation key will be applied.</p>

6.5 Operating Modes

Manual mode

The appliance runs continuously with the values set at the ControlCOCKPIT.

- See ▶6.5.1 Manual Mode

Timer mode

Operation with digital backwards counter with target time setting, adjustable from 1 minute to 99 days (Timer): The appliance runs at the values set until the set time has elapsed.

- See ▶6.5.2 Digital Backwards Counter

Programme Mode

The appliance automatically runs programme sequences which have been defined using AtmoCONTROL software at a computer / laptop and then transferred to the appliance from a USB stick or via Ethernet.

- See ▶6.5.3 Programme Mode

Remote control mode

Via remote control

- See ▶8.3.8 Remote Control

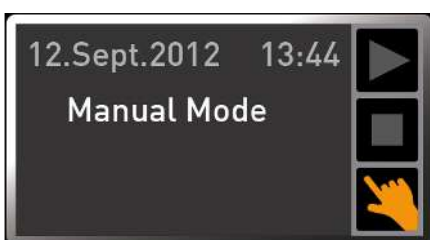

The status display shows the current operating mode or operating state of the appliance. The current operating state is indicated by colour and text display:

- ▶ Appliance is in programme mode
- Programme stopped
- ✋ Appliance is in manual mode

The example on the right shows the appliance in manual mode, as indicated by the coloured hand symbol.

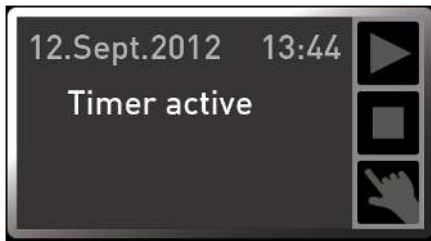





When the appliance is in timer mode, Timer active is displayed.



When the appliance is in remote control mode, the  symbol appears in the temperature display.

See also

-  Manual Mode [▶ 29]
-  Digital Backwards Counter [▶ 30]
-  Programme Mode [▶ 31]
-  Remote Control [▶ 47]

6.5.1 Manual Mode

In this operating mode, the appliance runs continuously with the values set on the ControlCOCKPIT.



In manual and timer mode, the door on the greyroom side (ControlCOCKPIT side) is always unlocked if equipped with mutual door locking and is locked on the cleanroom side.

As described in chapter ▶6.4.2 Basic Operation, you can set the following parameters after pressing the corresponding activation key (in any sequence):

Temperature



Heating operation is indicated by the  symbol.

You can display the temperature in °C or °F.

The setting range depends on the appliance (see ▶3.6 Nameplate and ▶3.7 Technical Data).

Air flap position

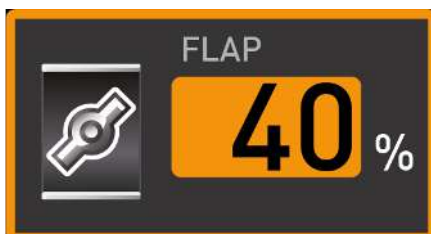

Setting range: 0% (closed, recirculating operation) up to 100% (fully open, fresh air operation) in 10% increments.

Fan speed



Adjustment options: 0 to 100% in 10% increments

See also

- ▣ Basic Operation [▶ 27]
- ▣ Nameplate [▶ 13]
- ▣ Technical Data [▶ 14]

6.5.2 Digital Backwards Counter

	<p>In timer mode, you can adjust the time the appliance runs at the set value. The appliance has to be in manual operating mode for this.</p> <p>Up to a duration of 23 hours 59 minutes, the time is displayed in hh:mm (hours:minutes) format. For 24 hours and more, the format dd:hh (days:hours) is used. The maximum duration is 99 days and 00 hours.</p>
	<ol style="list-style-type: none"> 1. Press the activation key to the left of the timer display. ⇒ The timer display is activated.
	<ol style="list-style-type: none"> 2. Turn the turn control until the desired duration is displayed. ⇒ The anticipated end time is shown beneath, in smaller digits.
	<ol style="list-style-type: none"> 3. Press the confirmation key to confirm. ⇒ The display now shows the remaining time in large digits and the anticipated end time in smaller digits beneath. ⇒ The status display shows "Timer active".
	<ol style="list-style-type: none"> 4. Now, as described in ▶6.4.2 Basic Operation, set the individual reference values to be used by the appliance during operation. ⇒ The change takes effect immediately.
	<p>The set values can be changed at any time while the timer runs down.</p>
	<p>In Setup, you can choose if the timer should run setpoint-dependent or not, in other words, whether the timer should not start until a tolerance band around the setpoint temperature is reached or if it should start right after activation.</p> <p>The symbol on the timer display indicates that the timer is setpoint-dependent.</p>



Once the timer has elapsed, the display shows 00h:00m.

- All functions are switched off.
- In addition, an alarm sounds, and can be turned off by pressing the confirmation key.

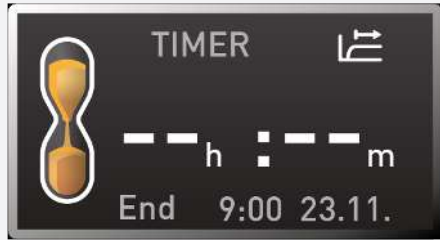

5. To switch off the timer, press the activation key again to display the timer.
6. Turn the turn control to reduce the runtime until --:-- is displayed.
7. Press the confirmation key to apply the setting.

See also

📖 Basic Operation [▶ 27]

6.5.3 Programme Mode

NOTICE



A description of how to create and save programmes can be found in the separate AtmoCONTROL software manual.

In this operating mode, programmes saved in the appliance can be started with different combinations of individual parameters with offset timings which the appliance then automatically processes in sequence.

These programmes are not created directly at the appliance but externally at a computer / laptop using the AtmoCONTROL software then transferred to the appliance using the provided USB storage medium or via Ethernet.



If the configuration has a mutual door locking system, when creating a programme for UFTS in AtmoCONTROL the door lock symbol must be inserted at the start with the setting "Locked".

Starting a programme



1. Press the activation key to the right of the status display.
 - ⇒ The current operating state is highlighted automatically, in this example **manual mode** (👉).

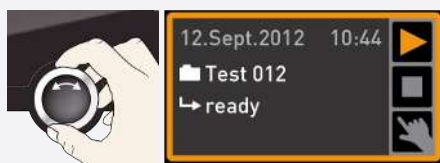

2. Turn the turn control until the ▶ start symbol is highlighted.
 - ⇒ The currently available programme is displayed.

i Only the programme currently selected in the menu and shown in the display can be used. If you want to run another programme, you need to activate it in the menu first (description in ▶8 Menu Mode).

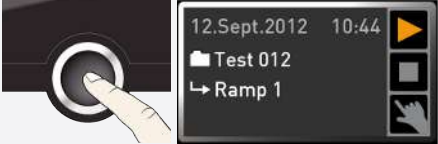

3. To start the programme, press the confirmation key.
⇒ The programme is executed.

The display shows:

- the programme name
- the name of the first programme segment
- the current cycle (in case of loops)

i You cannot change any parameters at the appliance while a programme is running. However, you can still use the displays **ALARM** and **GRAPH**.



If the configuration has a mutual door locking system, the door on the greyroom side is locked when starting the programme, so that both doors are interlocked. This process can last up to four seconds. The transfer key on the cleanroom side lights up green for the entire duration of the programme.

Cancelling a programme

You can cancel an active programme at any time:



1. Press the activation key to the right of the status display.
⇒ The status display is automatically highlighted.

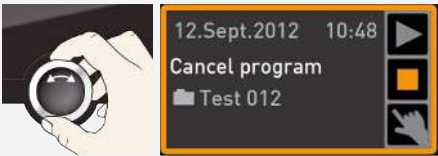

2. Turn the turn control until the stop symbol ■ is highlighted.

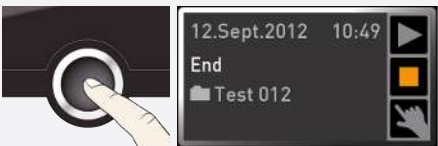

3. Press the confirmation key to confirm.
⇒ The programme is cancelled.

i A cancelled programme cannot be resumed at the point it was cancelled. It must be restarted from the beginning.

End of programme

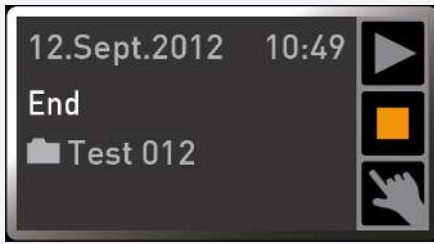

The **End** display appears once the programme has finished normally.



If equipped with mutual door locking system, the door on the cleanroom side unlocks after the programme has finished and the transfer key starts flashing. The door on the greyroom side remains locked.



The door on the cleanroom side can now be opened. To lock the cleanroom side again, press the transfer key until the locking bolt moves down. This causes the door on the cleanroom side to lock and the door on the greyroom side is unlocked after approx. 4 seconds. This prevents both doors from being opened simultaneously.

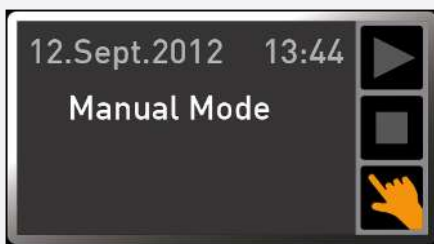

You can now

- restart the programme as described,
- select another programme to run in menu mode (see ▶8.6 Programme) and run it as described,
- return to manual mode. To do so, reactivate it by pressing the activation key next to the status display, then turn the turn control until the hand symbol  is highlighted in colour and press the confirmation key.

See also

-  Menu Mode [▶ 42]
-  Programme [▶ 50]

6.6 Monitoring Function

6.6.1 Temperature Monitoring

The appliance is equipped with multiple overtemperature protection in accordance with DIN 12880. This is designed to prevent damage to the chamber load and/or appliance in case of a malfunction:

- electronic temperature monitoring (TWW/TWB)
- automatic temperature monitor (ASF)
- mechanical temperature limiter (TB)



The electronic temperature monitoring measures the monitoring temperature via a separate Pt100 temperature sensor in the chamber. Temperature monitoring settings are made via the **ALARM** display. The settings made apply to all operating modes.



If temperature monitoring has been triggered, this is indicated by the temperature display: the actual temperature is highlighted in red and a warning symbol **▲** is shown. The type of temperature monitoring that has been triggered is shown beneath the temperature (see ▶ 7 Malfunctions, Warning and Error Messages).

The individual monitoring functions will be presented in more detail first, followed by a description of how to set the temperature monitoring.

i

If the acoustic signal has been activated at Alarm in menu mode (▶ 8.7 Acoustic Signals, which is indicated by the speaker symbol **🔊**), the alarm will be accompanied by an intermittent acoustic signal.

The acoustic alarm can be temporarily switched off by pressing the confirmation key until the next alarm event occurs.

See also

- 📖 Malfunctions, Warning and Error Messages [▶ 39]
- 📖 Acoustic Signals [▶ 51]

6.6.2 Electronic Temperature Monitoring (TWW)

The manually set min and max monitoring temperature of the electronic overtemperature protection is monitored by a temperature selector switch (TWW) protection class 3.1 acc. to DIN 12880 (or temperature selector switch (TWW) protection class 3.1 for UIS appliances).

i

If the manually set max monitoring temperature is exceeded, the TWW takes over the closed-loop temperature control and begins to regulate with reference to the monitoring temperature.

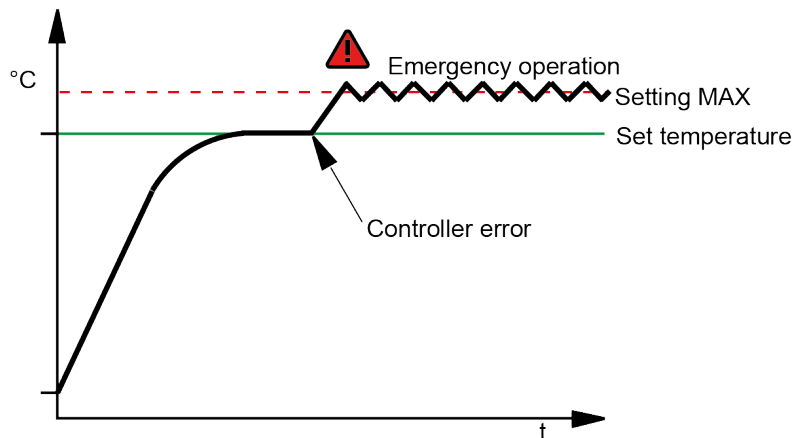

6.6.3 Temperature Selector Limiter (TWB)



In programme mode, the current programme is resumed for TWB alarms of up to 15 minutes. If the alarm is active for more than 15 minutes, the programme is cancelled.

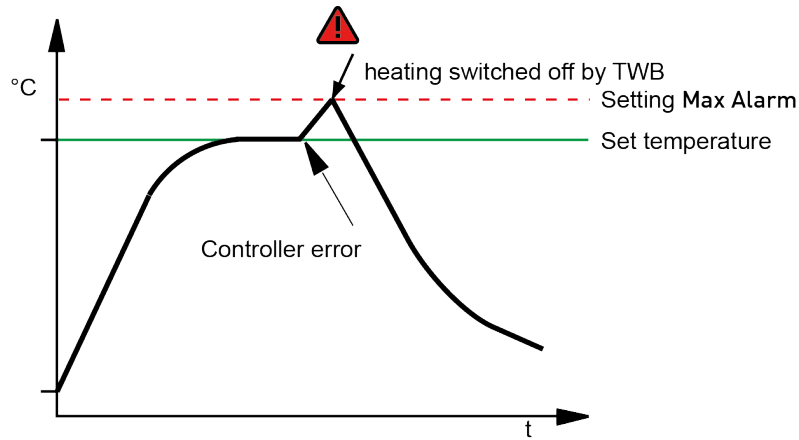

6.6.4 Automatic Temperature Monitor (ASF)

ASF is a monitoring device that automatically follows the set temperature setpoint within an adjustable tolerance band.

The ASF – if switched on – is automatically activated as soon as the actual temperature value reaches 50% of the set tolerance band of the setpoint for the first time (section A).

When the temperature leaves the set tolerance band around the setpoint – e.g. if the door is opened during operation (section B) – the alarm is triggered. The ASF alarm is automatically deactivated as soon as 50% of the set tolerance band of the setpoint has been reached again (section C).

If the temperature setpoint is altered, the ASF is automatically disabled temporarily (section D), until it is once again within the tolerance range of the new temperature setpoint (section E).

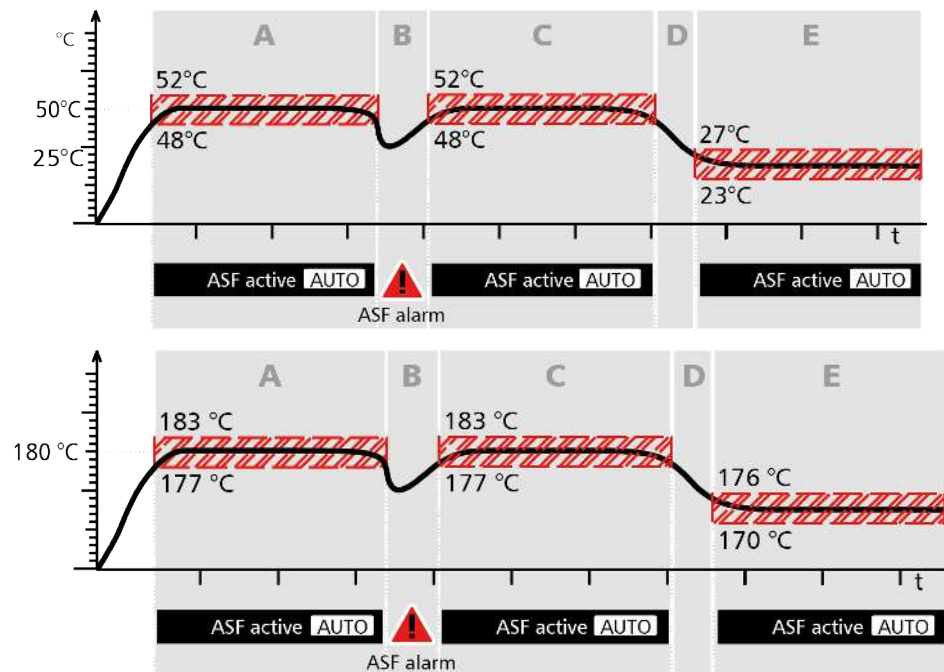

6.6.5 Mechanical Temperature Monitoring: Temperature Limiter (TB)

The appliance is equipped with a mechanical temperature limiter (TB) of protection class 1 in accordance with DIN 12880.

If the electronic monitoring unit fails during operation and the factory-set maximum temperature is exceeded by approx. 20 °C, the temperature limiter, as the final protective measure, switches off the heating permanently.

6.6.6 Adjusting the Temperature Monitoring

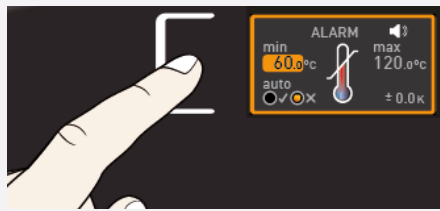

1. Press the activation key to the left of the **ALARM** display.
⇒ The temperature monitoring setting is automatically activated .

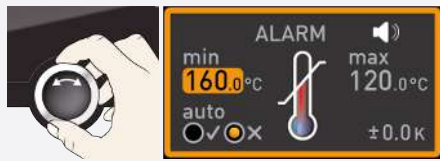

2. By turning the turn control, adjust the desired lower alarm limit.



The lower alarm limit cannot be higher than the upper alarm limit. If no undertemperature protection is required, set the lowest temperature.

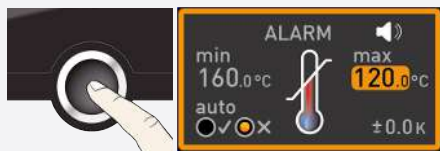

3. Press the confirmation key to confirm.
⇒ The **max** display (overtemperature protection) is activated.

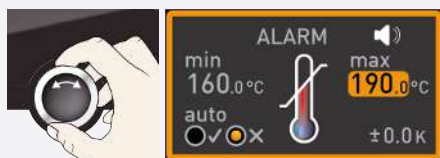

4. By turning the turn control, adjust the desired upper alarm limit.



The monitoring temperature must be set sufficiently high above the maximum setpoint temperature. We recommend 5 to 10 K.

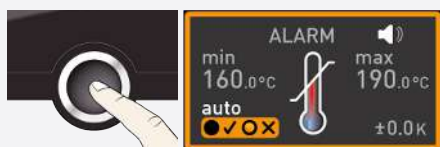

5. Press the confirmation key to apply the setting for the upper alarm limit.
⇒ The setting of the automatic temperature monitor (ASF) is automatically activated (**auto**).



6. With the turn control select ON (✓) or OFF (X).

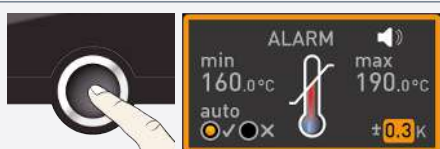

7. Press the confirmation key to confirm.
⇒ The ASF tolerance band setting is activated.



8. With the turn control, select the required tolerance band.

i We recommend a tolerance band of 5 to 10 K.

 9. Press the confirmation key to confirm.
⇒ Temperature monitoring is now active.

i In menu mode you can set, whether an alarm should be accompanied by an acoustic signal (see ▶8.7 Acoustic Signals).

See also

Acoustic Signals [▶ 51]

6.7 Graph

i The **GRAPH** display provides an overview of the chronological sequence of the set values and the actual values as a curve.
■ Press the activation key again to close the graphic display.

6.7.1 Temperature Curve

 1. Press the activation key to the right of the **GRAPH** display.
⇒ The display is enlarged and the temperature curve is displayed.

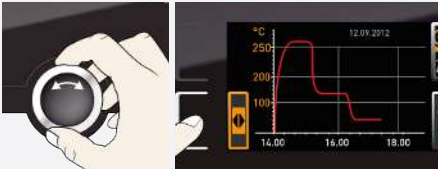
 2. To change the time range to display press the activation key next to the ◀▶ arrow symbols.
⇒ The time range to display can now be displaced by turning the turn control.

To zoom in or out in the graph:

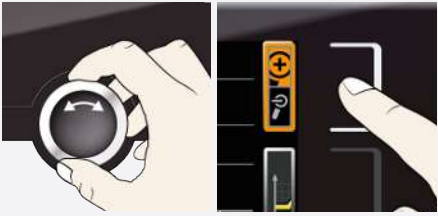
 3. Press the activation key next to the magnifying glass symbol.
4. With the turn control, select if you want to zoom in or out (+/-).
5. and confirm your selection by pressing the confirmation key.
⇒ To close the graphic display, press the activation key again.

6.8 Ending Operation

WARNING



Hot surfaces

Depending on the operating situation, the unit and the load may be hot. Contact with hot surfaces may have serious health consequences due to burns!

- Allow the unit to cool down.
- Wear heat-resistant protective gloves when carrying out work.
- Check the temperature of surfaces before touching them.

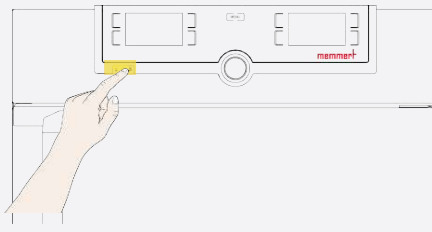

1. Switch off the active unit functions (reset setpoint values).
2. Remove the chamber load.
3. Switch off the unit at the main switch.
4. If the configuration includes mutual door locking, the door on the greyroom side (ControlCOCKPIT side) is always unlocked and the door on the cleanroom side is locked.

7. Malfunctions, Warning and Error Messages

DANGER



Risk of electric shock from unauthorised troubleshooting

Errors requiring intervention inside the unit may only be rectified by qualified electricians.

- Follow the measures listed in the event of a malfunction.
- Contact Memmert International After Sales.

Do not try to rectify appliance errors yourself; instead you should contact Memmert International After Sales or an authorised customer service point.

In case of enquiries, please always state the model and appliance number on the nameplate (see ▶3.6 Nameplate).

See also

Nameplate [▶ 13]

7.1 Warning Message of the Monitoring Function



If the acoustic signal has been activated at Alarm in menu mode (▶8.7 Acoustic Signals, which is indicated by the speaker symbol), the alarm will be accompanied by an intermittent acoustic signal.

The acoustic alarm can be temporarily switched off by pressing the confirmation key until the next alarm event occurs.

See also



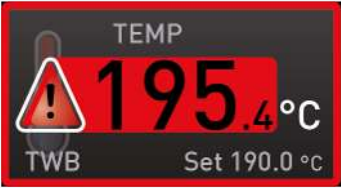

Acoustic Signals [▶ 51]

7.1.1 Temperature Monitoring

Description	Cause	Action
Temperature alarm and ASF is displayed 	Automatic temperature monitor (ASF) has triggered.	<ul style="list-style-type: none"> ■ Check that the door is closed ■ Close door ■ Increase ASF tolerance band ■ If the alarm persists: Notify customer service
Temperature alarm and TWW is displayed 	Temperature selector switch (TWW) has taken over the heating control.	<ul style="list-style-type: none"> ■ Increase the difference between the monitoring temperature and the set point temperature – i.e. either increase the max. value of the temperature monitoring or reduce the set point temperature ■ If the alarm persists: Notify customer service
Temperature alarm and TB is displayed 	Mechanical temperature limiter (TB) has switched off the heating permanently.	<ul style="list-style-type: none"> ■ Switch off the appliance and allow it to cool down ■ Contact customer service and have the fault rectified (e.g. replace the temperature sensor)

Description	Cause	Action
Temperature alarm and TWB is displayed 	Temperature selector limiter (TWB) has switched off the heating permanently.	<ul style="list-style-type: none"> Switch off the alarm by pressing the confirmation button Increase the difference between the monitoring temperature and the set point temperature – i.e. either increase the max. value of the temperature monitoring or reduce the set point temperature If the alarm persists: Notify customer service

7.2 Malfunctions, Operating Problems and Unit Errors

Error description	Cause of errors	Rectifying errors
Displays are dark 	External power supply was interrupted. Miniature fuse, appliance fuse or power module faulty.	<ul style="list-style-type: none"> Check the power supply Notify customer service
Displays do not activate 	Appliance locked by USER ID. Appliance is in programme, timer or remote control mode ("Write" or "Write + Alarm" mode).	<ul style="list-style-type: none"> Unlock with USER ID Wait for the programme or timer to end or switch off the remote control
Appearance of displays suddenly changes	Appliance is in the "wrong" mode.	<ul style="list-style-type: none"> Press the MENU key to switch to the operating or menu mode
Door cannot be opened	Negative pressure in appliance	<ul style="list-style-type: none"> Set the atmospheric pressure
Error message T:E-3 in the temperature display 	Temperature working sensor faulty. Monitoring sensor performs the measuring function.	<ul style="list-style-type: none"> The appliance can continue to be operated for a short time Notify customer service as soon as possible
Error message AI E-3 in the temperature display 	Temperature monitoring sensor faulty. Working sensor performs the measuring function.	<ul style="list-style-type: none"> The appliance can continue to be operated for a short time Notify customer service as soon as possible
Error message E-3 in the temperature display 	Working and monitoring sensor faulty.	<ul style="list-style-type: none"> Switch off appliance Remove load Notify customer service

Error description	Cause of errors	Rectifying errors
Start animation after switching on appears in a colour other than white ■■■.	Cyan ■■■: not enough storage space on the SD card.	■ Notify customer service
	Red ■■■: System files could not be loaded.	
	Orange ■■■: The fonts and images could not be loaded.	

7.2.1 Power Failure

⚠ WARNING



Hot surfaces

Depending on the operation performed, the surfaces in the chamber and the chamber load may still be very hot after a power failure. Additionally, depending on the duration of the power failure, the appliance might heat up again after the power supply has been restored. Touching these surfaces can cause burns.

- Wear heat-resistant protective gloves or wait until the appliance cools down first.

In case of a power failure, the unit operates as follows:

In manual mode

After the power supply has been restored, operation is continued with the parameters set. The time and duration of the power failure are documented in the log memory.

In timer or programme mode

In case of an interruption of the power supply of less than 60 minutes, the current programme is continued from the point at which it was interrupted. For longer interruptions of the power supply, all appliance functions are switched off.

After the power supply has been restored, the timer always starts again.

In remote control mode

The previous values are restored. If a programme has been initiated via remote control, it is continued.

8. Menu Mode

In menu mode, you can make basic settings, load programmes and export protocols, as well as adjust the appliance.



Before changing the menu settings, read the description of the respective functions on the following pages to avoid possible damage to the appliance and/or chamber load.

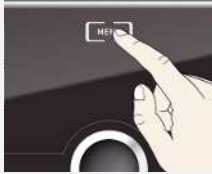

- ▶ To enter Menu mode, press the **MENU** key.
- ⇒ The appliance then returns to operating mode. Only changes applied by pressing the confirmation key are saved.
- ⇒ To exit the menu mode at any time, press the **MENU** key again.

8.1 Overview

Press the **MENU** key to toggle between displays in Menu mode:

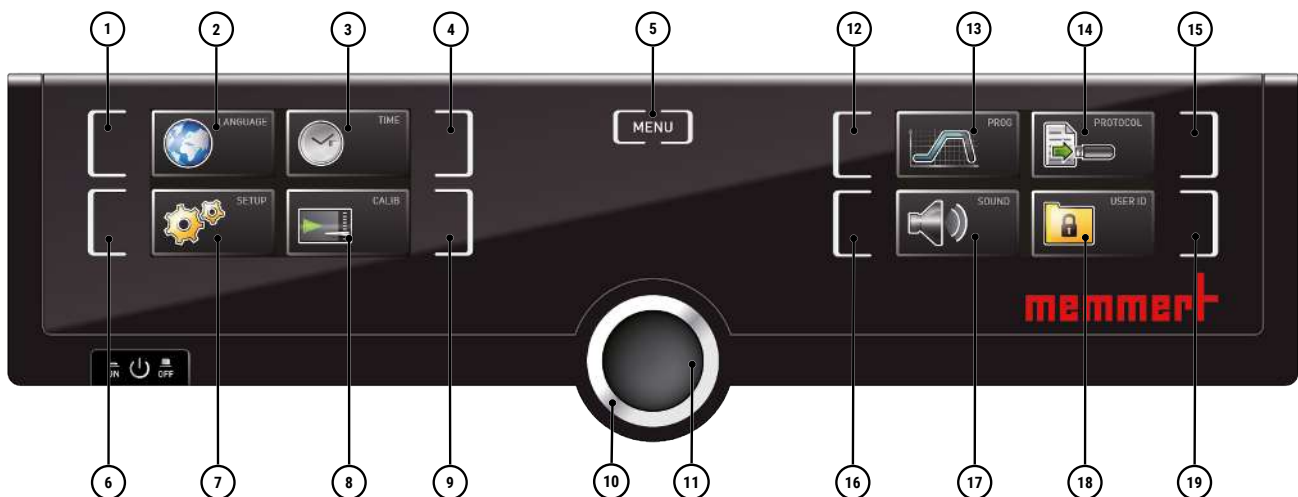

1 Language selection activation key	2 Language selection display
3 Date and time display	4 Date and time setting activation key
5 Exit menu mode and return to the operating mode	6 Setup activation key (basic appliance settings)
7 Setup display (basic appliance settings)	8 Adjustment display
9 Adjustment activation key	10 Turn control for adjustment
11 Confirmation key (applies setting made with the turn control)	12 Programme setup activation key
13 Programme setup display	14 Protocol display
15 Protocol activation key	16 Acoustic signal adjustment activation key
17 Acoustic signal adjustment display	18 User ID display
19 User ID display activation key	

8.2 Basic Operation in Menu Mode Using the Example of Language Selection

In general, all settings in Menu mode are made in the same way as operating mode: Activate the respective display, use the turn control for setting and press the confirmation key to apply the change.

A more detailed description of what you need to do is provided below, using the example of language selection. All other settings can be made accordingly. The possible settings are described below.

	<p>If no new values are entered or confirmed for approx. 30 seconds, the appliance automatically restores the former values.</p>
	<p>Activate the desired setting (in this example the language):</p> <ol style="list-style-type: none"> To do so, press the activation key to the left or right of the respective display. ⇒ The activated display is enlarged.
	<ol style="list-style-type: none"> If you want to discard the settings or exit the dialogue, press the activation key again. ⇒ The appliance returns to the menu overview. ⇒ Only the settings that you have saved by pressing the confirmation key will be applied.
	<ol style="list-style-type: none"> Select the desired new setting, e.g. Spanish (ESPAÑOL) using the turn control.
	<ol style="list-style-type: none"> Save the setting by pressing the confirmation key.
	<ol style="list-style-type: none"> To return to the menu overview, press the activation key again.
	<p>You can now</p> <ul style="list-style-type: none"> activate another menu function by pressing the corresponding activation key or return to the operating mode by pressing the MENU key.

8.3 Setup

8.3.1 Overview

In the **SETUP** display, you can set the following parameters:

- the IP address and subnet mask of the appliance's Ethernet interface (for connection to a network)
- The units of the temperature display (°C or °F, see ▶8.3.3 Unit)
- The type of temperature monitoring (TWW or TWB, Alarm Temp; see ▶6.6.1 Temperature Monitoring (only if equipped with a second temperature sensor, option A6))
- The mode of operation of the digital backwards counter with target time setting (Timer Mode, see ▶6.5.2 Digital Backwards Counter)
- The type of shelf (grid or metal panel, see ▶8.3.6 Shelf Type (Grid or metal plate))

- The heat output distribution (see ▶8.3.7 Balance)
- Remote control (see ▶8.3.8 Remote Control)
- Gateway (see ▶8.3.9 Gateway)



If the Setup menu contains more entries than can be displayed, this is indicated by the display “1/2”. This means that there is a second “page” of entries.

To display the hidden entries, use the turn control to scroll beyond the lowest entry. The page display then changes to “2/2”.

See also

- 📄 Unit [▶ 45]
- 📄 Digital Backwards Counter [▶ 30]
- 📄 Shelf Type (Grid or metal plate) [▶ 46]
- 📄 Balance [▶ 46]
- 📄 Remote Control [▶ 47]
- 📄 Gateway [▶ 47]
- 📄 Temperature Monitoring [▶ 33]

8.3.2 IP Address and Subnet Mask

If you want to operate one or more appliances in a network, each appliance must have its own unique IP address for identification. By default, each appliance is delivered with the IP address 192.168.100.100.

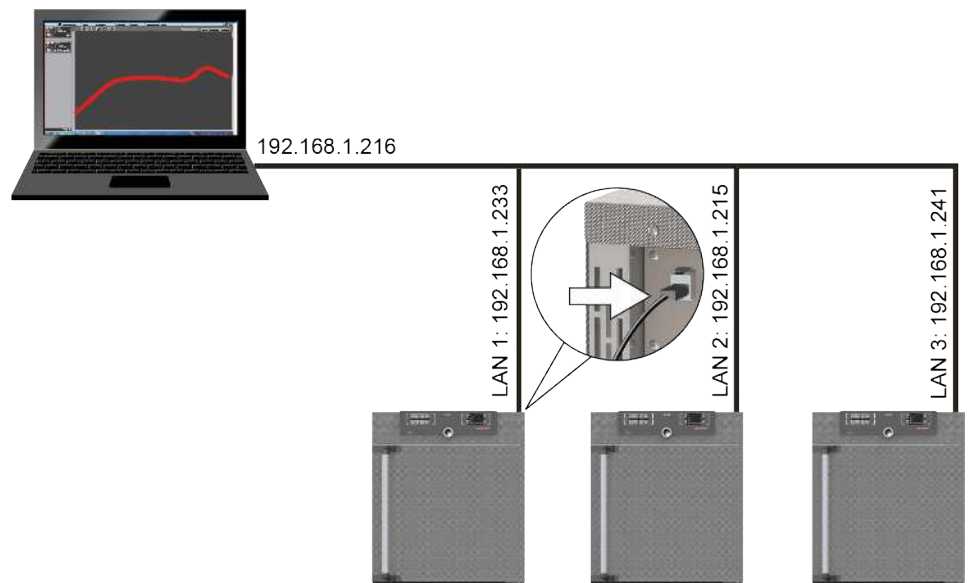

1. Activate the **SETUP** display.

⇒ The **IP address** entry is automatically highlighted.



2. Confirm the selection by pressing the confirmation key.

⇒ The first three digits of the IP address are automatically highlighted.



3. With the turn control, set the new number, e.g. 255.

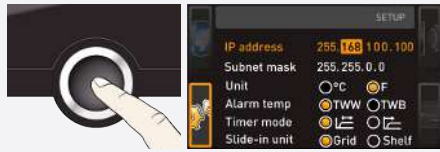

4. Confirm the selection by pressing the confirmation key.
 ⇒ The next three digits of the IP address are automatically marked.
 ⇒ They can now also be set according to the description above.



5. After setting the last three digits, confirm the new IP address by pressing the confirmation key.
 ⇒ The overview is displayed once again.
 ⇒ The subnet mask can be set in the same way.

8.3.3 Unit

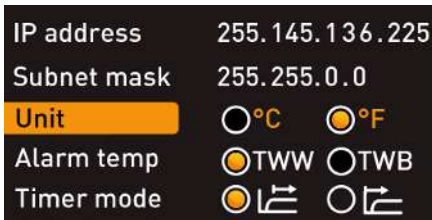

Here, you can choose whether the temperature is displayed in °C or °F.

8.3.4 Temperature Monitoring

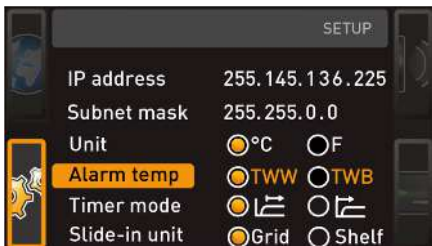

Here, you can choose which temperature protection class in accordance with DIN 12 880:2007-5 should be used (TWW or TWB, description from ▶6.6 Monitoring Function).

See also

- ▣ Monitoring Function [▶ 33]
- ▣ Monitoring Function [▶ 33]

8.3.5 Timer Mode

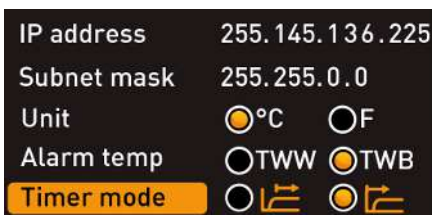

Here, you can choose whether the digital backwards counter with target time setting (see ▶6.5.2 Digital Backwards Counter) should be setpoint-dependent or not – in other words, whether the timer should not start until a tolerance band around the setpoint temperature is reached ⊕ or if it should start right after activation ⊙.

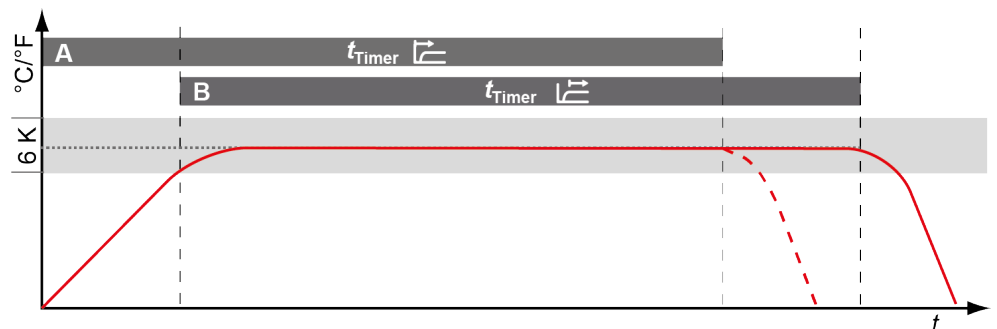



If the temperature goes outside the limits of the tolerance band in setpoint-dependent mode, the timer will be interrupted and only resumed once the temperature is within this band once again.

See also

Digital Backwards Counter [▶ 30]

8.3.6 Shelf Type (Grid or metal plate)

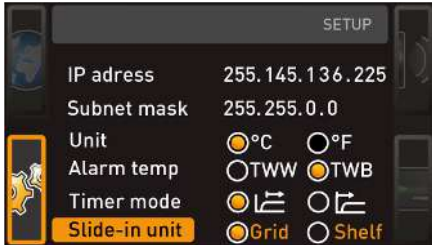

Here, you have to set the type of shelf (grid or metal panel) used. The selection **Metal panel** enables you to adjust the closed-loop control function to the different air flow characteristics in the chamber when using optional shelves instead of the grids provided as standard.

8.3.7 Balance

For appliances of the size 55 and above, application-specific correction of the heat output distribution (balance) between the upper and lower heating groups is possible. The setting range is from -50% to +50%.

Distribution of the heating/cooling power (example):

The -20% (left) setting causes the lower heating elements to work at 20% less power than the upper ones. The +30% (right) setting causes the lower heating elements to work at 30% more power than the upper ones. The 0% setting restores the default distribution.

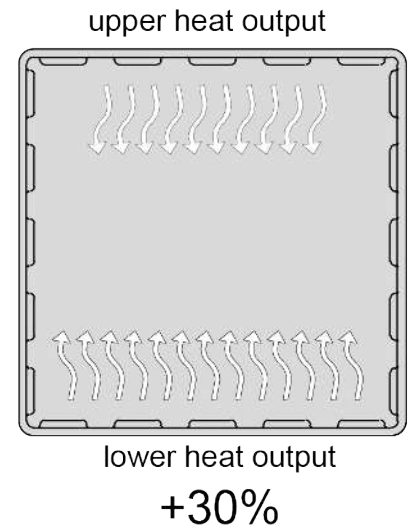
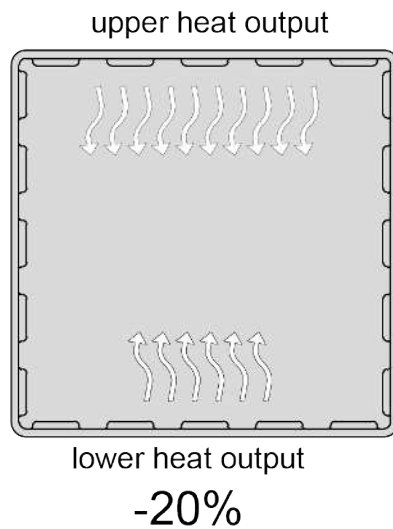

8.3.8 Remote Control



Under the Remote control setup entry, you can set whether the appliance should be controlled via remote control and if so, in which mode. These adjustment options are available:

- Off
- Read Only
- Write + Read
- Write + Alarm



When the appliance is in remote control mode, the  symbol appears in the temperature display. In the settings **Write + Read** and **Write + Alarm**, the appliance cannot be controlled at the ControlCOCKPIT until the remote control has been switched off (**Off** setting) or set to Read Only.

To use the remote control function, programming skills and special libraries are required.

8.3.9 Gateway

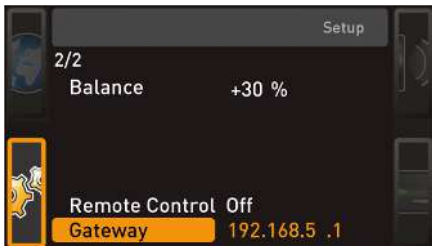

The Gateway setup entry is used to connect two networks with different protocols. The gateway is set the same way as the IP address (see ▶8.3.2 IP Address and Subnet Mask).

See also

- IP Address and Subnet Mask [▶ 44]

8.4 Date and Time

In the **TIME** display, you can set date and time, time zone and summer time. Changes can only be made in manual operating mode.



Always set the time zone (and summer time yes/no) before you set the date and time. Avoid changing the set time after that since this can lead to gaps or overlapping when recording measured values. If you still need to change the time, you should not run a programme immediately before or after doing so.



1. Press the activation key to the right of the **TIME** display.

- ⇒ The display is enlarged and the first adjustment option (**Date**) automatically highlighted.

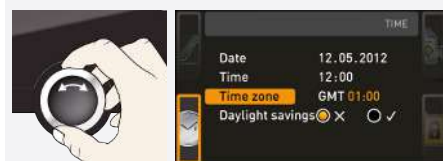

2. Turn the turn control until **Time zone** is highlighted.

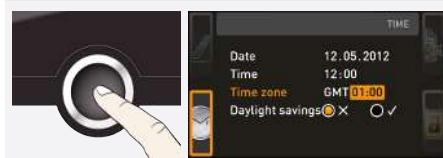

3. Confirm the selection by pressing the confirmation key.

- | | | |
|--|--|--|
| | | <p>4. Set the time zone of the installation site with the turn control (e.g. 00:00 for Great Britain, 01:00 for France, Spain or Germany).</p> <p>5. Confirm the selection by pressing the confirmation key.</p> |
| | | <p>6. With the turn control, select the Summertime entry.</p> |
| | | <p>7. Confirm the selection by pressing the confirmation key.
⇒ The adjustment options are highlighted.</p> |
| | | <p>8. Set summertime to off (X) or on (✓) with the turn control – in this case on (✓).</p> <p>9. Save the setting by pressing the confirmation key.</p> |
| | | <p>The changeover between summer and winter time does not take place automatically. For this reason, please remember to adjust the setting at the start and end of the summer time.</p> |
| | | <p>10. Set the date (day, month year) and time (hours, minutes).</p> <p>11. Confirm the setting by pressing the confirmation key.</p> |

8.5 Calibrate

NOTICE



To guarantee problem-free closed-loop control, we recommend calibrating the appliance once a year.

8.5.1 Temperature Calibration

The appliances are temperature calibrated and adjusted at the factory. If readjustment is necessary – for example due to the influence of the chamber load – the appliance can be calibrated for the specific customer using three possible calibration temperatures:

- Cal1 Temperature calibration at low temperature
- Cal2 Temperature calibration at medium temperature
- Cal3 Temperature calibration at high temperature



For temperature calibration, you will need a calibrated reference instrument.

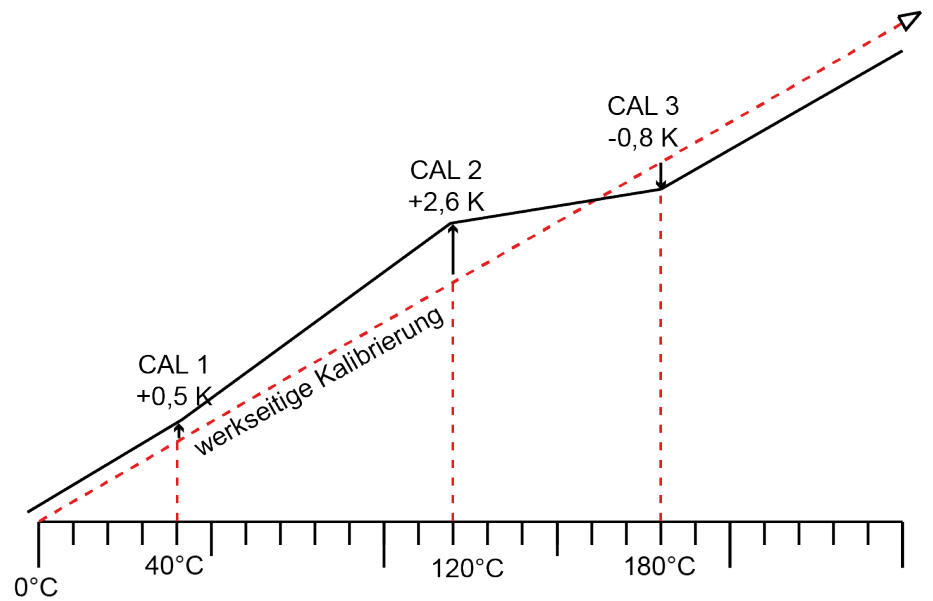

Example: Temperature deviation should be corrected



1. Press the activation key to the right of the **CALIB** display.

⇒ The display is enlarged and the temperature adjustment option is automatically highlighted.



2. Press the confirmation key repeatedly, until the calibration temperature Cal2 is highlighted.

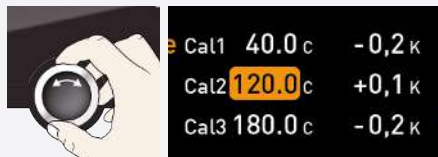

3. With the turn control, set the calibration temperature Cal2 to the specified temperature.

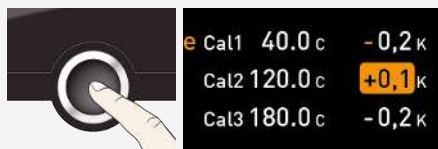

4. Save the setting by pressing the confirmation key.

⇒ The corresponding calibration correction value is automatically highlighted.

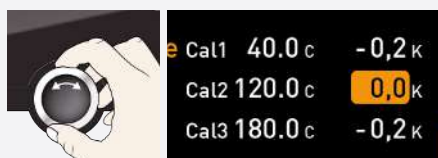

5. Set the calibration correction value to 0.0 K.

6. Save the setting by pressing the confirmation key.

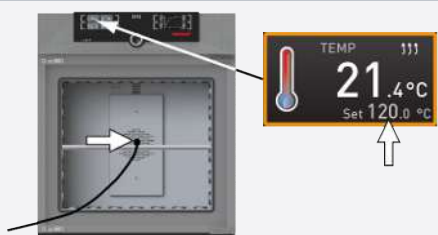

7. Position the sensor of a calibrated reference instrument centrally in the working chamber of the appliance.

8. Close the door.

9. In manual mode, adjust the setpoint temperature.

	<p>10. Wait until the appliance reaches and displays the setpoint temperature.</p> <ul style="list-style-type: none"> ▪ The reference instrument will display the corresponding deviation.
	<p>11. In the SETUP, adjust the calibration correction value Cal2 to the deviation temperature (actual value measured minus setpoint value).</p> <p>12. Save the setting by pressing the confirmation key.</p>
	<p>13. Compare the temperature measured by the reference measurement instrument with the temperature displayed on the appliance.</p> <p>⇒ After the calibration procedure, the temperature measured by the reference instrument should now also be the setpoint temperature.</p>

With Cal1, a further calibration temperature below Cal2, and with Cal3 a temperature above, can be programmed in the same manner. The minimum difference between the Cal values is 20 K.

	<p>If all calibration correction values are set to 0.0 K, the factory calibration settings are restored.</p>
--	--

8.6 Programme

In the **Programme** display, programmes created using the AtmoCONTROL software can be transferred to the appliance and saved on a USB storage medium. Here, you can also select the programme you wish to run (see ▶6.5.3 Programme Mode) and delete programmes.

	<p>If the configuration has a mutual door locking system, when creating a programme for UFTS in AtmoCONTROL the door lock symbol must be inserted at the start with the setting "Locked".</p>
--	---

	<p>1. Insert the USB storage medium on the right side of the ControlCOCKPIT.</p> <p>⇒ You can now use one of the programmes saved on the USB storage medium.</p>
	<p>2. Press the activation key on the left of the Prog display.</p> <p>⇒ The display is enlarged and the Select entry is automatically highlighted.</p> <p>⇒ The programmes available for activation are shown on the right.</p> <p>⇒ The programme currently available for use – in this example Test 012 – is highlighted in orange.</p>
	<p>3. Press the confirmation key to access the Select function.</p> <p>⇒ All available programmes are displayed, including the ones saved on the USB data storage medium (identified by the USB symbol).</p> <p>⇒ The programme currently available for use is highlighted in orange.</p>
	<p>4. With the turn control, select the programme you want to use.</p>

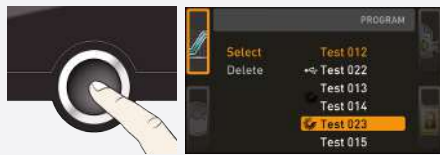

5. Confirm the selection by pressing the confirmation key.
 - ⇒ The programme is now loaded, as indicated by the progress display.



As soon as the programme is ready, **Select** is highlighted once again.

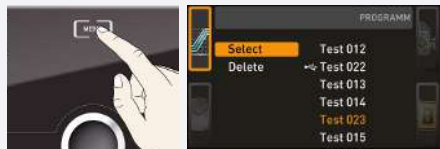

- To start the programme:
6. Return to the operating mode by pressing the **MENU** key again.
 7. Start the programme as described in ▶6.5.3 Programme Mode.



You can now remove the USB storage medium.

To delete a programme:

8. select the programme to be deleted the same way you can select a programme for activation.
9. Select **Delete** with the turn control.

See also

- 📖 Programme Mode [▶ 31]

8.7 Acoustic Signals

In the **SOUND** display, you can define whether or not the appliance should emit acoustic signals and, if yes, for which events:

- on the press of a key
- at the end of a programme
- in the event of an alarm
- if the door is open



1. Press the activation key to the left of the **SOUND** display.
 - ⇒ The display is enlarged.
 - ⇒ The first category (in this case **Keysound**) is automatically highlighted.
 - ⇒ The current settings are shown on the right.

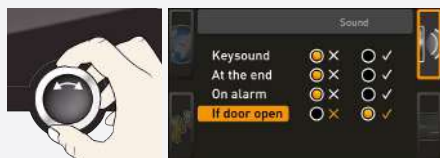

If you want to edit another list entry:

- Turn the turn control until the respective entry – e.g. **if the door is open** (special configuration) – is highlighted in colour.

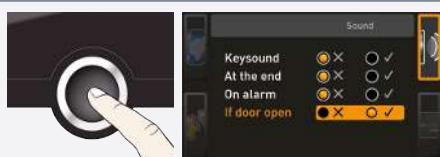

2. Confirm the selection by pressing the confirmation key.
 - ⇒ The adjustment options are automatically highlighted.

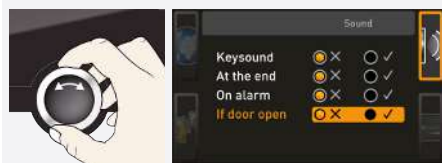

3. With the turn control, select the desired setting – in this example OFF (X).

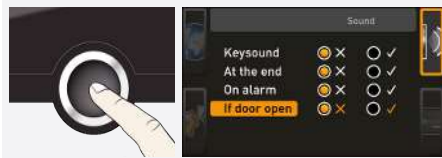

4. Save the setting by pressing the confirmation key.



If an acoustic signal sounds, it can be turned off by pressing the confirmation key.

8.8 Log

NOTICE



The supplied manual for AtmoCONTROL describes how

- to import exported log data into AtmoCONTROL,
- exported log data can be processed further in AtmoCONTROL,
- log data can be read out via Ethernet.

The appliance continually logs all relevant measured values, settings and error messages at 1-minute intervals. The internal log memory is a continuous memory type. The log function cannot be switched off and is always active. The measured data are stored in the appliance, safe from manipulation. If the power supply is interrupted, the time of the power failure and when the power was restored are stored in the appliance.



You can export the log data for different periods to a USB storage medium via the USB interface, or export the data via Ethernet and reimport it in the AtmoCONTROL software for graphic display, print-out or storage.

The log memory of the appliance is not modified or deleted by reading it out.

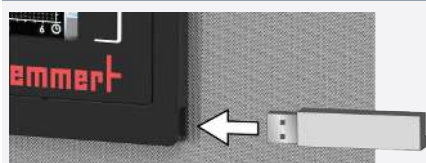

1. Connect the USB storage medium to the port on the right of the ControlCOCKPIT.

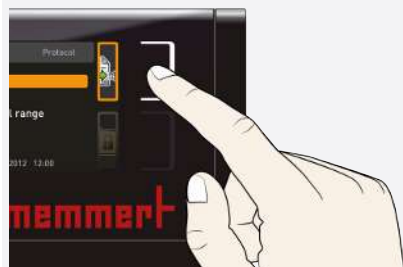

2. Press the activation key on the right side of the **Log** display.

⇒ The display is enlarged and the period **This Month** automatically highlighted.

3. To select another log period, use the turn control.

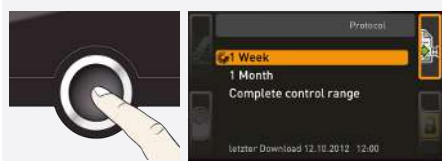

4. Apply the selection by pressing the confirmation key.

⇒ The transfer starts

⇒ and the status bar indicates the progress.



As soon as the transfer is complete, a check mark appears in front of the period selected.

- The USB storage medium can now be removed.

8.9 USER ID

8.9.1 Description

With the USER ID function, you can lock the settings of individual (e.g. temperature) or all parameters, so that they cannot be changed at the appliance by accident or by unauthorised persons.



You can also lock adjustment options in Menu mode (e.g. adjustment of date and time settings).

- If adjustment options are locked, this is indicated by the lock symbol in the respective display.



USER ID data is entered in the AtmoCONTROL software and saved on the USB storage medium. The USB storage medium is thus acting as a key: Parameters can only be locked or unlocked if it is inserted.

A description of how to create a USER ID in AtmoCONTROL is provided in the separate AtmoCONTROL manual.

8.9.2 USER ID Activation and Deactivation

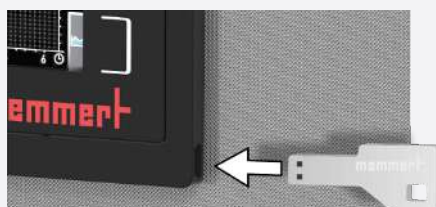

1. Insert the USB storage medium with the USER ID data into the USB port on the right of the ControlCOCKPIT.



2. Press the activation key on the right side of the **USER-ID** display.
 - ⇒ The display is enlarged and the entry **Activate** automatically highlighted.

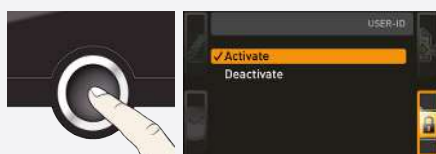

3. Confirm the activation by pressing the confirmation key.
 - ⇒ The new USER ID data are transferred from the USB storage medium and activated.
 - ⇒ As soon as activation is complete, a check mark appears in front of the corresponding entry.

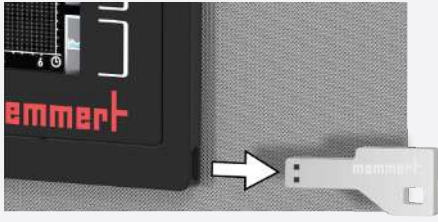

4. Remove the USB storage medium.

⇒ Locked parameters are indicated by the lock symbol on the respective display.



To unlock the appliance,

- insert the USB storage medium,
- activate the **USER ID** display
- and select the **Deactivate** entry.

9. Maintenance and Servicing

⚠ DANGER



Danger of suffocation inside the appliance

If the appliances is a certain size, you can get accidentally locked in, which is potentially life-threatening.

- Do not climb into the appliance.
- Do not carry out cleaning work in the chamber alone.

⚠ DANGER



Live parts

When covers are removed, live parts are exposed and contact with these parts may result in electric shock. Electric shock can have serious health consequences including death.

- Only authorised persons may carry out electrical installation work.
- Before starting work, disconnect the unit from the power supply.
- Ensure that the unit is fully de-energised.
- Secure the unit to prevent it from being switched on again.

⚠ CAUTION



Danger of cuts due to sharp edges

Touching sharp edges on the unit may result in cuts.

- Wear protective gloves during all work.
- Be careful when handling sheet metal parts.

9.1 Cleaning

Interior and metal surfaces

Regular cleaning of the easy-to-clean bath prevents build up of material residues that could impair the appearance and functionality of the stainless steel chamber over time.

The metal surfaces of the waterbath can be cleaned with normal stainless steel cleaning agents. Make sure that no rusty objects come into contact with the interior or with the stainless steel housing. Rust deposits can lead to an infection of the stainless steel. If rust spots appear on the surface of the interior due to impurities, the affected area must be immediately cleaned and polished.

Plastic parts

Do not clean plastic parts of the waterbath with caustic or solvent-based cleaning agents.

Glass surfaces

Glass surfaces can be cleaned with a commercially available glass cleaner.

9.2 Regular Maintenance

Once a year, grease the moving parts of the doors (hinges and lock) with thin silicone grease and check that the hinge screws are not loose.

To guarantee perfect closed-loop control, we recommend calibrating the appliance once a year (see ▶8.5 Calibrate).

See also

- 📄 Calibrate [▶ 48]

9.3 Repairs and Service

Repairs and service work may only be carried out by specialist Memmert personnel and qualified service providers.

NOTICE



Repairs and service work are described in a separate service manual.

10. Storage, Transport and Disposal

10.1 Storage and Transport

The appliance may only be stored and transported under the following conditions:

- in a dry enclosed, dust-free room
- disconnected from the power supply

10.2 Disposal

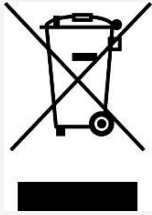

This product is subject to Directive 2012/19/EC on Waste Electrical and Electronic Equipment (WEEE) of the European Parliament and EU Council of Ministers. This unit was placed on the market after 13 August 2005 in countries which have already integrated this Directive into their national laws. It must not be disposed of as normal household waste. For disposal, please contact your dealer or the manufacturer. Any units that are infected, infectious or contaminated with materials hazardous to health are excluded from return. Please also observe all other regulations applicable in this context.

Before disposing of the appliance, please render the door locking mechanism unusable, for example to prevent playing children playing with the appliance and being locked inside.

There is a lithium battery in the ControlCOCKPIT of the appliance. Remove it and dispose of it in accordance with the regulations in your country.

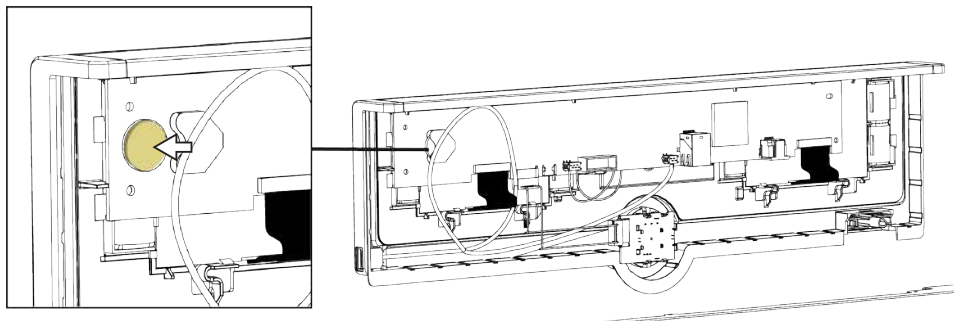

Note for Germany:

- The appliance may not be left at public or municipal collection points.

Notes

Pass-through oven UFTS

Operating manual
D39059 Effective 02/2024
English

