

**memmert**

# Operating manual



**WTB**

WTB Waterbath

# Table of Contents

<b>1. About this Manual</b>	<b>4</b>
<b>2. Safety</b>	<b>6</b>
2.1 Terms and Symbols Used .....	6
2.1.1 Terms Used.....	6
2.1.2 Symbols Used .....	6
2.2 Product Safety and Dangers.....	6
2.3 Requirements to be met by Operating Personnel.....	8
2.4 Responsibility of the Owner .....	8
2.5 Product Use .....	9
2.5.1 Intended Use.....	9
2.5.2 Improper Use .....	9
2.6 Changes and Alterations.....	9
2.7 Behaviour in case of Malfunctions and Irregularities .....	9
2.8 Switching off the Unit in an Emergency.....	10
<b>3. Construction and Description</b>	<b>11</b>
3.1 Design.....	11
3.2 Description of Function .....	11
3.3 Materials .....	11
3.4 Electrical Equipment.....	12
3.5 Connections and Interfaces .....	12
3.5.1 Electrical Connection.....	12
3.6 Nameplate .....	12
3.7 Technical Data .....	13
3.8 Applied Directives and Standards.....	14
3.8.1 Declaration of Conformity.....	14
3.8.2 Material Compliance.....	14
3.9 Ambient Conditions.....	15
3.10 Scope of Delivery .....	15
<b>4. Delivery, Transport and Setting Up</b>	<b>16</b>
4.1 Safety.....	16
4.2 Delivery .....	17
4.3 Transport.....	17
4.4 Unpacking.....	17
4.5 Storage after Delivery .....	17
4.6 Setting Up.....	17
4.6.1 Preconditions.....	18
<b>5. Putting into Operation</b>	<b>19</b>
5.1 Putting into Operation for the First Time.....	19

5.2	Connecting the Unit to the Power Supply .....	19
5.3	Water specifications .....	20
5.4	Filling .....	20
5.5	Switching on Unit .....	21
<b>6.</b>	<b>Operation and Control .....</b>	<b>22</b>
6.1	Home Screen and Settings.....	22
6.2	CustomView .....	23
6.3	Unit Information .....	23
6.4	Values and Unit.....	24
6.5	Emptying .....	24
6.6	Calibration.....	24
<b>7.</b>	<b>Malfunctions, Warning and Error Messages .....</b>	<b>27</b>
7.1	Warning Message of the Monitoring Function .....	27
7.1.1	Temperature Monitoring .....	27
7.2	Malfunctions, Operating Problems and Unit Errors .....	28
7.2.1	Power Failure .....	29
<b>8.</b>	<b>Maintenance and Servicing .....</b>	<b>30</b>
8.1	Cleaning .....	30
8.2	Decontamination.....	31
8.3	Regular Maintenance.....	31
8.4	Repairs and Service.....	31
<b>9.</b>	<b>Storage and Disposal .....</b>	<b>32</b>
9.1	Storage.....	32
9.2	Disposal .....	32

# 1. About this Manual

---

## Purpose and target audience

This manual describes the design, function, transport, operation and maintenance of the product series Waterbaths WTB. It is intended for use by trained personnel employed by the owner who are tasked with operating and/or maintaining the unit.

If you have been tasked with working on the unit, read this manual carefully before starting work. Familiarise yourself with the safety instructions. Only perform work that is described in this manual. If there is anything you do not understand, or if any information is lacking, ask your line manager or contact the manufacturer. Do not take any course of action on your own initiative.

## Versions

The appliances are available in different equipment versions and sizes. If certain features or functions are only available in certain equipment versions, this is indicated at the relevant points in this manual.

The functions described in this manual relate to the most recent firmware version.

Due to the different equipment versions and sizes, the illustrations in this manual may be slightly different to your product. However, the product is identical in terms of its operation and function.

## Further applicable documents

In addition to this manual, please observe the following documents:

- Service manual:  
To carry out service and repair work you will require the separate service manual. Manuals can be requested from Memmert International After Sales or downloaded from [www.memmert.com](http://www.memmert.com).
- Operating manual for accessories  
For accessory parts such as the shaking device and circulating pump device you will require the separate operating manual.

## Retaining and passing on this manual

This operating manual belongs to the unit and must always be kept in a location where it can be easily found by those working with the unit. It is the responsibility of the owner to ensure that persons who work on the unit know where this operating manual is. We recommend always storing it in a safe place near the unit.

Ensure that the manual is not damaged by heat or humidity. If the unit is sold or transported and re-installed at another location, this operating manual must be handed over with the unit. The current version of this operating manual is also available in PDF format at [www.memmert.com](http://www.memmert.com).

## Address and Customer Service

### Manufacturer's address

Memmert GmbH + Co. KG
Äußere Rittersbacher Straße 38   D-91126 Schwabach   Germany
Tel. +49 9122 925-0
E-mail: <a href="mailto:sales@memmert.com">sales@memmert.com</a>
<a href="http://www.memmert.com">www.memmert.com</a>

International After Sales

Memmert GmbH + Co. KG
Willi-Memmert-Straße 90-96   D-91186 Büchenbach   Germany
Tel. +49 9171 9792 911
E-mail: <b>service@memmert.com</b>
<b>www.memmert.com</b>
If you have any queries, please always quote the product number on the nameplate.

Shipping address for repairs





Memmert GmbH + Co. KG
Willi-Memmert-Straße 90-96   D-91186 Büchenbach   Germany
Please contact our customer service before sending appliances for repair or before making returns, otherwise, we have to refuse acceptance of the shipment.

## 2. Safety











### 2.1 Terms and Symbols Used

In this manual and on the unit itself, certain recurring terms and symbols are used to warn you of hazards or give you information that is important in order to prevent injury or damage. To avoid accidents and damage, observe and follow these instructions. These terms and symbols are explained below.

#### 2.1.1 Terms Used

 <b>DANGER</b>	Warns of a dangerous situation that will result directly in death or serious (irreversible) injury.
 <b>WARNING</b>	Warns of a dangerous situation that could result in death or serious physical injury.
 <b>CAUTION</b>	Warns of a dangerous situation that could result in moderate or minor physical injury.
 <b>NOTICE</b>	Warns of damage to property.

#### 2.1.2 Symbols Used

	Do not lift unit		Risk of explosion
	Hot steam		Danger of electrocution
	General warning sign		Flammable substances
	Hot surfaces		Vaporising liquids
	Wear gloves		Disconnect the mains plug
	Observe information in separate manual		

## 2.2 Product Safety and Dangers

The units described in this manual are technically sophisticated, manufactured using high-quality materials and subject to many hours of testing in the factory. They reflect the state of the art and comply with recognised technical safety regulations. However, there are still risks involved, even when the units are used as intended. These are described below.

**⚠ DANGER****Danger due to electric shock**

Penetration of liquid into the unit can cause electric shocks and short circuits.

- Opening the electronics box is prohibited.
- Protect the unit from splashing water.
- Switch off the unit and disconnect the mains plug before cleaning and maintenance work.
- The unit must not be wet cleaned and disinfected. Allow the unit to dry completely before putting it back into operation.

**⚠ DANGER****Risk of electric shock due to damage to the heater**

The heating system can be damaged due to impact or excessive loads on the tray, e.g. heavy objects falling into the tray.

- Check the tray of the appliance for damage before putting it into operation.
- Do not allow heavy objects to drop into the tray.
- When loading the water bath, do not exceed the maximum weight (see ▶3.7 Technical Data).

**⚠ WARNING****Hot tempering medium**

During operation, the tempering medium is heated up to +100 °C. This may lead to burns when coming in contact with skin.

- Please allow the tempering medium to cool down before removing the flat lid.
- Please allow the tempering medium to cool down before removing the load.

**⚠ WARNING****Poisonous or explosive vapours and gases**

When loading the unit with an unsuitable load, poisonous or explosive vapours or gases may be produced. This could cause the unit to explode, and persons could be severely injured or poisoned.

- The unit may only be loaded with materials and substances which cannot form any toxic or explosive vapours at the set temperature and which cannot explode, burst or ignite.

**⚠ WARNING****Fire hazard**

Operating without a tempering medium can cause the unit to overheat and pose a fire hazard.

- Do not operate the waterbath without a tempering medium.
- Always observe the minimum fill level for the tray.

**⚠ WARNING****Hot surfaces**

Depending on the operating situation, the unit and the load may be hot. Contact with hot surfaces may have serious health consequences due to burns!

- Allow the unit to cool down.
- Wear heat-resistant protective gloves when carrying out work.
- Check the temperature of surfaces before touching them.

**⚠ WARNING****Hot drain valve**

When draining the tempering agent, there is a risk of burning and scalding.

- Open the drain valve by turning it 3 to 4 times to the maximum drain speed for the tempering agent. Be careful not to unscrew the drain valve completely.
- Do not discharge hot or boiling water through the drain valve.
- Use heat-resistant / waterproof protective gloves to turn the drain valve on/off.

**⚠ CAUTION****Hot steam**

Hot steam can build up inside the unit. You may be scalded when opening the lid or coming into close contact with the surface of the water.

- Keep a safe distance away from the water's surface when opening the lid and when removing test objects.

**See also**

 [Technical Data](#) [▶ 13]

## 2.3 Requirements to be met by Operating Personnel

The appliance may only be operated and maintained by persons who are of legal age and have been instructed accordingly. It is intended to be operated and maintained by trained personnel employed by the owner.

Repairs may only be performed by qualified electricians. The guidelines in the separate service manual must be observed.

## 2.4 Responsibility of the Owner

The owner of the unit

- is responsible for the flawless condition of the unit and for operating it in accordance with its intended use;
- is responsible for ensuring that persons who operate or service the unit are qualified to do this, have been instructed accordingly and are familiar with these operating instructions;
- must know the applicable guidelines, requirements and operational safety regulations, and train staff accordingly;
- is responsible for ensuring that unauthorised persons cannot access the unit;
- is responsible for ensuring that the maintenance plan is adhered to and that maintenance work is properly carried out;
- has to ensure that the unit and its surroundings are kept clean and tidy, for example through corresponding instructions and inspections;
- is responsible for ensuring that personal protective clothing is worn by operating personnel, e.g. work clothes, safety shoes and protective gloves.



## 2.5 Product Use

### 2.5.1 Intended Use

Memmert waterbaths WTB are used for indirect temperature control of samples or materials. Water should be used as the tempering medium. The temperatures of a wide variety of samples are controlled in a range from approx. 5 °C above room temperature to 100 °C. This can be done in suitable vessels such as test tubes, Erlenmeyer flasks etc., or if the sample is suitable, in direct contact with the tempering medium.

It is not possible to list all possible applications. This is ultimately the responsibility of the operator.

### 2.5.2 Improper Use

Any other use is improper and may result in danger and damage.

The appliance is not explosion-proof (does not comply with the German occupational health and safety regulation VBG 24). Only materials and substances which cannot form any toxic or explosive vapours at the set temperature and which cannot explode, burst or ignite may be put in the appliance.

## 2.6 Changes and Alterations

Unauthorised changes or alterations must not be made to the appliance. Parts that are not approved by the manufacturer must not be mounted or built in.

Unauthorised changes or alterations result in the CE declaration of conformity losing its validity, and the appliance must no longer be operated.

The manufacturer is not liable for any damage, danger or injuries that emanating from unauthorised changes or alterations, or from non-compliance with the provisions in this manual.

## 2.7 Behaviour in case of Malfunctions and Irregularities

### NOTICE



The rocker switch must be freely accessible.



The unit must only be used in a flawless condition. If you, as the operator, notice irregularities, malfunctions or damage, immediately turn off the unit and inform your line manager.



You can find information on troubleshooting in the chapter ▶7 Malfunctions, Warning and Error Messages.

### See also

📖 Malfunctions, Warning and Error Messages [▶ 27]

## 2.8 Switching off the Unit in an Emergency

### ⚠ WARNING



#### Hot surfaces

Depending on the operating situation, the unit and the load may be hot. Contact with hot surfaces may have serious health consequences due to burns!

- Allow the unit to cool down.
- Wear heat-resistant protective gloves when carrying out work.
- Check the temperature of surfaces before touching them.

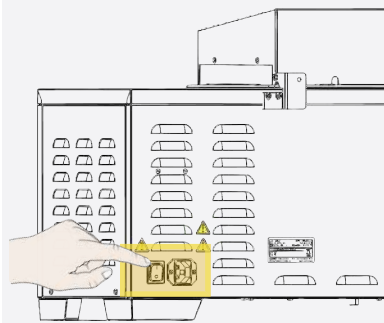

1. Press the main switch on the appliance.
  2. Unplug the mains plug from the power source.
- ⇒ This disconnects the appliance from the power supply at all poles.

### 3. Construction and Description

#### 3.1 Design

Unit overview – front view



1 Handle	2 Lid
3 Safety label "Caution: steam"	4 Safety label "Caution: hot"
5 Touch display 3.5"	6 Drain valve

Unit overview – rear view

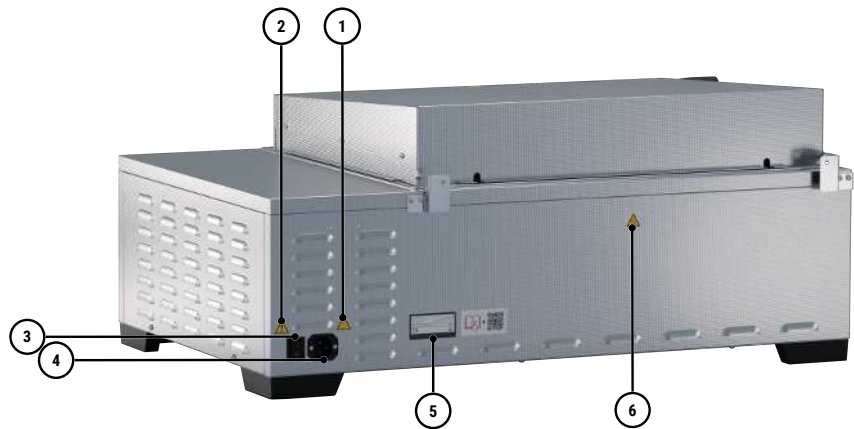

1 Safety label "Caution: voltage"	2 Safety label "General caution"
3 Main switch	4 Mains connection
5 Nameplate	6 Safety label "Caution hot"

#### 3.2 Description of Function

Memmert waterbaths are heated using the Memmert heating concept, which has proven itself over decades. A digital sensor measures the temperature at the waterbath tray. To prevent dry running, the waterbath automatically shuts off if the fill level of the tempering medium is insufficient.

#### 3.3 Materials

Components	Material
Housing (lid + side panels)	Stainless steel 1.4301 – ASTM 304
Interior (tray)	Stainless steel 1.4301 – ASTM 304

Components	Material
Accessories (floor grid, shaking device, basket, insert racks, test tube racks, clamps)	Stainless steel 1.4301 – ASTM 304
Screws and hinges	Stainless steel 1.4301 – ASTM 304
Drain valve	Stainless steel 1.4301 – ASTM 304
Drain system	Stainless steel 1.4301 – ASTM 304
Silicone hose	Silicone – Shore A translucent



The chamber load of the unit must be carefully checked for chemical compatibility with the above materials.

## 3.4 Electrical Equipment

- Operating voltage and current consumption: See ▶3.6 Nameplate or ▶3.7 Technical Data
- Degree of protection IP 20 acc. to DIN EN 60529
- Protection class I, i.e. operating insulation with PE terminal in accordance with EN 60664-1
- Interference suppression acc. to EN 55011 class B
- Device protection fuse: F15H250V
- Electric thermal cutoff fuse: Thermal fuse 200 °C/10 A

### See also

- 📄 Technical Data [▶ 13]
- 📄 Nameplate [▶ 12]

## 3.5 Connections and Interfaces

### 3.5.1 Electrical Connection

#### NOTICE



The waterbath may only be connected to a socket with a PE conductor connection.

This unit is designed for operation on an electrical power system with a maximum system impedance  $Z_{max}$  at the point of transfer (service line) of 0.292 Ohm. The operator must ensure that the unit is only operated on an electrical power system that meets these requirements.

If necessary, ask your local utility company what the system impedance is. Observe the country-specific regulations when making connections (e.g. in Germany DIN VDE 0100 with earth leakage circuit breaker).

## 3.6 Nameplate

The nameplate provides information about the unit model, manufacturer and technical data. It is attached to the back of the unit, on the right near the mains plug.

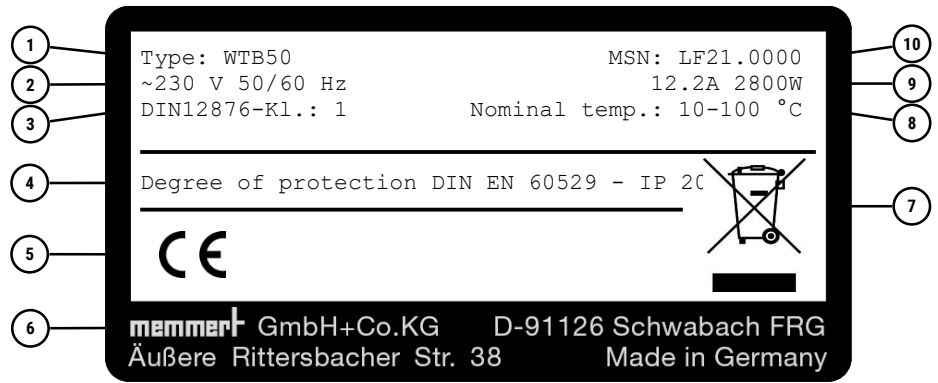

1 Type designation	2 Operating voltage
3 Applied standard	4 Degree of protection
5 CE mark	6 Manufacturer's address
7 Information regarding disposal	8 Nominal temperature
9 Connected loads / power ratings	10 Serial number

### 3.7 Technical Data

Unit sizes				6	11	15	24	35	50
Stainless steel interior	Volume		l	7.5	10	17.1	23.1	37.5	51
	Length	A	mm	277	267	482	472	602	592
	Width	B	mm	217	207	277	267	482	472
	Height	C	mm	200	150	150	200	150	200
Patterned stainless steel housing	Length	D	mm	479	479	749	749	868	868
	Width	E	mm	272	322	272	322	272	322
	Height (with flat lid)	F1	mm	272	322	322	272	272	322
	Height (with sloping lid)	F2	mm	375	425	375	425	425	375
	Max. weight load		kg	12	12	25	25	50	50
Temperature	Operating temperature range		°C	min. 5 above room temperature up to +100 (with lid, depending on ambient pressure)					
	Setting temperature range		°C	+10 up to +100					
	Adjustment precision		°C	0.1					
Electrical data	Power consumption	230 V	W	1,000	1,000	1,420	1,420	2,800	2,800
	Power consumption	115 V	W	1,000	1,000	1,420	1,420	1,800	1800
	Max. current consumption	230 V	A	4,4	4,4	6,2	6,2	12,2	12,2
	Max. current consumption	115 V	A	8,7	8,7	12,4	12,4	15,7	15,7
Packaging data	Net weight		kg	11	12	18	20	30	33
	Gross weight		kg	13	14	21	23	34	37
	Length		mm	579	579	849	849	968	968
	Width		mm	389	389	449	449	525	654
	Height		mm	475	525	475	525	475	525

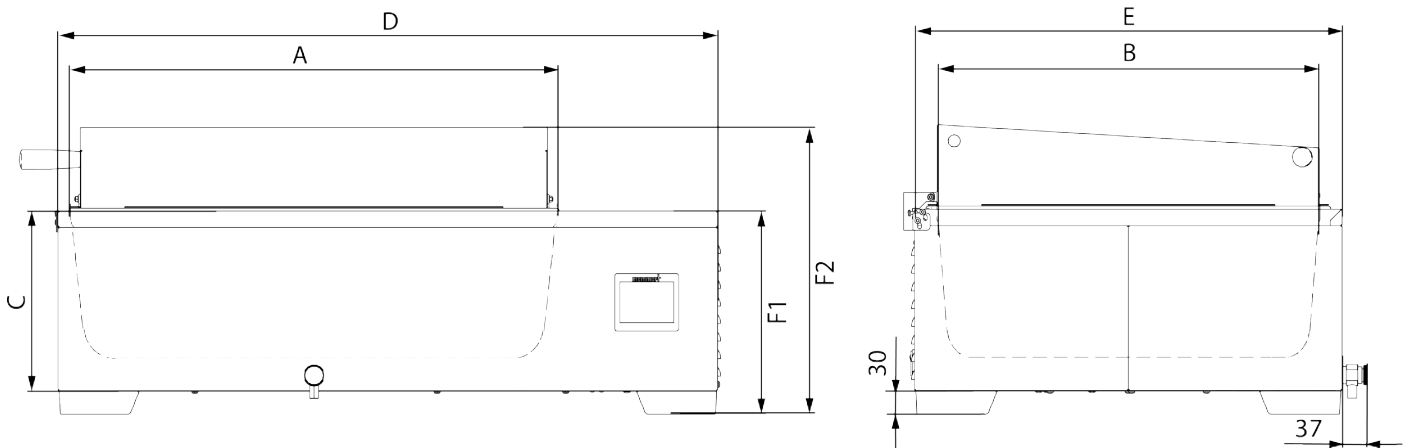

### 3.8 Applied Directives and Standards

#### 3.8.1 Declaration of Conformity



You can download the EC declaration of conformity of the appliance online:

English: <http://www.memmert.com>

German: <http://www.memmert.com>

Based on the standards and guidelines listed below, the products described in this manual carry a CE mark from Memmert:

#### Low Voltage Directive 2014/35/EU

- EN 61010-1:2010, EN 61010-1:2010/A1:2019/AC:2019-04, EN 61010-1:2010/A1:2019; EN IEC 61010-2-010:2020

#### EMC-Directive 2014/30/EU

Directive 2014/30/EU with amendments (Council Directive on the approximation of the laws of the Member States relating to electromagnetic compatibility). Standards complied with:

- EN 61326:2021

#### Directive 2011/65/EU

Directive 2011/65/EU of the European Parliament and of the Council on the restriction of the use of certain hazardous substances in electrical and electronic equipment.

#### 3.8.2 Material Compliance

We confirm that we always draw the attention of our suppliers to the legal restrictions on materials in accordance with our **Company Standard for Material Compliance of Memmert GmbH + Co KG** to ensure they take the original publications by the legislative authority into consideration at all times. The suppliers and deliveries must comply with all material compliance requirements which are relevant or specified in the company standard. By taking this approach, and by making our own observations, we are always able to stay abreast of developments to the best of our knowledge and ability.

In accordance with the REACH regulation and the RoHS guideline, Memmert provides information on the chemical substances in Memmert appliances online at:

[www.memmert.com](http://www.memmert.com)

### 3.8.2.1 REACH information of Memmert GmbH + Co. KG acc. to Regulation (EG) No. 1907/2006, Art. 33

Based on current knowledge, we confirm that products or sub-products containing substances of very high concern (SVHC in the specified components) in the Candidate List with concentrations higher than 0.1 mass % are installed in the appliances we supply:

Appliance component	Substance in the Candidate List SVHC	CAS No.
Seal inserts made of NBR	2,2'-Methylenbis(4-methyl 6-tert-butylphenol)	■ 119-47-1

### 3.8.2.2 RoHS Information of Memmert GmbH + Co. KG acc. to Directive 2011/65/EU and Delegated Directive 2015/863

We confirm that we comply with the substance restrictions in accordance with 2011/65/EU for the supplied products, accessories and spare parts. With regard to the substance lead, we and/or our suppliers make use of the applications exempted from the restriction for lead stated in appendix III in a credible, trustworthy manner.

## 3.9 Ambient Conditions

- The unit must only be used in closed rooms and in the ambient conditions listed below:

Ambient temperature	+5 °C to +40 °C
Air humidity	max. 80% non-condensing
Overvoltage category	II
Contamination level	2
Installation altitude a.s.l.	2000 m a.s.l.
Maximum mains voltage fluctuations	AC 115 V (± 10%) AC 230 V (± 10%)

- The unit may not be used in Ex zones. The ambient air must not contain explosive dusts, gases, vapours or gas-air mixtures. The unit is not explosion-proof.
- Heavy dust production or aggressive vapours in the vicinity of the unit could lead to sedimentation in the interior and, as a consequence, could result in short circuits or damage to electrical parts. For this reason, sufficient measures to prevent large accumulations of dust or aggressive vapours should be taken.

## 3.10 Scope of Delivery

### Standard delivery

- Waterbath
- Mains connection cable
- Sloping lid

### Optional accessories

- Flat lid
- Floor grid
- Clamps, insert racks and test tube racks
- Pumping device
- Factory calibration certificate
- IQ/OQ document with works test data for units

## 4. Delivery, Transport and Setting Up

### 4.1 Safety

**⚠ WARNING**



**Condensation in the electrical components may cause short circuits.**

- Due to temperature fluctuations during transport, condensation may form inside the unit.
- After transporting or storing the unit in humid conditions, remove it from its packaging and allow it to acclimatise for at least 24 hours in normal ambient conditions.
  - Do not connect the unit to the power supply during this time.

**⚠ CAUTION**



**Lifting the appliance incorrectly**

The appliance is heavy. The appliance is heavy, so you could injure yourself if you try to lift it on your own.

- Make sure that a sufficient number of people are on hand to lift and carry the appliance.
- Larger appliances must not be carried, and only transported by pallet truck or forklift truck.

6	11	15	24	35	50

**⚠ CAUTION**



**Crushing hazard due to heavy equipment**

The unit is heavy. Crushing injuries to hands or feet can occur when transporting and installing the unit.

- Wear protective gloves and safety boots.
- Grab hold of the sides of the unit to carry it.

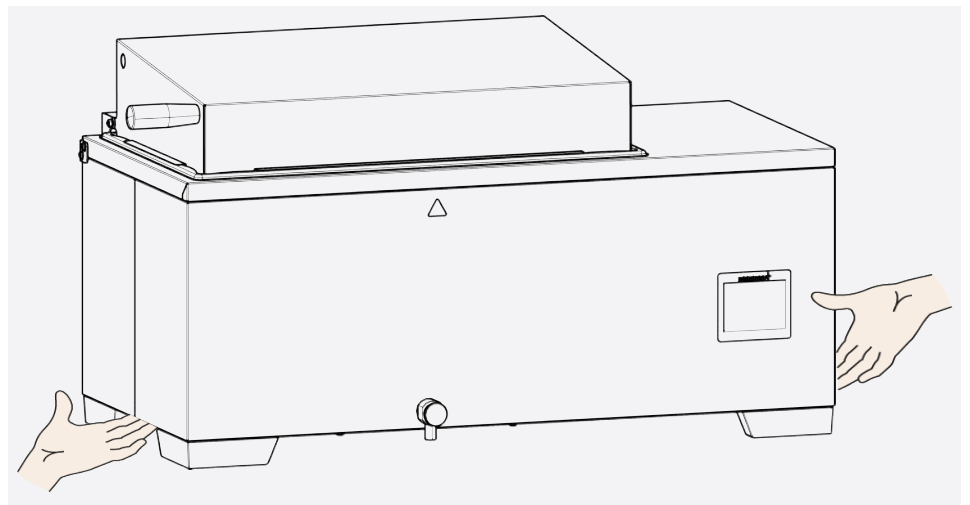



**⚠ CAUTION****Risk of injury due to the unit falling during transport**

The unit could fall over and injure you.

- If a lid is mounted, do not transport the unit while it is open.
- Never tilt the unit and only transport it empty and in the upright position.

## 4.2 Delivery

- The unit is packed in a cardboard box.

## 4.3 Transport

The unit can be transported in different ways depending on its size:

- Carrying; lift the unit at the designated handle positions

## 4.4 Unpacking

- Do not unpack the appliance until you reach the installation site.
- Remove the cardboard packaging by pulling it upwards or carefully cutting along an edge or unscrew and remove wooden crate.

Checking for completeness and transport damage

- Check the delivery note to ensure the delivery is complete.
- Check the unit for damage.

If you notice deviations from the scope of delivery, damage or anything unusual, do not put the unit into operation and inform the haulage company and the manufacturer.

Disposing of packaging material

- Dispose of the packaging material (cardboard, wood, foil) in accordance with the applicable disposal regulations for the respective material in your country.

## 4.5 Storage after Delivery

If the unit is initially to be stored after delivery:

- Observe storage conditions (see ▶9.1 Storage)

**See also**

📄 Storage [▶ 32]

## 4.6 Setting Up

**⚠ CAUTION****Tipping hazard**

If the unit is set up on an uneven surface, it can topple over and injure you or other people.

- Always place the unit on an even, non-slip surface with sufficient load-bearing capacity.

**⚠ CAUTION**

**Fire hazard**

The surfaces of the unit may overheat during operation and overheat heat-sensitive surfaces in close proximity to the unit.

- Always place the unit on a heat-resistant, fireproof and non-flammable surface and
- maintain the specified clearances around the unit.

#### 4.6.1 Preconditions

- ✓ The installation site must be flat and horizontal and must be able to reliably bear the weight of the unit (see ▶3.7 Technical Data). Place the unit on a heat-resistant, fireproof and non-flammable surface.
- ✓ A 230 V or 115 V power connection must be available at the installation site, depending on the version (see ▶3.6 Nameplate).
- ✓ The clearance from the ceiling must not be less than 75 cm and the side clearance from walls or nearby units must not be less than 30 cm. Sufficient air circulation in the vicinity of the unit must be guaranteed at all times.
- ✓ The waterbath must be positioned so that when the lid is opened there is sufficient clearance from the water surface, as hot steam can build up in the unit.
- ▶ Place the unit in the designated position as shown below.

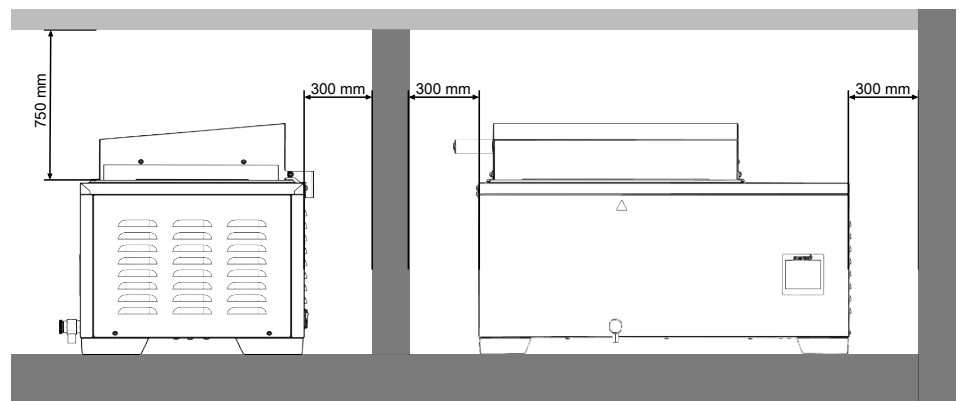
**See also**

- 📄 Technical Data [▶ 13]
- 📄 Nameplate [▶ 12]

## 5. Putting into Operation

### 5.1 Putting into Operation for the First Time

#### ⚠ WARNING



#### Condensation in the electrical components may cause short circuits.

Due to temperature fluctuations during transport, condensation may form inside the unit.

- After transporting or storing the unit in humid conditions, remove it from its packaging and allow it to acclimatise for at least 24 hours in normal ambient conditions.
- Do not connect the unit to the power supply during this time.

#### ⚠ WARNING



#### Hot steam

Hot steam can build up inside the unit when it is opened and when it is switched on and off. You may be scalded when opening the lid or coming into close contact with the surface of the water.

- Keep a safe distance away from the water's surface when opening the lid and when removing test objects.

#### NOTICE



#### When putting the unit into operation for the first time, do not leave it unattended until it has reached a steady state.

- Please observe the national regulations when connecting the unit.
- Observe the connected loads and power ratings (see ▶3.6 Nameplate and ▶3.7 Technical Data).
- Be sure to establish a safe PE conductor connection.

#### NOTICE



Only transport the waterbath when empty.

#### See also

- 📄 Nameplate [▶ 12]
- 📄 Technical Data [▶ 13]

### 5.2 Connecting the Unit to the Power Supply

#### NOTICE



The unit may only be operated with the original mains cable supplied by Memmert. Other mains cables, especially inadequately rated mains cables, must not be used.



When connecting, observe the country-specific regulations (e.g. in Germany DIN VDE 0100 with earth leakage circuit breaker).

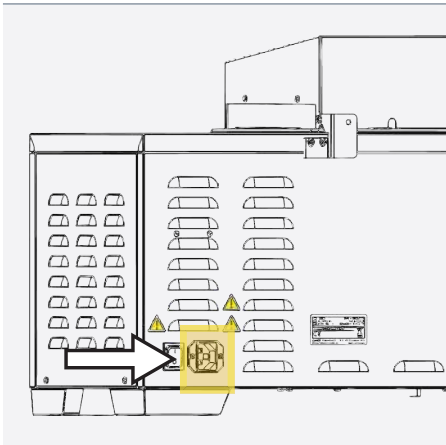

Route the power cable so that

- nobody can trip over it.
- it cannot come into contact with any hot parts.
- it is easily accessible at all times and the plug can be pulled out quickly in the event of a fault or emergency, for example.

### 5.3 Water specifications

Only water with the following specifications may be used in Memmert units:

- Demineralised water and distilled water (a variety of terms are used commercially for this) that is residue-free when it evaporates, according to regulation VDE 0510 and DIN 43530
- Conductivity of approx.  $> 1$ ;  $< 10 \mu\text{S}/\text{cm}$
- neutral pH value (between 5 and 7)
- Chlorine-free

The use of double-distilled water / ultrapure water / other highly purified water (a variety of terms are also commonly used) with an electrical conductance below about  $< 1 \mu\text{S}/\text{cm}$  must be avoided. The use of such water is not necessary and could damage the unit by corroding metallic components on and in the unit. Unsuitable water with an electrical conductance greater than  $10 \mu\text{S}/\text{cm}$  will damage the unit due to the residues that occur during evaporation and vaporisation, including the formation of limescale deposits.

### 5.4 Filling

Observe the following points before filling the waterbath:

- The waterbath may not be operated while empty.
- Check that the drain valve is closed before filling.
- Observe the minimum fill level of the waterbath.
- Observe the maximum fill level when filling and loading the waterbath, which must not be exceeded.

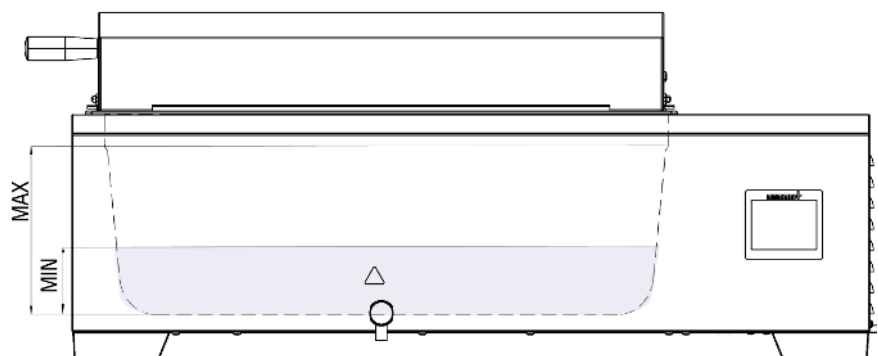

Product size	Maximum fill level	Minimum fill level
6	114 mm	40 mm

Product size	Maximum fill level	Minimum fill level
11	164 mm	40 mm
15	114 mm	40 mm
24	164 mm	40 mm
35	114 mm	40 mm
50	164 mm	40 mm

## 5.5 Switching on Unit

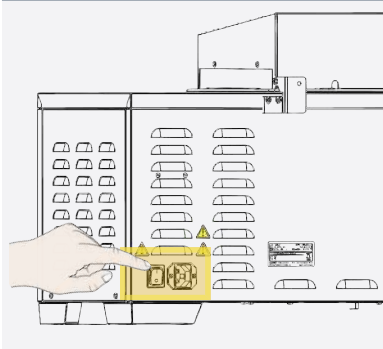

Press the main switch on the back of the unit.

## 6. Operation and Control

### ⚠ WARNING



#### High temperatures

Higher temperatures can result in considerable hazards for users and third parties.

- The information on all thermally relevant parameters contained in the data sheets for the materials to be heated must be taken into account in an appropriate manner.

### NOTICE



#### Operating the unit

The unit may only be operated as described in the operating manual. Failure to observe the operating manual can result in considerable hazards for users and third parties.



When the waterbath is put into operation for the first time, odours may be present for a short period.

### 6.1 Home Screen and Settings

#### Home screen



CustomView initially appears after switching the unit on.

To access the home screen, touch any point on the touch display.

- Select the **Set** symbol to adjust the set temperature.
- Select the symbol to set the timer.
- Select the symbol to set the alarm temperature.
  - Touch the symbol for other unit settings.

#### Settings

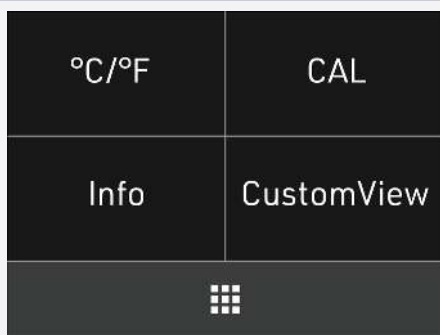

Other settings are possible under the **Settings** menu item.

- Set the desired temperature unit as °C or °F
- Set 2-point calibration
- Unit information overview
- CustomView setting
  - Press to return to the home screen

## 6.2 CustomView



1. Under the **Settings** menu item, select CustomView to set up the individual display.
2. Selecting the set temperature, timer time or alarm temperature will activate or deactivate the respective element.



3. Select the set temperature, timer time and alarm temperature.
  - ⇒ The selected element will be greyed out when deactivated.
  - ✓ confirms the selection
  - ✗ changes will not be accepted

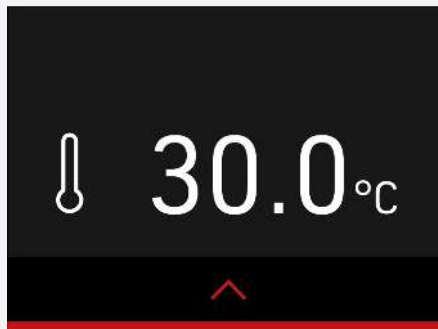

4. Confirm your selection.
5. Return to the home screen.
  - ⇒ The personalised CustomView will appear after 30 seconds.

## 6.3 Unit Information

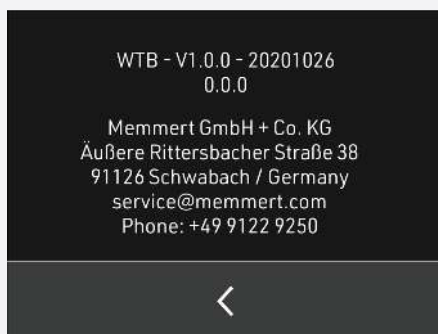

Go to **INFO** under the **Settings** menu item to view product information for the waterbath.

- Software version
- Serial number
- Contact details of the manufacturer

## 6.4 Values and Unit

### Setting the temperature and time

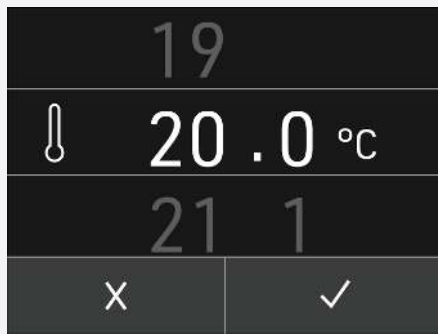

Set the individual values by scrolling vertically on the touch display.

- Enter the temperature for the set value in °C / °F
- Enter the alarm temperature in °C / °F
- Set time for the timer in minutes/hours

### Set the temperature display unit

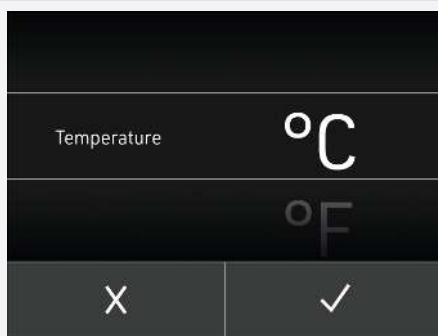

The unit for the temperature display is set under **Settings**.

## 6.5 Emptying

### ⚠ WARNING



#### Hot drain valve

When draining the tempering agent, there is a risk of burning and scalding.

- Open the drain valve by turning it 3 to 4 times to the maximum drain speed for the tempering agent. Be careful not to unscrew the drain valve completely.
- Do not discharge hot or boiling water through the drain valve.
- Use heat-resistant / waterproof protective gloves to turn the drain valve on/off.

Observe the following points before emptying the waterbath:

- Allow tempering medium to cool down before draining.
- Drain valve can overheat during operation, please observe safety instructions.
- Open drain valve slowly to prevent water from leaking out uncontrolled.

When emptying the waterbath, let the tempering medium drain either directly into a suitable and adequately sized container or push a suitable tube onto the drain valve (drain valve diameter: 12 mm), and hook it into a container.

## 6.6 Calibration

### 2-point Temperature Calibration

The units are temperature calibrated and adjusted at the factory. In case readjustment should be necessary later on, the unit can be calibrated for the customer using two calibration temperatures of your choice:

- **Cal1**: Temperature calibration at low temperature



■ **Cal2:** Temperature calibration at high temperature

To guarantee perfect control, we recommend calibrating the unit once a year.

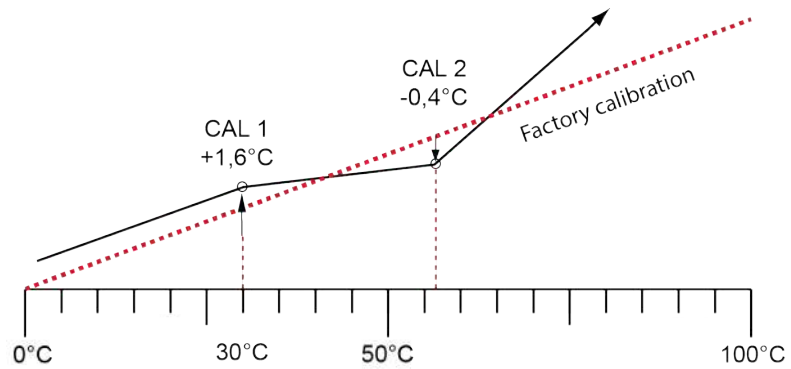

Calibration procedure

In the following example, the temperature calibration is performed for the example temperature of 30 °C:

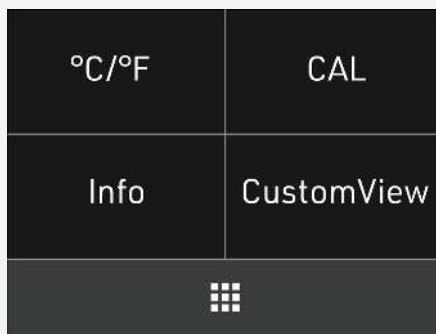

1. In the **Settings** menu under unit settings, select **CAL** to perform the 2-point calibration.



2. Select **CAL1 Temp** to set the compensation temperature **CAL1**.

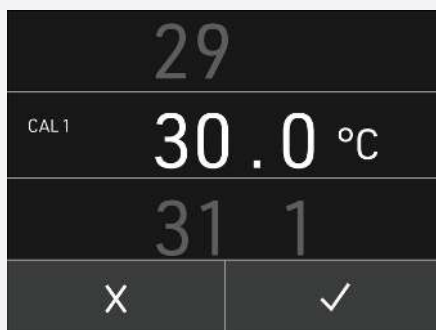

3. Scroll vertically to set the compensation temperature **CAL1** to 30 °C.

4. Confirm your selection.



5. Scroll vertically to set the compensation correction value **DEV 1** to 0.0 K.
6. Confirm your selection.

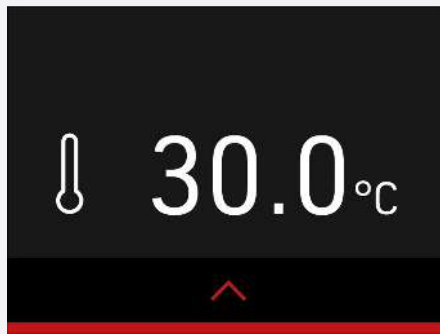

7. Set the unit **set temperature** to 30 °C.
8. Allow the unit to maintain this set temperature for approx. 1 h.

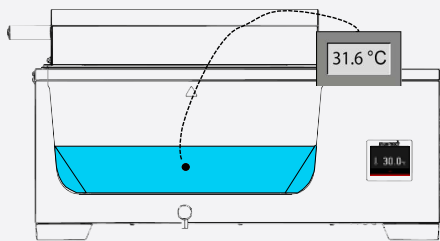

9. Position the sensor of a normally calibrated reference instrument centrally in the tray.  
⇒ The reference instrument displays for example 31.6 °C.

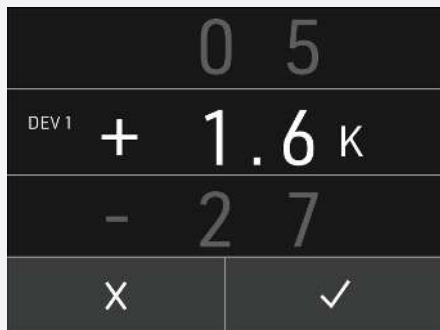

10. In the calibration settings, set the compensation correction value for **CAL1** to +1.6 K (measured actual value minus setpoint = correction value).
11. Confirm your selection.

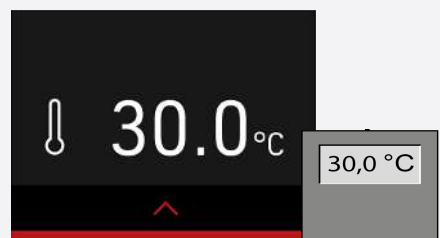

12. Verify by repeating the measurement with the set temperature.

## 7. Malfunctions, Warning and Error Messages

### DANGER



#### Risk of electric shock from unauthorised troubleshooting

Errors requiring intervention inside the unit may only be rectified by qualified electricians.

- Follow the measures listed in the event of a malfunction.
- Contact Memmert International After Sales.

Do not try to rectify appliance errors yourself; instead you should contact Memmert International After Sales or an authorised customer service point.

In case of enquiries, please always state the model and appliance number on the nameplate (see ▶3.6 Nameplate).

#### See also

Nameplate ▶ 12]



### 7.1 Warning Message of the Monitoring Function



#### 7.1.1 Temperature Monitoring

Description	Cause	Action
Temperature alarm is displayed 	Actual temperature has exceeded the set alarm temperature	<ul style="list-style-type: none"> <li>■ Unit must cool down until the actual temperature falls below the set alarm temperature.</li> <li>■ Increase alarm temperature if necessary</li> </ul>
Thermal fuse has triggered 	Appliance reports a defect	<ul style="list-style-type: none"> <li>■ If the error persists, contact: <a href="mailto:service@memmert.com">service@memmert.com</a></li> </ul>

Description	Cause	Action
Temperature sensor error 	Temperature sensor error	<ul style="list-style-type: none"> <li>Restart appliance</li> <li>If the error persists, contact: <a href="mailto:service@memmert.com">service@memmert.com</a></li> </ul>

## 7.2 Malfunctions, Operating Problems and Unit Errors

Error description	Cause of errors	Rectifying errors
Displays are dark 	External power supply was interrupted.  Miniature fuse, appliance fuse or power module faulty.	<ul style="list-style-type: none"> <li>Check the power supply</li> <li>If the error persists, contact: <a href="mailto:service@memmert.com">service@memmert.com</a></li> <li>If the error persists, contact: <a href="mailto:service@memmert.com">service@memmert.com</a></li> </ul>
	Software error	<ul style="list-style-type: none"> <li>Restart appliance</li> <li>If the error persists, contact: <a href="mailto:service@memmert.com">service@memmert.com</a></li> </ul>
	Memory access error	<ul style="list-style-type: none"> <li>Restart appliance</li> <li>If the error persists, contact: <a href="mailto:service@memmert.com">service@memmert.com</a></li> </ul>

Error description	Cause of errors	Rectifying errors
	CRC error (internal memory error)	<ul style="list-style-type: none"> <li>■ Restart appliance</li> <li>■ If the error persists, contact: <b>service@memmert.com</b></li> </ul>
	Shaking device blocking protection	<ul style="list-style-type: none"> <li>■ Switch off appliance</li> <li>■ Check shaking device for loads that may have fallen out or become stuck</li> <li>■ Remove the shaking device and reinsert it</li> <li>■ Restart appliance</li> <li>■ If the error persists, contact: <b>service@memmert.com</b></li> </ul>
	Water level too low	<ul style="list-style-type: none"> <li>■ Switch off appliance</li> <li>■ Adjust the water level</li> <li>■ Restart appliance</li> <li>■ If the error persists, contact: <b>service@memmert.com</b></li> </ul>

### 7.2.1 Power Failure

In case of a power failure, the unit operates as follows:

#### In manual mode

After the power supply has been restored, operation is continued with the parameters set. The time and duration of the power failure are documented in the log memory.

#### In timer or programme mode

In case of an interruption of the power supply of less than 60 minutes, the current programme is continued from the point at which it was interrupted. For longer interruptions of the power supply, all appliance functions are switched off.

After the power supply has been restored, the timer always starts again.

## 8. Maintenance and Servicing

### DANGER



#### Live parts

When covers are removed, live parts are exposed and contact with these parts may result in electric shock. Electric shock can have serious health consequences including death.

- Only authorised persons may carry out electrical installation work.
- Before starting work, disconnect the unit from the power supply.
- Ensure that the unit is fully de-energised.
- Secure the unit to prevent it from being switched on again.

### DANGER



#### Danger due to electric shock

Penetration of liquid into the unit can cause electric shocks and short circuits.

- Opening the electronics box is prohibited.
- Protect the unit from splashing water.
- Switch off the unit and disconnect the mains plug before cleaning and maintenance work.
- The unit must not be wet cleaned and disinfected. Allow the unit to dry completely before putting it back into operation.

### WARNING



#### Risk of burns

During maintenance and servicing, you could burn yourself on the unit if it is still hot. Only clean the unit when it is cold.

- Allow the unit to cool down to room temperature before cleaning.

### CAUTION



#### Danger of cuts due to sharp edges

Touching sharp edges on the unit may result in cuts.

- Wear protective gloves during all work.
- Be careful when handling sheet metal parts.

### 8.1 Cleaning

#### Interior and metal surfaces

Regular cleaning of the easy-to-clean bath prevents build up of material residues that could impair the appearance and functionality of the stainless steel chamber over time.

The metal surfaces of the waterbath can be cleaned with normal stainless steel cleaning agents. Make sure that no rusty objects come into contact with the interior or with the stainless steel housing. Rust deposits can lead to an infection of the stainless steel. If rust spots appear on the surface of the interior due to impurities, the affected area must be immediately cleaned and polished.

#### Plastic parts

Do not clean plastic parts of the waterbath with caustic or solvent-based cleaning agents.

## Glass surfaces

Glass surfaces can be cleaned with a commercially available glass cleaner.

## 8.2 Decontamination

### ⚠ CAUTION



#### Irritation of the skin and eyes

Skin and eye contact with decontaminants may cause irritation of the hands and eyes or allergic reactions and chemical burns.

- Wear chemical-resistant gloves during decontamination.
- For correct application, follow the instructions for use on the respective container of the decontamination agent.



Memmert units can become contaminated by loading infectious substances or by environmental influences at the place of installation. All parts of the affected unit must be decontaminated both before sending to our service department and before disposing of the unit.



For decontamination, we recommend commercially available alcohol-based decontaminants, i.e. isopropanol and/or ethanol (total alcohol concentration less than or equal to 70%).

If you have any questions about using a decontamination agent for decontaminating Memmert units, please contact our service department.

After cleaning and decontamination, ventilate the installation site and allow the unit to dry completely.

## 8.3 Regular Maintenance

Once a year, grease the moving parts of the doors (hinges and lock) with thin silicone grease and check that the hinge screws are not loose.

To guarantee perfect control, we recommend calibrating the unit once a year (see ▶ 6.6 Calibration).

#### See also

📄 Calibration [▶ 24]

## 8.4 Repairs and Service

Repairs and service work may only be carried out by specialist Memmert personnel and qualified service providers.

### NOTICE



Repairs and service work are described in a separate service manual.

## 9. Storage and Disposal

### 9.1 Storage

The appliance may only be stored and transported under the following conditions:

- in a dry enclosed, dust-free room
- disconnected from the power supply



Empty waterbath before storing.

### 9.2 Disposal

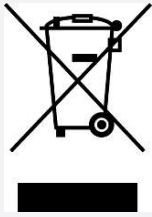

This product is subject to Directive 2012/19/EC on Waste Electrical and Electronic Equipment (WEEE) of the European Parliament and EU Council of Ministers. This unit was placed on the market after 13 August 2005 in countries which have already integrated this Directive into their national laws. It must not be disposed of as normal household waste. For disposal, please contact your dealer or the manufacturer. Any units that are infected, infectious or contaminated with materials hazardous to health are excluded from return. Please also observe all other regulations applicable in this context.









WTB Waterbath

Operating manual  
D49019 Effective 02/2024  
English

