



Dissolution Guide

Our broad range of dissolution testers



ERWEKA

Our Dissolution Program USP 1-7

ERWEKA offers dissolution testers for every single harmonized USP/EP/JP dissolution method – starting from USP 1 up to USP 7.



USP methods 1, 2, 5 and 6

We offer a broad range of dissolution testers - from manual testing with the DT 126/128 Light up to the high-volume tester DT 9510 Series.

USP methods	4
Test station positions.....	6
Low-head, high-head & cleaning position	7
DT 126/128 / 1212 Light.....	8
DT 950 Series.....	10
DT 9510 Series	12
DT 950 & 9510 Accessory Kit.....	14



Dissolution Systems

Our semi-automated dissolution systems are available as Offline, Online and On-/Offline Systems for UV-Vis and HPLC analytic.

Levels of Automation.....	16
Digital Dissolution Offline System	18
Dissolution Online System UV-Vis.....	20
Dissolution On-/Offline System HPLC.....	22
Dissolution On-/Offline System UV-Vis...24	



Pumps

Every dissolution system needs a pump – we offer several options suited to different needs.

Pumps for dissolution systems	25
-------------------------------------	----



Fully automated Dissolution System RoboDis II+

The productivity booster for fully automated, 24/7 non-stop dissolution testing with up to 40 batches.

RoboDis II+.....	26
------------------	----



Disso.NET 4 Software

Our advanced dissolution software solution Disso.NET 4 controls all our dissolution systems.

Disso.NET 4.....	30
------------------	----



Media Preparation

We offer the perfect companions to your dissolution tester for fast media preparation and filling of vessels.

MediPrep 820 series.....32

World exclusive



Chewing Gum Tester DRT

Our dissolution tester for testing of in vitro release of substances into surrounding liquid medium.

DRT.....34



USP methods 3/7

The RRT 10 BioDis for automatic dissolution testing of different extended and sustained release dosage forms.

RRT 10 BioDis35



USP 4

USP method 4 is supported by our Flow-Through Cell DFZ II, available as stand-alone or as a system.

USP 4 Flow-Through Cell DFZ II36
 Cell design.....38
 USP 4 Stand-alone System.....40
 USP 4 Open/Closed Offline System.....42
 Disso.NET USP 443
 LMT 243



Dissolution Options

ERWEKA offers a broad range of options for all of its dissolution testers and systems.

General Options44
 Vessels & Mini Vessels45
 Dissolution Accessories46
 Consumables50
 Mechanical Calibration.....50
 Manual Sampling.....52
 Automated Sampling.....52
 DT 950 Options53
 Dissolution System Options.....54

USP methods overview

USP method 1 – Basket



Application

- Immediate / Extended and delayed release forms
- Tablets
- Capsules
- Beads
- Floating dosage forms
- Agitation method: Rotating Stirrer

Advantages

- Lots of experience (oldest method, more than 200 monographs in USP)
- No sinker necessary
- pH change possible

USP method 2 – Paddle



Application

- Tablets
- Capsules
- Beads
- Immediate / extended and delayed release forms
- Agitation method: Rotating Stirrer

Advantages

- Lots of experience
- Easy to use and robust
- pH change possible

USP method 3 – Reciprocating Cylinder



Application

- Low solubility drugs
- Tablets / Capsules
- Implants
- Granulates & Powders
- Suppositories
- Stents
- Cremes / Dialysis
- Agitation method: Fluid Movement

Advantages

- Easy pH change
- Hydrodynamic can be influenced by varying dip and rate

USP method 4 – Flow-Through Cell



Application

- Low solubility drugs
- Tablets / Capsules
- Implants
- Granulates & Powders
- Suppositories
- Stents
- Cremes / Dialysis
- Agitation method: Fluid Movement

Advantages

- Laminar flow possible
- Easy media change
- pH profile possible
- 2 system setups:
 - open system (permanent fresh media)
 - closed system (long-term tests over many days)

USP method 5 – Paddle over Disk



Application

- Transdermal patches
- Floating dosage forms
- Ointments
- Emulsions
- Agitation method:
Rotating Stirrer

Advantages

- Standard equipment
(USP 2 - paddle can be
used)

USP method 6 – Rotating Cylinder

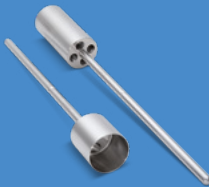

Application

- Transdermal patches
- Agitation method:
Rotating Stirrer

Advantages

- Standard equipment can
be used
- Variable volumes
- Big patches useable

USP method 7 – Reciprocating Holder



Application

- Transdermal patches
- Extended release dosage
forms
- pH profiles
- Agitation method:
Reciprocation

Advantages

- Small volumes possible
- Holder can be varied
- Easy pH change

Different holder types:

- Acrylic Rod:
Extended release tablets
- Angled Disk:
Transdermal system
- Fluoropolymer cylinder:
Transdermal system
- Spring holder:
Extended release tablets
- Reciprocating holder:
Transdermal system

Test station positions

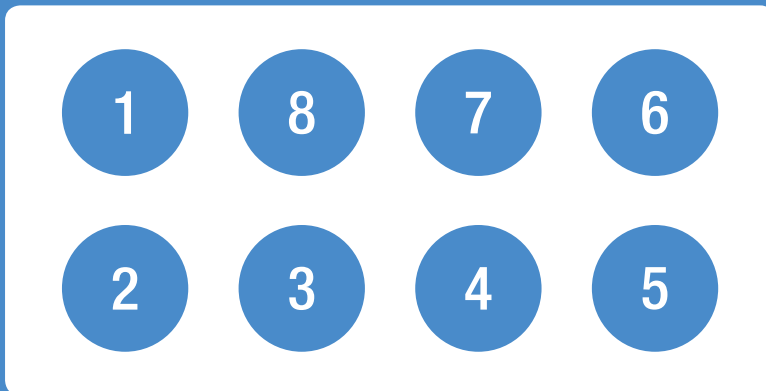

Schematic view of ERWEKA test stations

ERWEKA's dissolution tester can be equipped with 6 or 8 (12 or 14) test stations. Even though all of the testers are offered with a different number of stations, they differ from product line to product line.

The dissolution testers of the DT 950 series always come with inlets for 8 vessels, which are covered with blinds, if a DT with 6 test stations is ordered.

The dissolution tester DT 126 light comes with a fixed number of 6 test stations, its bigger sibling, the DT 128 light comes with 8.

Dissolution testers with less than 8 stations can be upgraded by ERWEKA service.

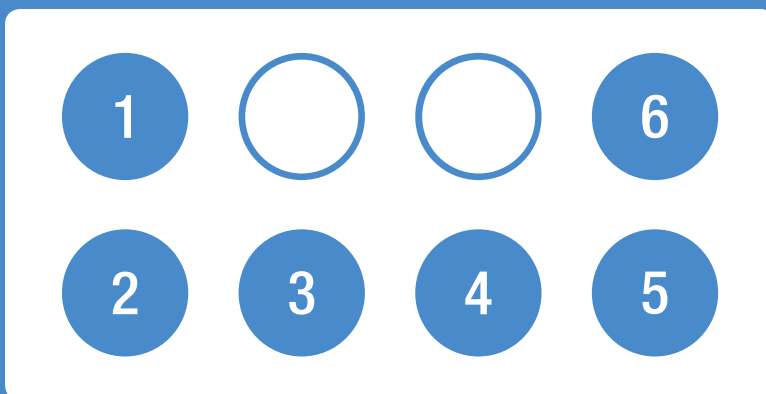

Vessel configuration example
DT 956

Positions one through six are usually used for the samples. Position seven and eight are used for reference and blank samples, which are for example required for UV-Vis measurement.

Low-head, high-head und cleaning position

ERWEKA's dissolution tester DT 950 offer two different operating modes which differ by the position of the head, and a third position for cleaning.



Low-head operating mode (LH)

The low-head mode on DT 950 is the standard mode and usually comes in conjunction with a system configuration with automated sampling station (ASS-9). Benefits are the closed vessels and therefore low evaporation.

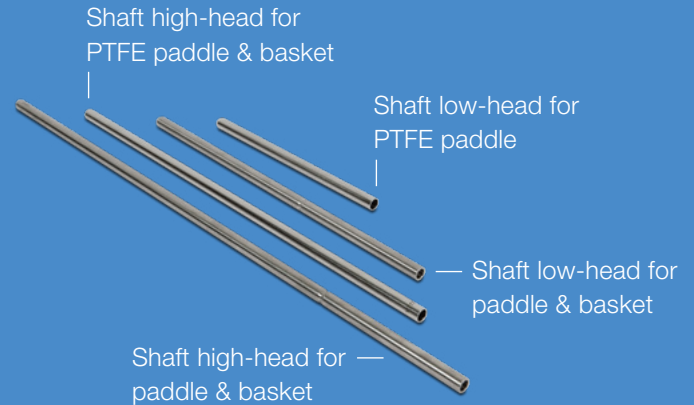

High-head operating mode (HH)

The high-head mode is best used for manual testing and manual sampling on DT 950. To reduce evaporation, vessels are covered with a cover. Manual sampling is easier in high-head mode. Longer shafts have to be selected on purchasing for high-head mode. In addition, the high-head mode is the only mode of the DT light devices with a fixed head position.



Cleaning position

The cleaning position is the highest position of the dissolution testers' head. It makes cleaning effortless and easy on DT 950.

DT light Series

The ERWEKA DT light Series delivers the proven ERWEKA quality in a comprehensive package for a budget for simple dissolution testing with USP method 1, 5 and 6. The DTs are equipped with 6, 8 or 12 test stations and a fixed drive head (high-head), allowing easy access to each 1000 ml vessel.

The shafts can be replaced easily and the unique water bath of moulded PET is equipped with the time-proven ERWEKA water outlet for easy cleaning. The external flow through heater reduces the influence of external vibrations and ensures a constant temperature. Every accessory that comes into contact with the dissolution sample is installed in Germany. Therefore our DT light Series has the ERWEKA made in Germany quality.

All these features make sure that the ERWEKA DT light Series is the perfect entry-level device for the world of dissolution testing.

Highlights

- 100 % USP/EP/JP compliant
- Compact design saving lab space
- High-head mode for easy access to the vessels
- Universal shafts with attachments for Method 1, 2 (paddles included), 5 and 6 available
- Easy cleaning of the water bath and the set-up area
- External flow through heater reduces influence of external vibrations and ensures constant temperature
- Simple control using symbol keypad with LED display for waterbath temperature, RPM (speed per minute) and runtime
- Manual sampling using height adjustable holder for USP sampling points

100%

100%
USP/EP/JP
compliant



Manual
testing

LED display and
symbol keypad
for easy control



Conical evaporation vessel
covers are included

Art. No.	Dissolution Tester DT 126 / 128 Light incl. vessels, paddles, shafts
19996	DT 126 Light Dissolution Tester, USP method 2 paddle with 6 test stations
20412	DT 128 Light Dissolution Tester, USP method 2 paddle with 8 test stations
25025	DT 1212 Light Dissolution Tester, USP method 2 paddle with 12 test stations

DT 126 light

Specifications

- High-head with 6 test stations
- Dimensions (width / depth / height): 510 mm / 450 mm / 660 mm
- Weight: 30 kg

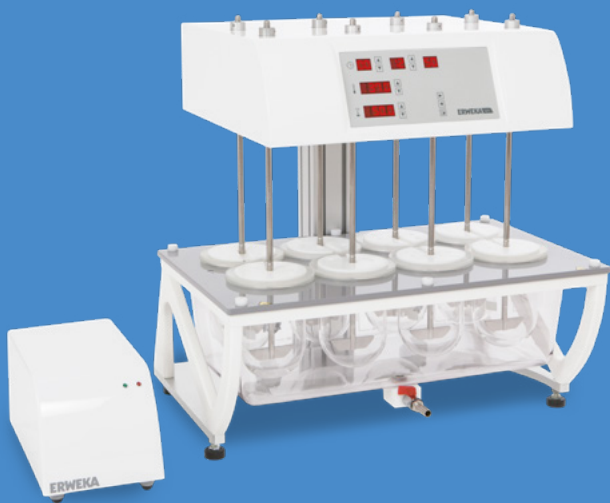
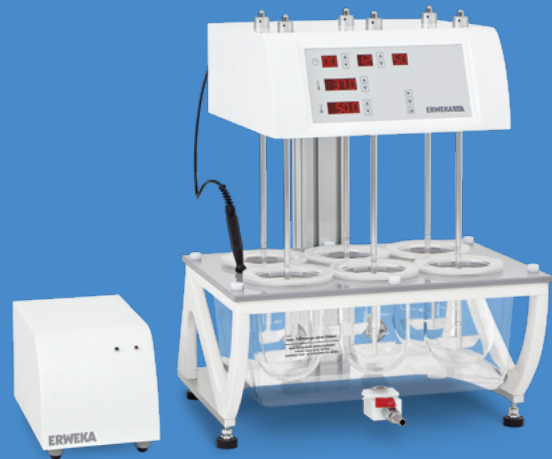

DT 128 light

Specifications

- High-head with 8 test stations
- Dimensions (width / depth / height): 642 mm / 482 mm / 680 mm
- Weight: 38 kg

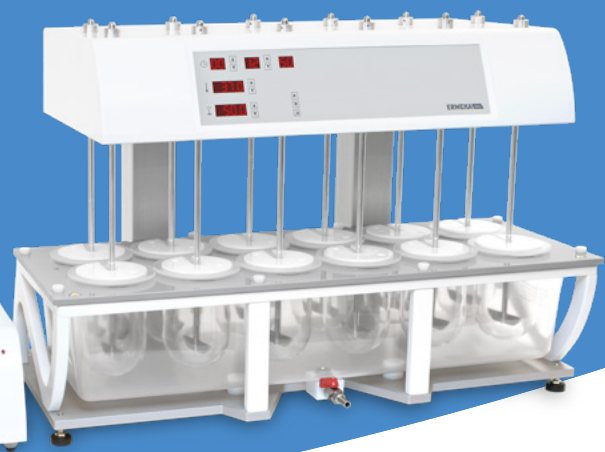

DT 1212 light For high volume testing

Specifications

- High-head with 12 test stations
- Dimensions (width / depth / height): 932 mm / 444 mm / 656 mm
- Weight: 60 kg



The DT 950 Series

Digital today. For the challenges of the future.

The ERWEKA DT 950 Series is our first digital dissolution tester on the market, equipped with the most advanced technology for the requirements of today and the challenges of tomorrow.

With state-of-the-art embedded PC technology, the DT 950 is the first of its kind. The 7" touch display with a modern user interface focuses the user on the most important task the DT 950 has to fulfill - 100% USP/EP/JP compliant dissolution testing, without distractions and errors. For this purpose, we have designed the ERWEKA TestAssist, an intelligent helper that guides the user step by step through the configuration of the dissolution test, provides assistance and makes sure that only compliant parameters can be entered.

In addition to the modern user interface, the DT 950 is completely future-proof. With our „Upgrade your DT“ programme, it can be upgraded at a later date - e.g. from 6 up to 8 test stations, with an automatic tablet drop or an automatic sampling station, if the DT 950 is to be upgraded to a dissolution system at a later date. A switch from low-head to high-head mode is also easily possible at all times. Thanks to the advanced embedded system, software functions for the touch display can also be added later.

With all these innovations, however, we have not lost sight of the most important thing: The DT 950 Series is 100% USP/EP compliant.



USP methods
1, 2, 5 and 6

100%

100%
USP/EP/JP
compliant



Intuitive
touch interface



Upgradeable
at any time

Art. No.	Dissolution Tester DT 950 Series
27380	DT 956 (LH/HH) 1000 ml Dissolution Tester with 6 test stations
27542	DT 957 (LH/HH) 1000 ml Dissolution Tester with 7 test stations
27543	DT 958 (LH/HH) 1000 ml Dissolution Tester with 8 test stations
27646	DT 956 (LH/HH) 2000 ml Dissolution Tester with 6 test stations
27647	DT 957 (LH/HH) 2000 ml Dissolution Tester with 7 test stations
27648	DT 958 (LH/HH) 2000 ml Dissolution Tester with 8 test stations

The image shows an ERWEKA DT 950 dissolution tester. It is a white, multi-station machine with a digital display on top. The display shows 'System Status' with 'DT 950' and 'ERWEKA' logos. Below the display, there are several glass dissolution vessels (beakers) arranged in a row. Three callout boxes are overlaid on the image, each with a white background and a dark header. The first callout box is at the top right, the second is in the middle right, and the third is at the bottom right. Each callout box contains text and a bulleted list of features. The background is a solid blue color.

Digital embedded PC technology

The digital embedded PC technology offers all advantages and unlimited possibilities of modern software programming making the DT 950 more future-proof than ever before. In the first step, this means simple network printing and a modern user interface. In the future, the DT 950 Series will be expanded with additional functions and can thus constantly adapt to the user's requirements and future industry 4.0 developments.

Modern user interface with TestAssist

The modern user interface of the DT 950 focuses the user on the most important function of the DT 950 - dissolution testing.

- TestAssist, the intelligent guide for dissolution testing
- DirectHelp, help directly on the screen with the tap of a button
- Multilanguage operation in English, French, Spanish, Russian, Chinese and German.

Upgrade your DT

The newly developed hardware of the DT 950 Series enables step by step upgradeability from a manual dissolution tester to a semi-automatic On-line-, Offline- or On-/Offline system.

- Upgrade up to 8 test stations
- Optional, automatic tablet drop
- ASS-9 automatic sampling station



AirLift System - easy to use and safe!

The AirLift system makes raising and lowering of the high volume digital dissolution head as easy and safe as ever!

The operator simply pulls the safety lever at the front of the DT 9510, and then pushes a button for either upward or downward movement. Whenever either of the two is released, movement stops immediately, making the AirLift system and handling of the high volume dissolution head as safe as possible. AirLift is an option of the DT 9510 Series dissolution tester and can also be upgraded after purchase.

Modern user interface with TestAssist

The modern user interface of the DT 9510 Series focuses the user on the most important function of the DT 9510 - dissolution testing.

- TestAssist, the intelligent guide for dissolution testing
- DirectHelp, help directly on the screen with the tap of a button
- Multilanguage operation in English, French, Spanish, Russian, Chinese and German. If you are interested in more language, contact us.



Upgrade your DT

The newly developed hardware of the DT 9510 Series enables step by step upgradeability from a manual dissolution tester to a semi-automatic Online-, Offline- or On-/Offline system.

- Upgrade up to 14 test stations
- Optional, automatic tablet drop
- ASS-18 automatic sampling station with 14 temperature sensors

The DT 9510 Series

High volume digital dissolution testing.

The ERWEKA DT 9510 Series is the bigger sibling of the digital DT 950 Series dissolution tester.

Controlled by the same embedded PC, every component of the DT 9510 is focused on reliable, high volume digital dissolution testing: The test stations (up to 14) are driven by a single, powerful motor and the big waterbath holds the temperature stable due to the thermal inertia of water. This ensures that parallel testing of two batches of samples can be done at precisely the same conditions, making comparison between the two as reliable as possible and 100% USP/EP compliant.

With the new optional AirLift system, the dissolution head of the DT 9510 can be simply raised and lowered by the press of two buttons. Furthermore, DT 9510 Series has the same features as its smaller sibling - digital dissolution testing is done with the help of the latest version of the testing assistant TestAssist and samples can be automatically dropped into the vessel by the optional automatic tablet drop.



USP methods
1, 2, 5 and 6



100%
USP/EP/JP
compliant



Intuitive
touch interface



Upgradeable
at any time

Art. No.	Dissolution Tester DT 9510 Series
28312	DT 9512 (LH/HH) 1000 ml Dissolution Tester
28389	DT 9513 (LH/HH) 1000 ml Dissolution Tester
28390	DT 9514 (LH/HH) 1000 ml Dissolution Tester

DT 950 & 9510

Accessory Kit

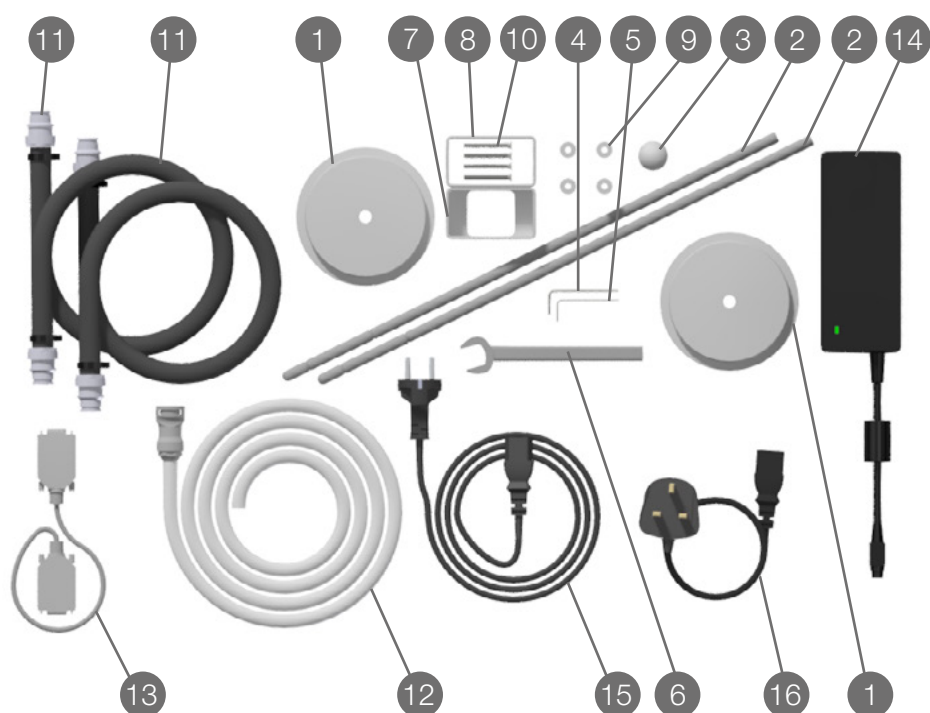





Nr.	Name	Purpose
1	Centring disc	Adjustment of the vessels
2	Measuring shaft	Adjustment of the vessels
3	POM-Plastic ball, d=25mm	Adjustment for height of paddles and baskets
4	Hexagon-wrench, SW2	Assembly shaft
5	Hexagon-wrench, SW2,5	Assembly power supply holder
6	Open-end wrench size 17	Leveling of the device
7	Power adapter holder part 1	Attachment power supply to DT
8	Power adapter holder part 2	Attachment power supply to DT
9	Power adapter holder cylinder	Attachment power supply to DT
10	Power adapter holder screws	Attachment power supply to DT
11	Heating tubes	Water supply between DT and heater
12	Drain hose with quick coupling	Emptying the water bath
13	RS-232-Connection cable	Communication between DT and heater
14	Power adapter 120W-24V-5A	Power supply
15	Power cord type F	Power supply European plug
16	Power cord type G	Power supply British plug



Levels of Automation

ERWEKA offers several products for different types of automation levels. The semi-automated Dissolution Offline System for automation of three steps of the dissolution process or a semi-automated Dissolution Online System are perfect entry-level systems into the world of 100% USP/EP/JP,

automated testing. Our Dissolution On-/Offline System with UV-Vis or HPLC analysis automates five steps of the dissolution process. In addition with a MediPrep the media preparation can also be automated.

Dissolution Steps	 Setup 1.	 Media preparation and filling 2.	 Tablet drop, stirring of baskets or paddles 3.	 Automated Sampling & Filtration 4.
Levels of Automation		MediPrep 820	Manual Testing	
		MediPrep 820	Semi automated Dissolution Offline System	
		MediPrep 820	Semi automated Dissolution Online System with UV-Vis	
		MediPrep 820	Semi automated Dissolution On-/Offline System with UV-Vis	
		MediPrep 820	Semi automated Dissolution On-/Offline System with HPLC	
Fully automated Dissolution System				

For fully automated 24/7 testing and 100%-reproducibility of all tests, we offer the RoboDis II+ - a real productivity booster with fully automated dissolution testing of up to 40 batches including setup, media preparation and cleaning automation.

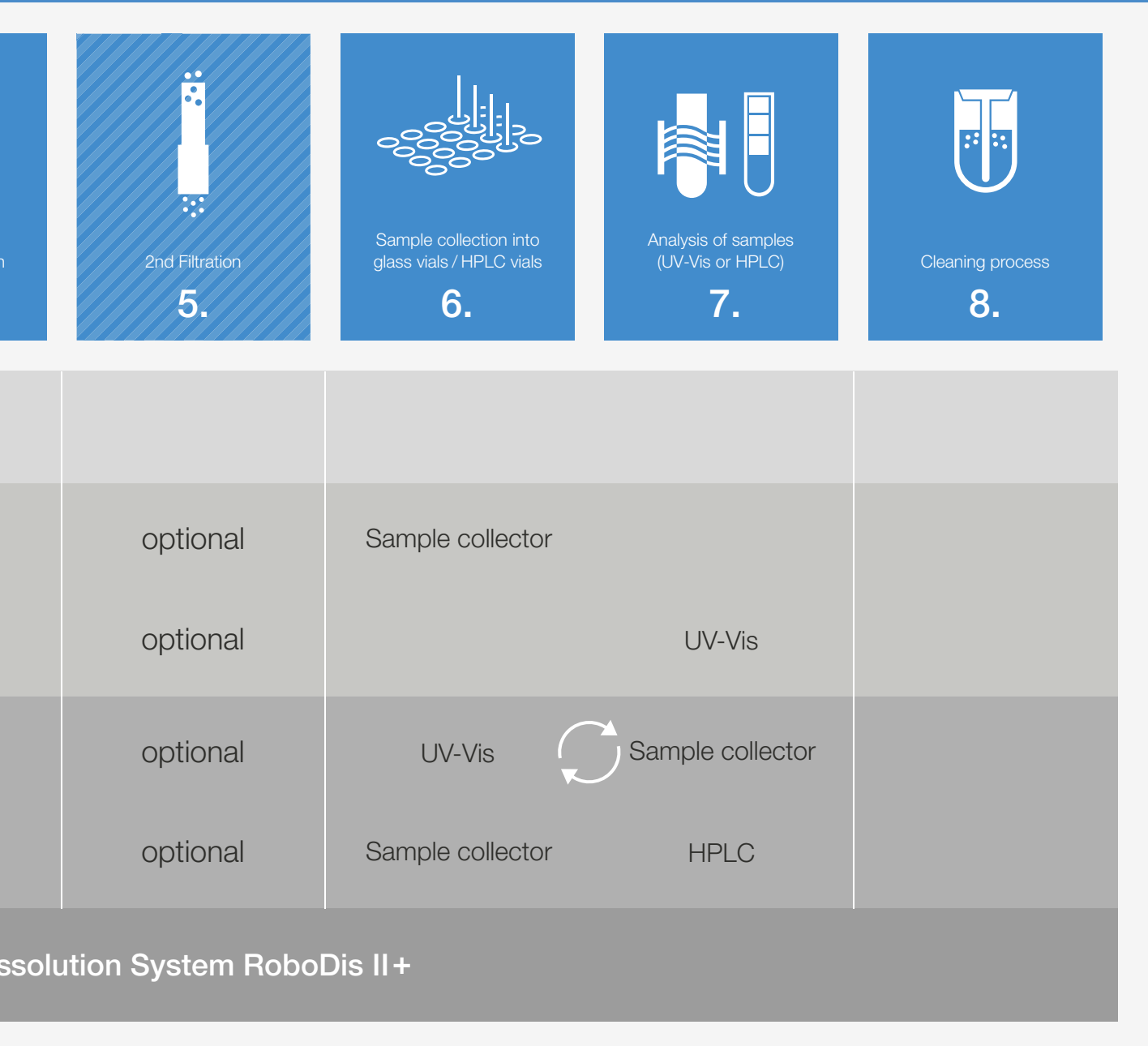

Dissolution System RoboDis II+

The Digital Offline System

Digital today. For the challenges of the future.

The new digital Offline System for DT 950 & 9510 Series is the next step to utilize the power of digital dissolution testing. It expands the advanced technology used in the DT 950 & 9510 Series to the first step of dissolution automation: fully automated sampling and storing in vials for separate analysis.



With the updated TestAssist, the user can easily configure and start dissolution tests with automated sampling on our 7" touch display. The design principles first introduced with the DT 950 have been applied to offline testing, making it as fast, easy and error-proof as never before. The user is guided through the dissolution test with automated sampling in few simple steps, enabling 100% USP/EP/JP compliant dissolution testing without distraction and errors and ensuring constantly compliant parameters.

But there is more - with the new user management, conform handling of the complete digital offline system is only a button-tap away. Users can be easily configured with individual rights, making it easy to restrict functions only to authorized users - for example Administrators, Operators and Service technicians.

The new digital Offline System is our most advanced stand-alone dissolution system, offering an easy-to-use first step into dissolution automation.



USP methods
1, 2, 5 and 6

100%

100%
USP/EP/JP
compliant



Full stand-alone
control of connec-
ted hardware



Any DT 950/9510 can
be upgraded to a
digital offline system

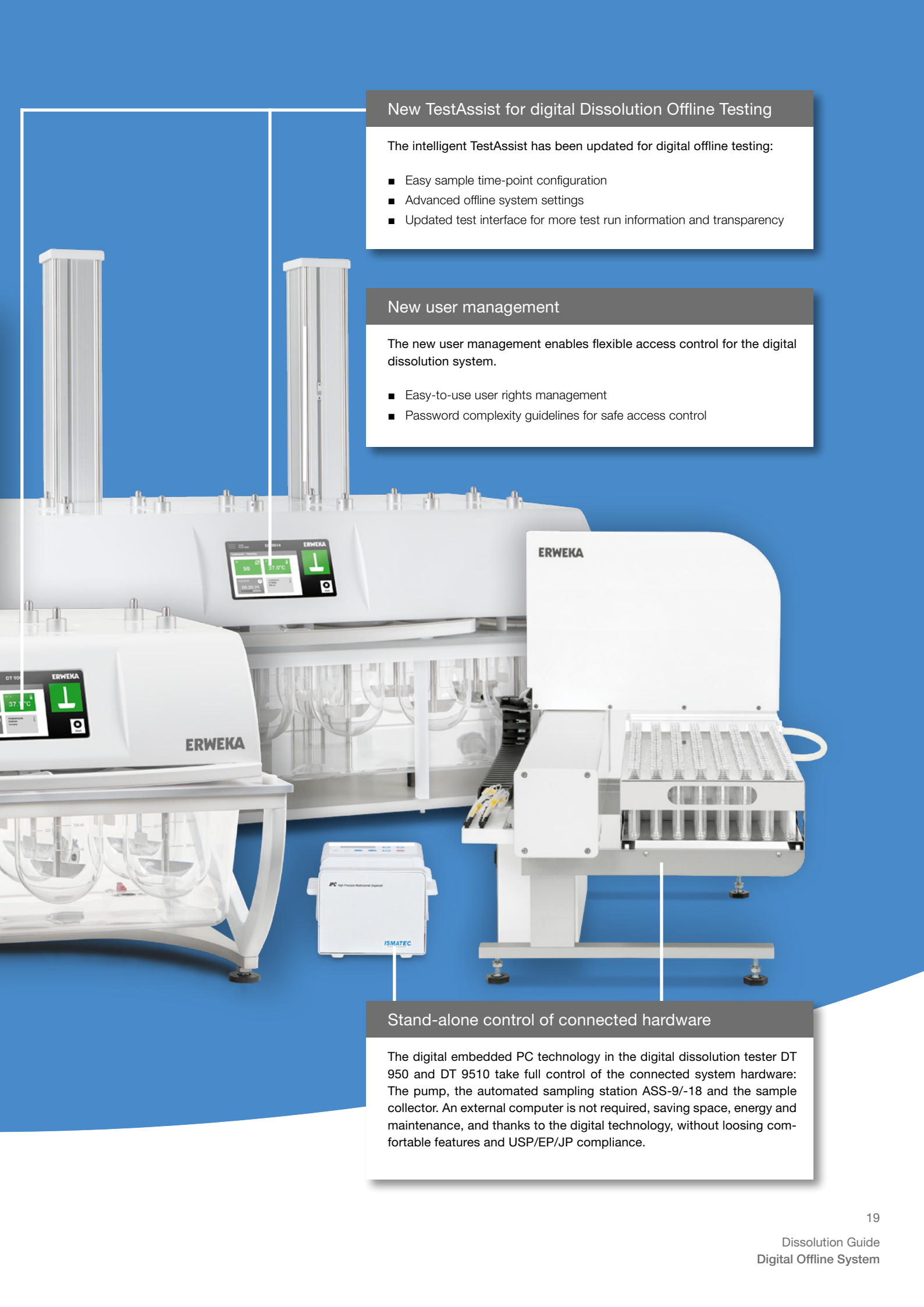

Art. No.	Dissolution Offline System
25371	Standard Offline Dissolution System with IPC 8 for DT 826, FRL 654
25370	Standard Offline Dissolution System with IPC 8 for DT 828, FRL 854
25376	Standard Offline Dissolution System, IPC 16 f. DT 1612, FRL 654-2
25378	Standard Offline Dissolution System, IPC 16 f. DT 1614, FRL 754-2

The image shows a collection of ERWEKA digital dissolution testing equipment. On the left is the DT 950, a white machine with a digital display showing '37.0°C' and a green arrow. In the center is the DT 9510, a larger white machine with a digital display showing '50', '37.0°C', and '08:20:23'. To the right is the ASS-9/-18 automated sampling station, a white machine with a tray of test tubes. In the foreground is the ISMATEC JPC High Precision Multichannel Dispenser, a small white box. The background is a solid blue color.

New TestAssist for digital Dissolution Offline Testing

The intelligent TestAssist has been updated for digital offline testing:

- Easy sample time-point configuration
- Advanced offline system settings
- Updated test interface for more test run information and transparency

New user management

The new user management enables flexible access control for the digital dissolution system.

- Easy-to-use user rights management
- Password complexity guidelines for safe access control

Stand-alone control of connected hardware

The digital embedded PC technology in the digital dissolution tester DT 950 and DT 9510 take full control of the connected system hardware: The pump, the automated sampling station ASS-9/-18 and the sample collector. An external computer is not required, saving space, energy and maintenance, and thanks to the digital technology, without losing comfortable features and USP/EP/JP compliance.

The highlights of the Dissolution Online System UV-VIS

The ERWEKA Dissolution Online Systems are the perfect, semi-automatic solution for dissolution testing with integrated UV-Vis online analysis. The DT 950 with automatic sampling station ASS-9 transports freshly taken samples via a pump directly to the UV-Vis analysis. The samples are analyzed directly and the data is evaluated and saved using our advanced Disso.NET software.

With the help of the Analytik Jena Specord 200/210 UV-Vis photometer that we recommend, cycles in the 185 nm to 1200 nm range can be tested and evaluated with high efficiency. In connection with the maintenance-free pump PVP 820, the customer can trust on highest reliability in dissolution testing.

100%

100% USP/EP compliant half-automatic dissolution testing



USP Method 1, 2, 5 and 6



Ultra-fast Analytik Jena UV-Vis Spectrophotometer



Completely software controlled by Disso.NET

Art. No.	Dissolution Online System
28777	UV-Vis Online System w. Analytik Jena Specord 200, IPC 8 for DT 95x
27961	UV-Vis Online System w. Shimadzu 1900i, IPC 8, Disso.NET 4.x Software for DT 95x
28778	UV-Vis Online System w. Analytik Jena Specord 200, PVP 820 for DT 95x
27963	UV-Vis Online System with Shimadzu 1900i, PVP 820, Disso.NET 4.x for DT 95x



Dissolution Tester DT 950

The ERWEKA DT 950 is the perfect dissolution tester for the ERWEKA DT online system. The DT 950 ensures absolutely reliable test results that the user can rely on. 100% USP/EP compliant, in the usual robust ERWEKA quality and with integrated automatic sampling station ASS-9 and automatic tablet drop.

High-precision pumping with the PVP 820

With the maintenance-free PVP 820 piston pump with high pressure, the samples are transported precisely from the dissolution tester to the Analytik Jena Specord 200/210 Photometer.

Complete control with Disso.NET

The Windows software Disso.NET completely controls the entire dissolution system, manages methods with tests and generates the associated reports. The software tracks all changes that are made using the integrated 21 CFR part 11 compliant audit trail. Thanks to the full integration of the Analytik Jena Specord 200/210, the UV-Vis evaluation takes place directly in the Disso.NET - so the user has all the data of the dissolution test in one place. The USP / EP photometer qualification can also be done on request.

Analytik Jena Specord 200/210 UV-Vis Photometer

The Analytik Jena Specord 200/210 is an ultra-fast UV-Vis photometer that is effective in tracking chemical reactions in a short time. It is completely USP/EP compliant and enables cycles in a 185 nm to 1200 nm range. It is completely integrated in the Disso.NET from hardware control up to data evaluation and can be qualified on request.

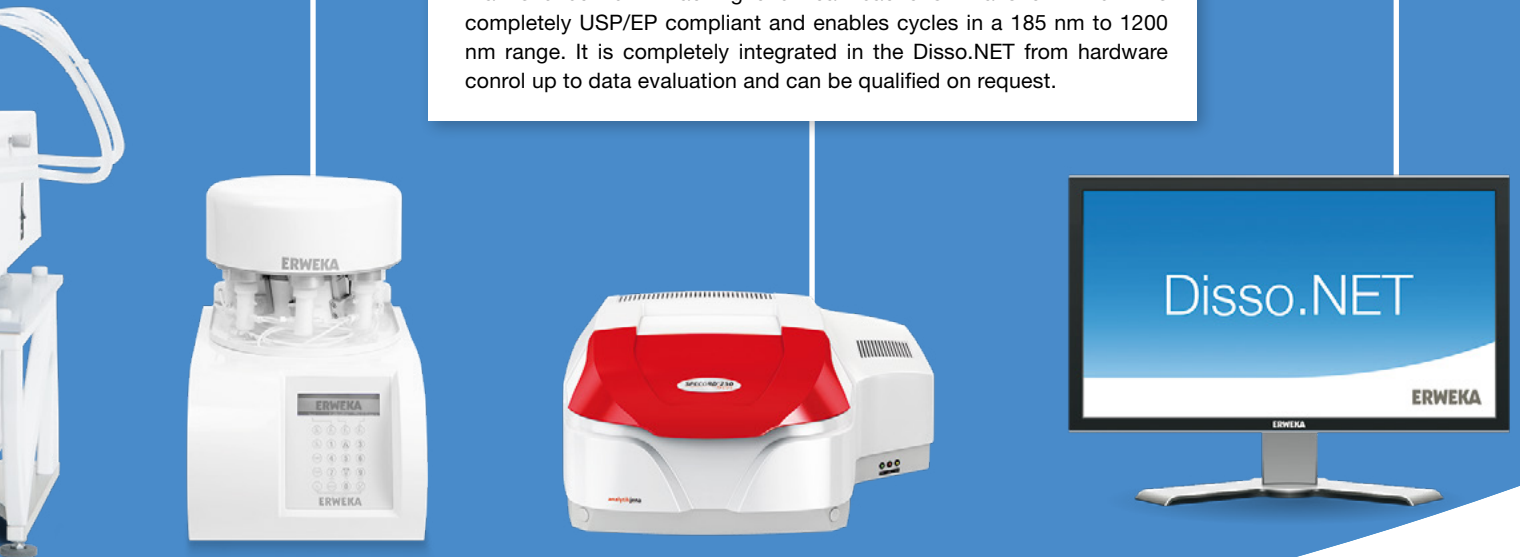

The highlights of the Dissolution On-/Offline System with HPLC

The ERWEKA Dissolution HPLC On-/Offline System is the semi-automatic solution for 100% USP/EP/JP compliant dissolution testing with HPLC online analysis. Up to 5 of 8 dissolution steps can be automated by combining one of our highly qualified DT 950 series dissolution testers with devices for CTC sampling and online HPLC chromatography. The entire system with all components is controlled by our easy-to-use Disso.NET software.

For filtrations up to 0.22 µm, our automated filter changer AFC 825 can be used in combination with our maintenance-free PVP pump. In addition, to a precise and simple control of the entire system, Disso.NET offers an accurate recording of the whole test process, from the automatic recording of the sampling time up to the recording of the temperature and rotation speed in each vessel (= Documentation of all system operations, audit trail).

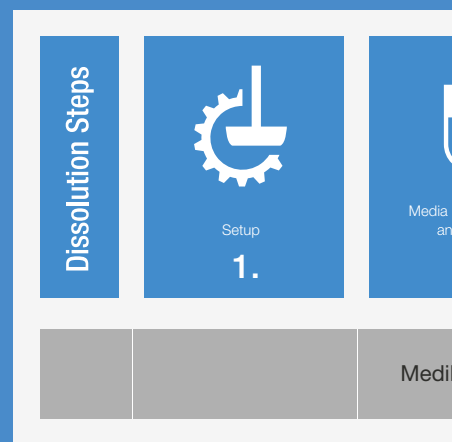

100% USP/EP/JP compliant



21 CFR Part 11 conform in conjunction with Disso.NET software



PAL RSI sample collector and sample storage for HPLC analysis



5 of 8 dissolution steps are automated



Dissolution Tester DT 950

Our digital dissolution tester of the DT 950 series is 100% compliant to USP methods 1, 2, 5 and 6 and can be operated in high-head as well as low-head mode.

PVP 820 Pump

The test medium is transported with high precision and pressure via eight channels to the automated filter changer AFC 825 by the practically maintenance-free piston pump. In conjunction with the AFC 825, it enables a filtration with up to 0.22 µm flat membrane filters.

Double filtration with AFC 825

In case of a HPLC analysis it is recommended to perform a double filtration, to avoid contamination or damage of the HPLC column due to particles, thus improving the accuracy of the HPLC analysis. The high-precision, practically maintenance-free PVP pump in combination with the automated membran filter changer are particularly suitable for this purpose. APC 825 for 6 or 8 stations.

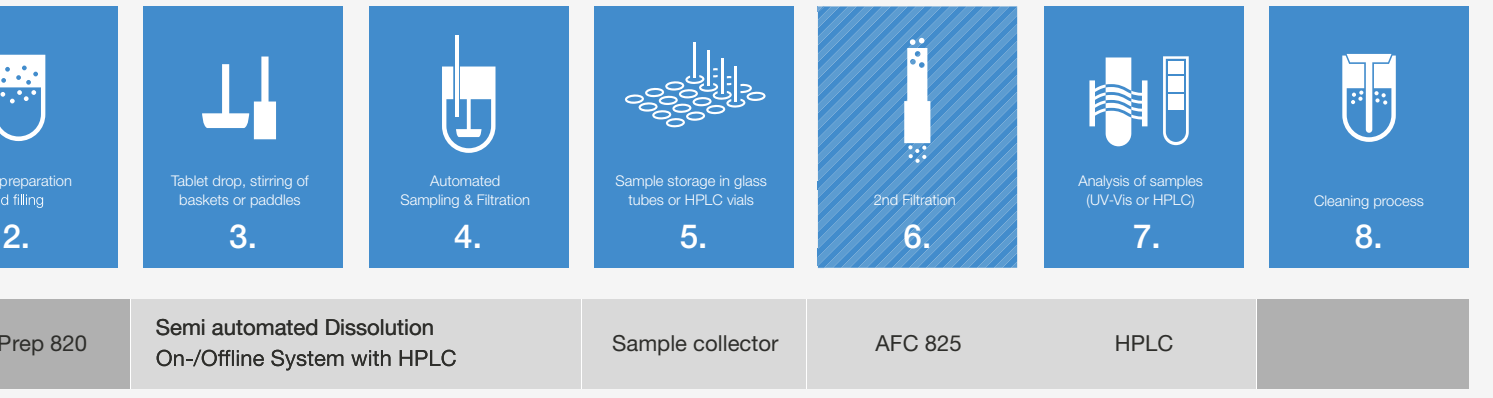

HPLC sample collection & analysis

With the HPLC sampler the samples can be collected (and cooled) and injected automatically in the HPLC system. Analysis and evaluation are done by the HPLC analysis device and the associated analysis software (different providers: Agilent, Shimadzu, Waters etc.).



Art. No. On-/Offline System HPLC
 27969 HPLC On-/Offline Dissolution System w. PVP 620 pump, RSI sampler for DT 95x

HPLC analytic equipment not included in system configuration! Different manufacturers supported.

NOTE

ERWEKA Systems

Dissolution On-/Offline System UV-Vis

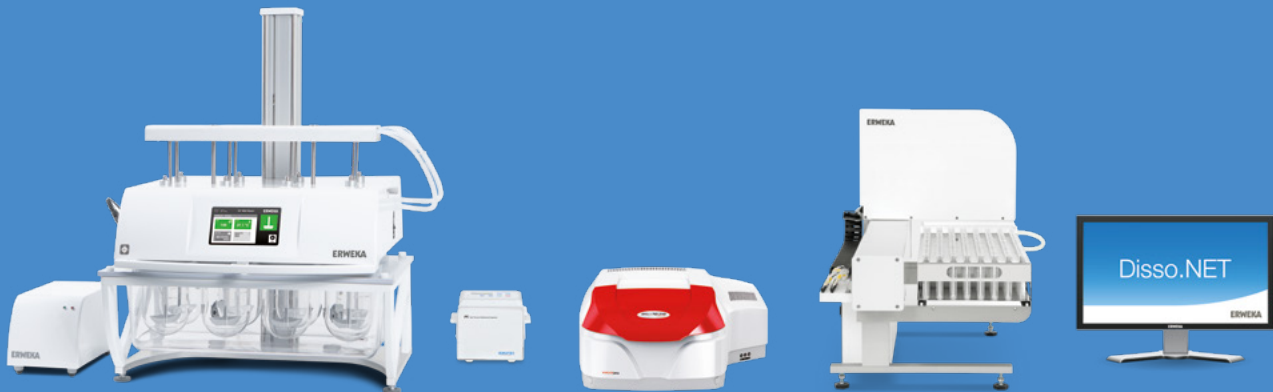

The ERWEKA Dissolution UV-Vis On-/Offline System is the ideal system configuration for spectrophotometers. With the connected PC, the On-/Offline System can be conveniently controlled via our advanced Disso.NET software. Moreover, the software offers full control over all components and storage of all test results.

After analysis has been completed, the samples are comfortably stored by our very own sample collector FRL 654/754/854 for later HPLC analysis or as reference standard.

Highlights

100%

100%
USP/EP/JP
compliant

Disso.NET

Controlled
by Disso.
NET



USP methods
1, 2, 5 and 6



Advanced
UV-Vis
analysis



Sample
collector and
storage

Art. No.	Dissolution On-/Offline System UV-Vis
28779	UV-Vis On-/Offline Dissolution System w. Analytic Jena Specord 200, IPC 8 for DT 95x
27965	UV-Vis On-/Offline Dissolution System Shimadzu 1900i, IPC-8, Disso.NET for DT 95x
28780	UV-Vis On-/Offline Dissolution System w. Analytic Jena Specord 200, PVP 820 for DT 95x
27967	UV-Vis On-/Offline Dissolution System Shimadzu 1900i, PVP 820 for DT 95x

The ERWEKA Dissolution Systems are also available with the high volume dissolution tester DT 9510.



Overview

Pumps for Dissolution Systems



	Peristaltic pump		ERWEKA piston pumps	
Pump	IPC 8 / 16	PVP 620 / 720 / 820	PVP 1220 / 1420	
Channels	8 or 16	6 or 8	12 or 14	
Valves	-	-	-	
Accuracy	25 ml +/- 5%	25 ml +/- 5%	25 ml +/- 5%	
Media replacement	Standard	Standard	Standard	
Double filtration (optional)	Only when first filtration with poroplast filters. No media replacement possible when double filtration.	No media replacement possible when double filtration	No media replacement possible when double filtration	
Required type of sample collector	FRL 624 / 724 / 824	FRL 624 / 724 / 824	FRL 624 -2 / 724-2 / 824-2	
System compatibility	DT Offline / DT Online DT On-/Offline	DT Offline / DT Online DT On-/Offline	DT Offline / DT Online DT On-/Offline	
Advantage	Basic pump possible with DT 950/9510, needs regular replacement of tubing	Filtration down to 0.22 µm for flat membrane filters, Best choice for fully automated dissolution systems	Filtration down to 0.22 µm for flat membrane filters, low maintenance even at high throughput, Best choice for dissolution systems	

Fully automated: RoboDis II+

The flexible specialist
for R&D

Many types of dosage forms

The RoboDis II+ can handle several types of dosage forms. No matter what you use - tablets, granulates or powders - the RoboDis II+ is the ideal, flexible and fully automated dissolution system for all your usage needs. It even handles Japanese Sinkers with a size of up to 34 mm with ease!

Versatile filtration

Filtration with the RoboDis II+ has no boundaries - inline poroplast filters, membrane filters down to 22 µm and even double filtration are supported.

pH Half Change and pH Full Change (USP methods A & B)

The fully automated pH change (both half and full possible) is supported by the RoboDis II+. Just configure your method using the powerful Disso.NET software and run your test – the RoboDis II+ will automatically take care of the rest.

Broad range of analytics available

RoboDis II+ supports a broad range of analytical devices. UV-Vis spectrophotography, chromatography using HPLC or even a combination of both – the RoboDis II+ handles and controls all of them.

6 reference standards

Mandatory in R&D: Flexible reference standards for quick testing of several formulations. Thanks to an integrated standard changer system, the RoboDis II+ handles them with ease.



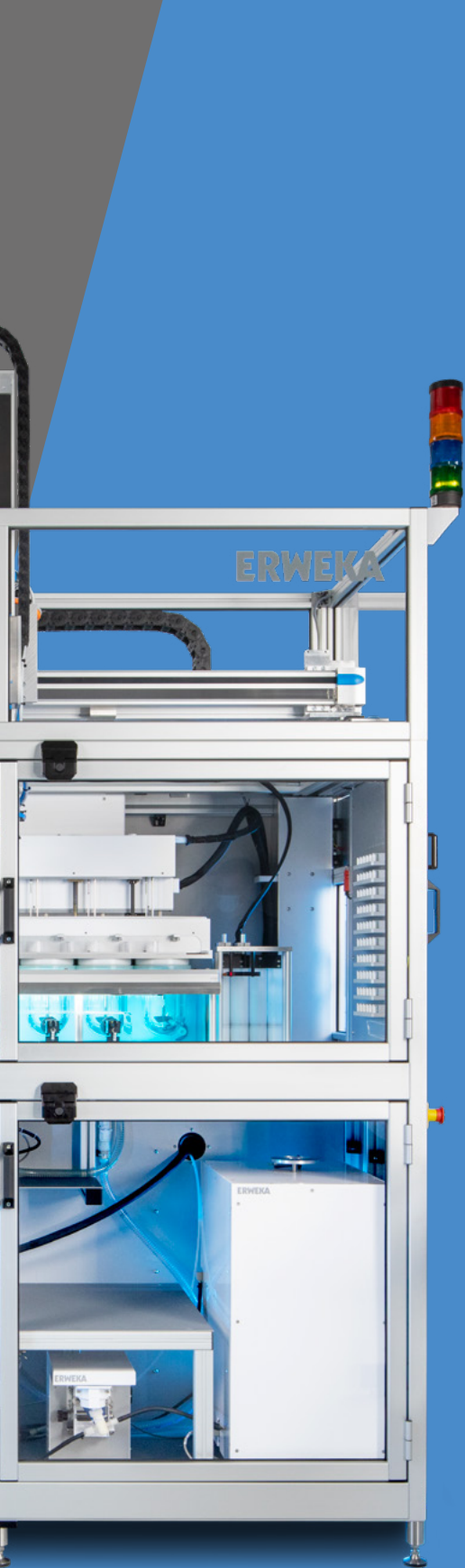

The Productivity Booster for Quality Control

Planned productivity with 10 or 40 batches

Productivity can be easily scheduled with the RoboDis II+. For example, the system can autonomously handle up to 40 batches during the weekend and then present all the results to the laboratory employee on the following workday for evaluation. With video recording and time-lapse function, a visual inspection of the completed test process is possible afterwards.

High volume – 40 batches

Testing, testing, testing - that is what the RoboDis II+ does best. The 40 batch option allows volumes that are usually only matched by a multitude of semi-automated systems, demanding a lot more laboratory space and staff than ERWEKA's RoboDis II+. Real productivity gain!

Parallel approach

The RoboDis II+ is following a parallel test approach: Tablet drops, sampling and emptying of the vessels are all done in parallel.

Robotic precision & integrated error control

Every dissolution step is fully automated and is completely tracked by the software itself (SST). This means, that all tasks performed by the RoboDis II+ during a test are identically repeated in the next test, thus removing the human error factor completely. The system offers highest reliability and allows the laboratory employees to concentrate on the analysis of the provided data.

Space-saving footprint

To match the RoboDis II+s productivity with semi-automated systems, at least three Dissolution Online Systems and operators are needed to perform 10 batches per day. Convince yourself!

The Productivity Booster









RoboDis II+

The fully automated dissolution system is already used in quality control and R&D by several multinational companies and has brought a huge increase in productivity. It fully automatically handles 10 or 40 batches of dissolution testing USP method 1 basket or method 2 paddle in a parallel approach, therefore enables very short sampling points of 5 minutes, depending on product and method. As all ERWEKA products, the RoboDis II+ works 100% conform to all harmonized pharmacopoeias in every aspect.

All steps of the dissolution process - media preparation, filling, setup of dissolution tester, testing, automated sampling, online analytics (UV-Vis or HPLC) and the whole cleaning process are performed automatically and without the need of user intervention. The whole system is controlled by the ERWEKA Disso.NET software, from the robot arm to media preparation and analytic devices.

Supported by several integrated System Suitability Tests (SST) and light sensor checks, this system runs absolutely precise and reliable, minimizing human error. It is human error proofed so to say.

Highlights

- 
100%
 100% USP/EP/JP compliant
- 
Controlled by Disso.NET
- 
USP methods 1 and 2
- 
System Suitability Tests (SST)
- 
10 or 40 batches in one test run
- 
Video monitoring
- 
Online UV-Vis or HPLC analysis
- 
pH half change or full change
- 
Vacuum degassing



10 or 40 Batch sample magazine for continuous testing 24/7.



Continuous verification of processes with controlling sensors.



24/7 testing with LED light bar and six ethernet cameras.



Simultaneous tablet insertion allows high accuracy of processes.



pH change in accordance with USP Method A (Half Change) and optional USP Method B (Full Change) possible.

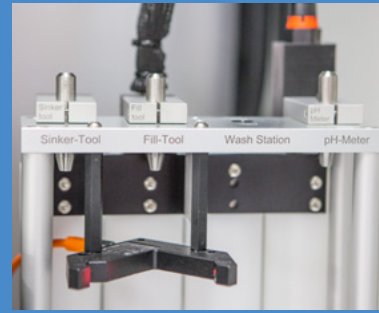

Different tools for different applications are available.

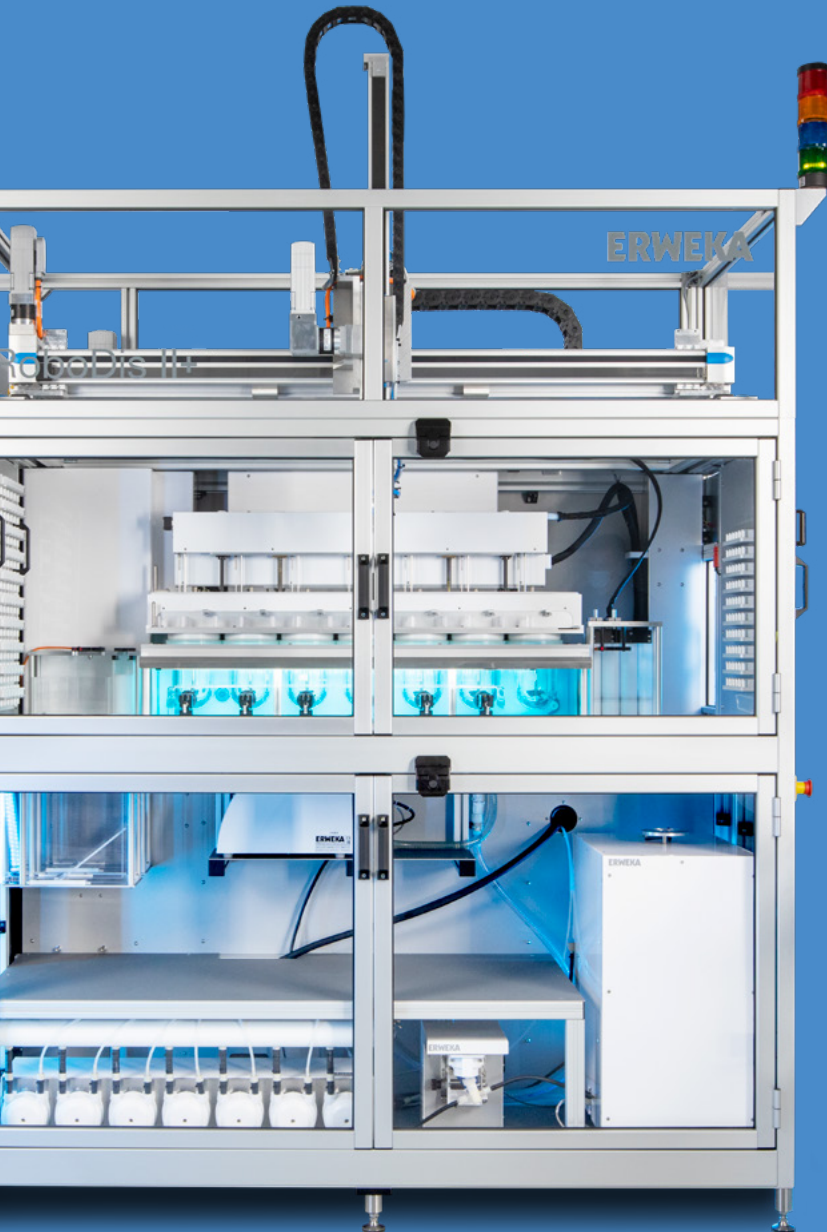

Automatic cleaning and result checks of the cleaning process (SST).

The new Disso.NET 4 dissolution software

The ERWEKA Disso.NET 4 is the perfect 21 CFR Part 11 compliant companion to all our Dissolution Systems, ranging from Dissolution Offline over Online to On-/Offline Systems up to the fully automated RoboDis II+ system.

The software helps you with standard dissolution jobs, easily handles qualification tasks and provides control over each single function and connected devices (e.g. dissolution tester with UV-Vis spectrophotometer). After finishing those tests, Disso.NET creates extensive reports with corporate logos for PDF-file export or exports your results in XLS or XML.

Our extensive Audit Trail according to latest 21 CFR part 11 thoroughly documents all changes done to the system (what, who, when and why) and can be easily searched and filtered by the Audit Trail Viewer.

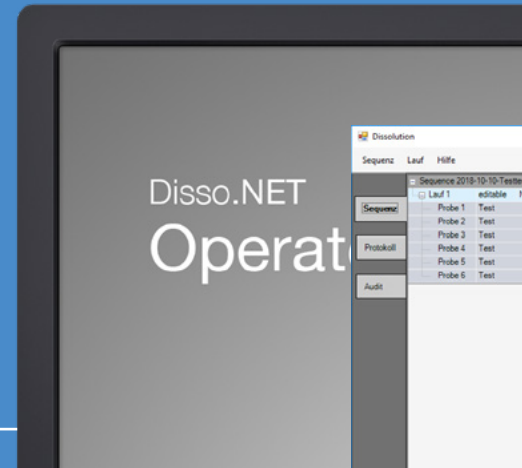

Supports Dissolution Systems, RoboDis II+

The Disso.NET 4 supports all ERWEKA Dissolution Systems and the fully automated RoboDis II+.

Full Audit Trail according to 21 CFR Part 11

The Audit Trail feature is implemented throughout the whole software, tracking each and every change (What, Who, When and Why). If data is changed by the user (e.g. when editing methods), the software requires a reason entered by the user. In combination with our easily search- and filterable audit trail viewer, changes to the system and its data can be easily traced back to its origin and originator. With Disso.NET 4, it is not possible to delete data from the system to maintain data integrity.

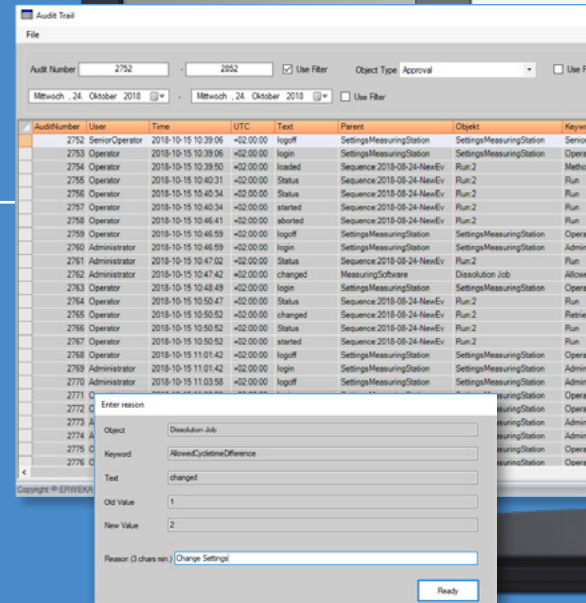

Automated prompt for reason of change

100% Full Audit Trail according to 21 CFR Part 11

Support for USP methods 1, 2, 5 and 6

MS SQL Database

User Management with Active Directory

Easy documentation with industry proven features

The documentation features of the Disso.NET 4 are vast: Easily generate reports about products, tests, audit trail, measurement conditions, UV-Vis and HPLC workflows and export data as PDF, XML and Excel format.

Report: Audit Print ERWEKA

11:29:39 ringStation ringStation T-SN_Labor
2442 DBAdmin 08.10.2018 11:29:39 +02:00:00 login SettingsMeasu SettingsMeasu DBAdmin ringStation ringStation Disso.NET_D T-SN_Labor

Report: Audit Print ERWEKA

Filters

Type	Column	Condition	Value
Prefilter	Parent		SettingsMeasuringStation
Prefilter	Time	GreaterThanOrEqualTo	01.10.2018
Prefilter	Time	LessThanOrEqualTo	24.10.2018

Audit

AuditNumber	User	Time	UTC	Text	Parent	Objekt	Keyword	OldValue	NewValue	Reason	MeasuringStation
2253	DBAdmin	08.10.2018 15:28:06	+02:00:00	login	SettingsMeasu ringStation	SettingsMeasu ringStation		DBAdmin			Disso.NET_D T-SN_Labor
2255	DBAdmin	08.10.2018 15:39:19	+02:00:00	login	SettingsMeasu ringStation	SettingsMeasu ringStation		DBAdmin			Disso.NET_D T-SN_Labor
2399	DBAdmin	08.10.2018 15:42:02	+02:00:00	created	SettingsMeasu ringStation	SettingsMeasu ringStation	Checksum			recalculate	Disso.NET_D T-SN_Labor
2436	SeniorOperato	09.10.2018 10:20:21	+02:00:00	login	SettingsMeasu ringStation	SettingsMeasu ringStation		SeniorOperato			Disso.NET_D T-SN_Labor
2437	DBAdmin	09.10.2018 10:28:56	+02:00:00	login	SettingsMeasu ringStation	SettingsMeasu ringStation		DBAdmin			Disso.NET_D T-SN_Labor
2438	DBAdmin	09.10.2018 10:30:40	+02:00:00	login	SettingsMeasu ringStation	SettingsMeasu ringStation		DBAdmin			Disso.NET_D T-SN_Labor
2439	DBAdmin	09.10.2018 10:38:10	+02:00:00	login	SettingsMeasu ringStation	SettingsMeasu ringStation		DBAdmin			Disso.NET_D T-SN_Labor
2440	DBAdmin	09.10.2018 10:49:46	+02:00:00	login	SettingsMeasu ringStation	SettingsMeasu ringStation		DBAdmin			Disso.NET_D T-SN_Labor
2441	DBAdmin	09.10.2018 11:29:39	+02:00:00	login	SettingsMeasu ringStation	SettingsMeasu ringStation		DBAdmin			Disso.NET_D T-SN_Labor

Instrument SN: Disso.NET_OT-SN_Labor
Disso.NET V 4.0.0

print date: 2018-10-24T14:19:46.3490529+02:00
printed by: Administrator

Page 1 / 6

Art. No. Disso.NET

25349 Disso.NET Dissolution Software Version 4.x Full audit trail

25343 Upgrade license Disso.NET from Version 2.x to Disso.NET 4.x

25344 Upgrade license Disso.NET from Version 3.x to Disso.NET 4

25350 Software module for Disso.NET 4.x UV-Vis Photometer Qualification

Advanced media preparation of 16 liters
in less than 25 minutes

MediPrep Series

The ideal companion for our dissolution systems

The MediPrep series offers quick and easy preparation of up to 16 liters dissolution media in less than 25 minutes. In a single pass, the media for dissolution tests can be precisely mixed, heated, de-gassed and gravimetrically filled into vessels. Foaming media like SDS (Sodium Dodecyl Sulfate) can also be used.

Gravimetrically controlled filling can be done at the integrated dosing port or with the optional remote filling hand directly into the vessels.

The MediPrep 820 provides one inlet for premixed media and one outlet for waste water. In comparison the MediPrep 1622 offers two additional inlets for media concentrates or premixed media. To prevent cross contamination, an automated cleaning procedure is integrated.



Up to 3x faster than manual media preparation*

The devices of the MediPrep family allow up to 3x faster media preparation in comparison to a manual approach. Even better - while MediPrep does all the media preparation on its own, the laboratory employee can focus on other more important tasks, thus increasing productivity.

100%

100 % USP/EP
compliant filling



GLP/GMP
compliant
documentation

SDS

Up to 14 | 1 %
SDS-containing
medium with
MediPrep 1622



Memory for 50 users
with three different
access levels



Memory for 100
methods

8 |
16 |

Available with 8
liter and 16 liter
tank

Art. No.	MediPrep Series
18605	MediPrep 820 (230 V) 8 liters with one inlet
27014	MediPrep 820 (115 V) 8 liters with one inlet
25813	MediPrep 1622 (230 V) 16 liters with two inlet
26943	MediPrep 1622 (115 V) 16 liters with two inlet

*compared to manual media preparation



Complete GLP / GMP documentation

The ERWEKA MediPrep logs all important information according to GLP/ GMP standards that arise during media preparation and can easily assign the data to a batch ID on the report.

Highly precise filling

Thanks to gravimetric filling, the MediPrep works with the highest precision that the user can always rely on.

Integrated cleaning procedure

Thanks to the integrated cleaning procedure, the MediPrep can automatically clean the built-in media container and all tubing. This leaves no residues and the user can easily prepare the next medium without wasting time.

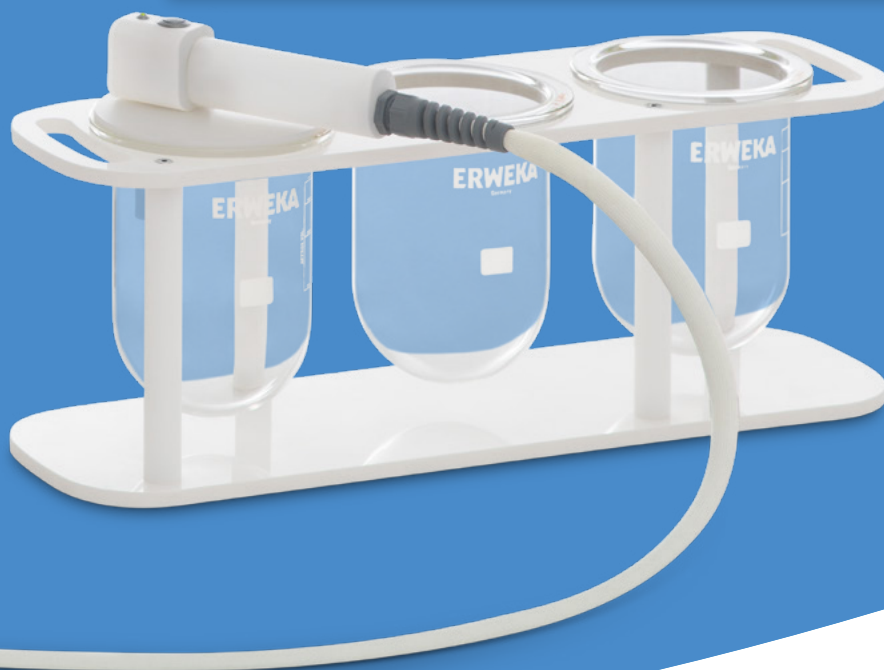

Chewing Gum Tester DRT



world exclusive

Highlights

100%

100%
USP/EP/JP
compliant



Movement by
pneumatic
cylinder

6x

Up to 6
test
stations



Mobile cart



Temperature
controlled
water bath



Easy
cleaning

Testing for in vitro release of substances from samples into surrounding liquid medium

The ERWEKA DRT is the perfect device for testing of in vitro releases of substances from chewing gums and other dosage forms, that have to be masticated, into the surrounding liquid medium. The vertical up and down strokes of the lower jaw in combination with a revolving movement of the upper jaw provide ideal mastication of the chewing gum and at the same time an agitation of the test medium.

For manual sampling, emptying and cleaning the lower jaw with the test cell can be lowered into a down position, so that the chewing process stops.

The test cell, the upper and lower jaw can then be easily removed. A water circulation system controls and regulates the water temperature in the test cell around the media.

The chewing gum test apparatus is used to masticate gums and then analyzes the speed at which various substances leave the gum (release). In addition, the device is very helpful for developing candy chewing gums, but it can also be used for unusual purposes such as testing of snuff bags.

Art. No.	Chewing Gum Tester DRT
18620	DRT 1 Chewing Gum Tester (1 test station), incl. manual
18621	DRT 2 Chewing Gum Tester (2 test stations), incl. manual
18622	DRT 3 chewing Gum Tester (3 test stations), incl. manual
18623	DRT 4 Chewing Gum Tester (4 test stations), incl. manual
18624	DRT 5 Chewing Gum Tester (5 test stations), incl. manual
18625	DRT 6 Chewing Gum Tester (6 test stations), incl. manual





Multiple media pH change dissolution testing for USP 3 and 7

RRT 10 BioDis

With the ERWEKA RRT 10, automatic dissolution testing of different extended and sustained release dosage forms has become easier than ever before. This unit is perfectly suited for simulating the pH changes within the human body. By placing different media in each row, the device reflects varying in vivo gastrointestinal conditions of the body. An automatic sample transport between the rows allows the reliable testing of the extended or sustained release from different dosage forms in various pH zones. The simple to program RRT 10 is the perfect unit for multiple media pH changes for IV/IVC testing and dissolution profiling of a variety of release dosage forms (e.g. tablets, coated tablets and oblongs).

Vessels are placed inside an acrylic water bath with an outlet valve for easy cleaning and the automatic cover system of the RRT 10 reduces media evaporation.

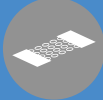
Highlights

- 
100% USP/EP/JP compliant
- 
3 configurations available
- 
Automated evaporation cover
- 
Different tools available

	USP 3	USP 7	USP 3 & USP 7
Height of stroke	100 mm	20 mm	100 mm & 20 mm (changable)
Vessel types	300 ml & 1000 ml for reciprocating cylinder	50 ml, 100 ml, 300 ml & 1000 ml for different types of tools	50 ml, 100 ml, 300 ml & 1000 ml for different types of tools
User changeable method	—	—	✓



Art. No.	RRT 10 BioDis
18532	BioDis dissolution tester RRT 10 USP method 3 with 8 rows
18533	BioDis dissolution tester RRT 10 USP method 7 with 8 rows
18534	BioDis dissolution tester RRT 10 USP method 3 & 7 user changeable, 8 rows

The highlights of the USP 4 Flow-Through Cell DFZ II

The ERWEKA flow-through cell tester DFZ II can be used for various applications thanks to its wide range of available cell types, e.g. for testing poorly soluble products or low-dose formulations with sustained release.

mentation of dissolution tests according to UPS method 4. The leaner cell bodies ensure an improved cell warming and can be heated individually. All USP 4 DFZ II systems can be easily controlled with the Disso.NET USP 4 dissolution software via a controller.

Innovations as the cell design with increased leak-tightness and the optimized tubing system with quick locks allow a fast preparation and imple-



Standardized cell head

The new cell head fits all offered cell bodies and thus enables a faster assembly of cells while offering lower purchasing costs. Through a quick lock in the cell head faster tube mounting is also possible.

Excellent leak-tightness

Due to reducing the number of seals to 3 pieces per cell and using flat seals with an increased sealing surface, the process safety can be heightened.

Optimized cell bodies and individual cell heating

The reduction of the cell body provides a better heating and faster preparation of cells. Each cell can be heated individually via a rotary switch.

Highlights

100%

100%
USP/EP/JP
compliant



Independent,
closed flow-th-
rough system



Variety of
different cells
available



Controlled by
Disso.NET
USP 4





Compact & corrosion-resistant housing

The small footprint with clear arrangement of cells in one line saves laboratory space and offers a perfect visual control of the cells at all times. In addition, the tube organizer on the back of the device prevents mixing up the cell tubes.



New improved Cell design

Quick lock system on universal cell head

Accompanying our flow-through systems, we offer a variety of different cells with a new improved design for different purposes - from the standard tablet cell to granulate & powder cells to cells for implants, suppositories and stents.

The new standardized cell head fits all offered cell bodies and facilitates along with the new standardized flat seals handling and assembly of the cells. The optimized cell bodies with decreased cell wall thickness guarantee an improved cell heating.

Thanks to this new cell concept, the cells can be mounted easier to the new flow-through tester DFZ II and thus enable a faster preparation and performance of dissolution tests.

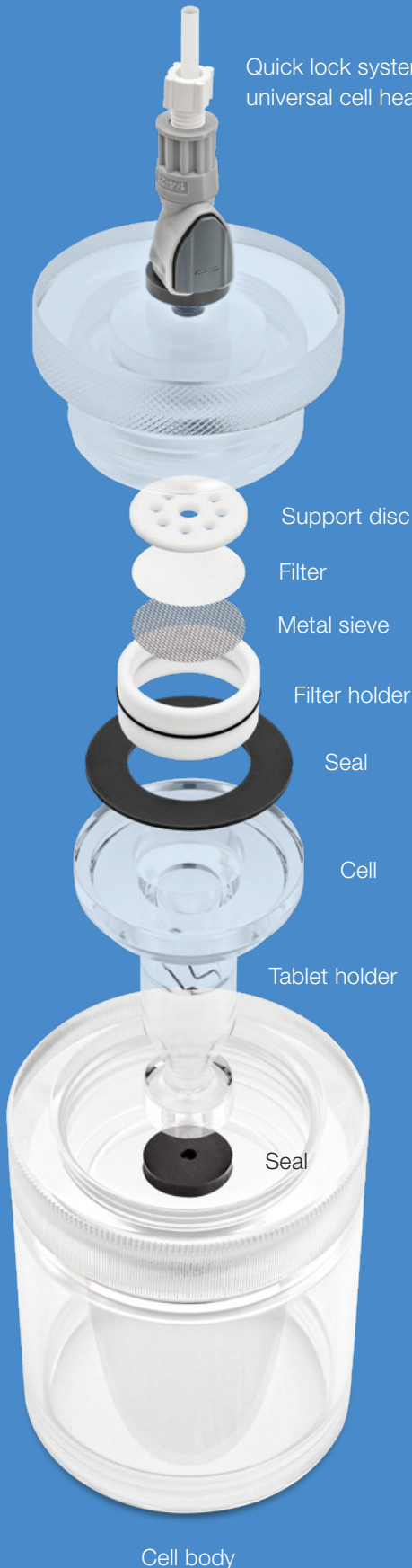

New quick lock system on the cell head allows instant tube removing.



Special temperature calibration head.

Highlights



Variety of different cells available



Standardized cell head



Tool for removing the filter holder

Different cells for different purposes



Tablet cell 12 mm



Tablet cell 22.6 mm



Granulate &
Powder cell



Implant cell



Suppository cell



Stents cell



Tablet cell 22.6 mm
with one-way
dialysis adapter



Tablet cell 22.6 mm
with cream adapter



Tablet cell 22.6 mm
with glass beads &
tablet holder



Tablet cell 22.6 mm
with glass beads &
without tablet
holder

The entry into USP 4 testing

USP 4 Stand-alone System



The ERWEKA stand-alone flow-through cell system is perfect for performing simple release tests with manual sampling. Therefore, the flow-through cell tester DFZ II offers with the ERWEKA piston pump HKP 720 and the ERWEKA heater an easy entry into testing with USP 4 systems for a small budget.

The valve-free piston pump transports the test medium with highest precision via seven channels to the flow-through cells and automatically adopts the setting of the flow rate. With the low-vibration heater the water in the water bath can be quickly heated to the required temperature.

Highlights

100%

100%
USP/EP/JP
compliant

7x

Flow-through
cell with 7 test
stations



Simple release
testing with
manual sampling

Art. No.	USP 4 Stand-Alone System
23437	DFZ II Stand-Alone Flow-through-cell with HKP 720
23439	DFZ II Stand-Alone Flow-through-cell with HKP + temperature sensors
23440	DFZ II Stand-Alone Flow-through-cell with IPC-8

USP 4 Dissolution testing with automated analytic





USP 4 Closed Online System



The USP 4 Closed Online System is our solution with automated analytic for the USP 4 flow-through cell. The software controlled USP 4 system integrates USP 4 flow-through cell testing with directly connected analytic UV/Vis online measurement, resulting in an automated USP 4 workflow.

Furthermore, all features of the stand-alone system can be applied to our online system: the valve-free piston pump with highest precision and the low-vibration heater steadily holds the requested temperature of the waterbath. And our new and improved DFZ II USP 4 cells are also integrated into the software dialogs, making the use of the system as easy as possible.

Highlights

- 
100% USP/EP/JP conform
- 
Flow-through cell with 7 test stations
- 
Software controlled by Disso.NET
- 
Integrated UV-Vis analytic
- 
100% Audit Trail

Art. No.	USP 4 Closed Online System
27735	UV-Vis Online System DFZ II, HKP720, IPC 8, Shimadzu 1900i, Controller+Disso.NET
27736	UV-Vis Online System, HKP720, DFZ II-Temp., IPC8, Shimadzu 1900i, Controller, Disso.NET

Art. No.	USP 4 Closed On-/Offline System
27738	Closed On/Offline System, DFZ II, PT 100, Shimadzu 1900i, HKP, FRL, PC, Disso.Net
27739	Closed On/Offline System, DFZ II, Shimadzu 1900i, HKP 720, FRL 754, PC, Disso.Net

USP 4 Open Offline System



Features of the automated USP 4 Open Offline System

- Handling of unlimited media for testing of low soluble drug substances
- Fully USP compliant
- Automated sample collection
- Sampling of complete fractions into glass vials
- Sampling of representative fractions by splitting into waste and glass vials

Art. No.	USP 4 DFZ II Open Offline System
27038	Open Offline System, DFZ II with HKP 720, FRL 754, Workstation, Disso.NET USP 4
27039	Open Offline System, DFZ II, Temp. Sensor, HKP 720, FRL 754, Workstation, Disso.NET
27037	Open Offline System, DFZ II, IPC-8, FRL 754, Workstation, Disso.NET
18590	Manual switching valve for pH change USP 4
18591	Electronic switching valves 4x for pH change for up to 4 media

USP 4 Closed Offline System



Art. No.	USP 4 DFZ II Closed Offline System
27040	Closed Offline System DFZ II, HKP 720, IPC-8, FRL 754, Workstation, Disso.NET
27041	Closed Offline System DFZ II, temp. sensor, HKP 720, IPC-8, FRL 754, Workstation
17923	LMT 2 Closed Loop unit for USP 4 incl. 500 ml bottles (7 pcs)
19897	100 ml glass bottle (7 pcs.) with safety cap for LMT 2
19898	250 ml glass bottle (7 pcs.) with safety cap for LMT 2
20376	1000 ml glass bottle (7 pcs.) for LMT 2
18602	Filter for USP 4, 0.7µm, 25 pcs, 25 mm
18603	Filter for USP 4, 1.4µm, 25 pcs, 25 mm

Features of the USP 4 Closed Offline System

- Specific amount of min. 2 ml to max. 32 ml of media is pumped through the cell continually
- Media transfer station LMT 2 with 8x 1000 ml vessels
- Fully USP compliant
- Fraction collection with 3-way valves
- Long duration test runs with optimized media evaporation
- Media replacement possible

Easy media transfer with the LMT 2

With the compact ERWEKA media transfer station LMT 2 a closed loop for performing long-term dissolution tests according to USP 4 can be easily created. The LMT 2 is therefore used as a medium reservoir and ensures an optimal media mixing and distribution through the whole release test.

The optimized tubing system with a new tube holder and rotatable bottle caps (safety caps) makes handling easier and saves valuable laboratory space. Using standardized laboratory glass bottles as media vessels also enables an easier media transport for saving and further analysis. The glass bottles are available in 500 ml as standard size and optionally in the sizes 100 ml, 250 ml and 1000 ml. With the comfortable keypad the stirring speed can be easily set.



Highlights

100%

100%
USP/EP/JP
compliant



Wide range
of vessel
sizes



Improved
tubing



Optimal
media
distribution

Full dissolution software solution for Flow-Through Cell Disso.NET USP 4

The ERWEKA Disso.NET USP 4 Software is the perfect companion for our USP 4 systems. The software takes over full control of our USP 4 systems and offers support for all USP/EP dissolution cells used in these systems. It also supports cells for special applications (e.g. cell with cream adapter) and visual guides for formulation placing in the respective cells.

Disso.NET helps you with standard USP 4 dissolution jobs, handles qualifying tasks and provides control over each single function of the connected devices (e.g. pump, flow-through cell and sample collector). In addition, the software includes an easy to handle method editor for comfortable programming of dissolution methods (for highest safety in GMP environment). Our audit trail also generates detailed protocols of all events and times and thus enables tracing changes at any time.

Highlights

100%

Audit
Trail

Disso.NET

Easy control of the
USP 4 systems
with Disso.NET



MS SQL
Database



Advanced
report generati-
on



Dissolution Tester

General Options

Art. No. General Options

18334	Evaporation cover for DT HH
21795	Evaporation cover with anti-rotation device for DT HH with ASS-8/14
22342	Water stabiliser with colour indicator for DT, 100 ml blue



Water stabilizer 100 ml, blue



Evaporation cover for DT HH



Evaporation cover with anti-rotation device for DT HH with ASS-8/14 & ASS-9/18 sampling station

Art. No. CoC (Certificate of Compliance)

18395	CoC for basket, per basket
20267	CoC for basket holders for LH / HH, per holder
18414	CoC for paddle over Disk, per Disk
20268	CoC paddle, per paddle
20269	CoC for shaft LH / HH, per shaft
22444	CoC for bundle, paddle, basket holder
18369	CoC for vessels, per vessel
20272	CoC for mini vessel, per vessel
22449	CoC for rotating cylinder, per rotating cylinder

Vessels and Mini Vessels

Art. No. Vessels

18365	Vessel for DT, glass, 1000 ml, numbered
18366	Vessel for DT, UV-resistant amber glass, 1000 ml, numbered
18367	Vessel for DT, glass, 2000 ml, numbered
18368	Vessel for DT, UV-resistant amber glass, 2000 ml, numbered
19115	Apex Vessel for DT, glass, 1000 ml

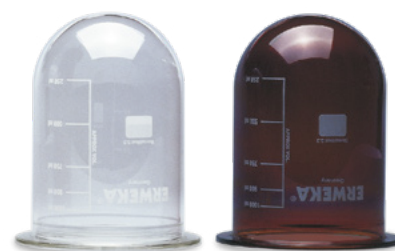

Glass vessel and UV-resistant vessel



100ml and 400ml Vessel

Art. No. Mini vessels

18373	Mini vessel for DT, glass, 400 ml, numbered
18374	Mini vessel for DT, UV-resistant amber glass, 400 ml
18375	Conversion ring for 400 ml Minivessel (excluding vessel)
18378	Automated sampling station (LH) for Mini vessel 400 ml, for DT 72x/82x
19978	Automated sampling station (HH) for Mini vessel 400 ml, for DT 72x/82x
22399	Conversion set 1000 ml to 400 ml including Mini vessel and Mini paddle LH
22398	Conversion set 1000 ml to 400 ml including Mini vessel and Mini paddle HH

The 400 ml Mini vessel apparatus is a reduced scale of the USP method 2, commonly used for low-dose formulations and poorly available drugs.

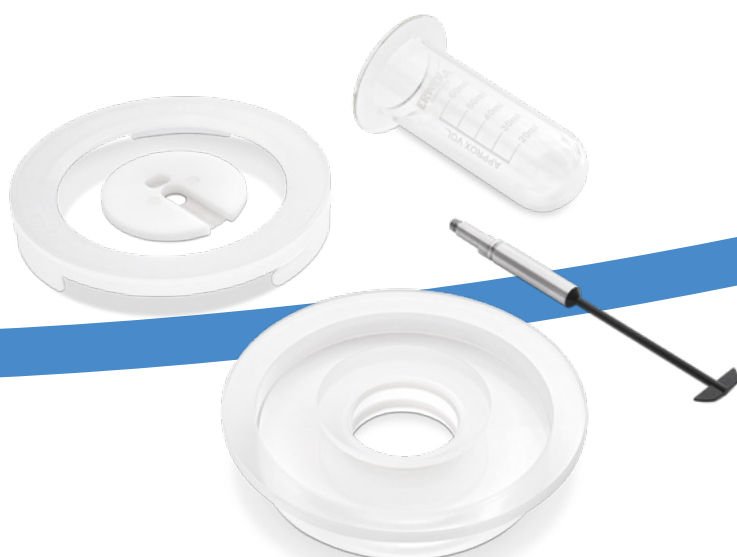

Dissolution Accessories

Art. No. DT Shafts for USP Methods 1, 2, 5, 6

22391	Shaft unit LH for basket or paddle (st. steel) or Bundle (st. steel), incl. carrier, numbered
22436	Shaft unit LH for paddle (PTFE coated), numbered
22438	Shaft set (2) LH for bundle basket holder + PTFE coated paddle, numbered
22393	Shaft LH 2000 ml for basket, paddle (st. steel) or bundle (st. steel)
22394	Shaft unit HH for Basket or Paddle (st. steel) or Bundle (st. steel), numbered
22437	Shaft unit HH for PTFE coated Paddle, numbered
22439	Shaft set (2) HH for Bundle basket holder + PTFE coated paddle, numbered
22396	Shaft HH 2000 ml for basket, paddle (st. steel), or bundle (st. steel)

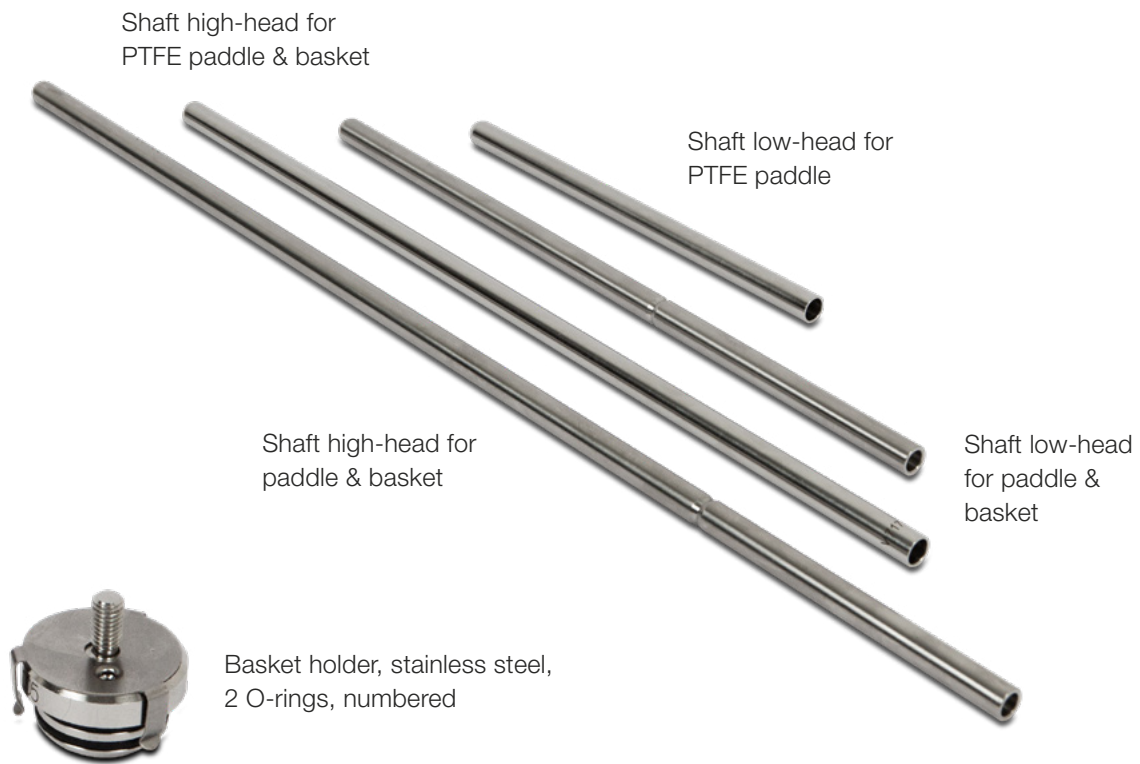

Art. No. Baskets USP 1

22402	Basket holder, stainless steel, numbered
18391	Basket, mesh 10, stainless steel, numbered
18392	Basket, mesh 20, stainless steel, numbered
18393	Basket, mesh 40, stainless steel, numbered
18394	Suppository basket, plastic



Baskets mesh 10, 20 and 40 (standard)

Art. No. Paddles USP 2

22403	Paddle, stainless steel, numbered
22404	Paddle (PTFE coated) for 1000 ml, numbered
22405	Paddle (PTFE coated) for 2000 ml, numbered
22406	Bundle, paddle and basketholder, stainless steel, numbered
22407	Bundle, paddle (PTFE coated), and basket holder, stainless steel, numbered



Paddle, stainless steel, numbered



Bundle, paddle (PTFE coated) & basket holder, stainless steel

Art. No. Paddle over Disk USP 5

18412	Height Adjustment tool Paddle over Disk USP 5 Distance
18413	Paddle over Disk USP 5, incl. sieve mesh 125 μm , numbered



Paddle over Disk USP 5, for holding transdermal patch, mesh 125 μm , numbered



Rotating Cylinder

Art. No. Rotating Cylinders USP 6

- | | |
|-------|---|
| 22408 | Rotating cylinder, stainless steel, short, numbered |
| 22409 | Rotating cylinder, stainless steel, long, numbered |



Extraction Cell

Art. No. Extraction Cell

- | | |
|-------|--|
| 18421 | Extraction cell, ID=20/27 mm, acc. to EP 2.9.4 |
| 22252 | Extraction cell, ID=32/38 mm, acc. to EP 2.9.4 |
| 22253 | Extraction cell, ID=40/45 mm, acc. to EP 2.9.4 |
| 22254 | Extraction cell, ID=50/52 mm, acc. to EP 2.9.4 |

Art. No. Felodipine basket

- | | |
|-------|--|
| 18422 | Felodipine stationary basket for low-head use |
| 18423 | V-shaped low head vessel cover (plastics) for fixing Felodipine basket |
| 18424 | V-shaped vessel cover (PTFE coated) for fixing Felodipine basket |
| 18425 | Felodipine stationary basket for high-head use |
| 18426 | Low-evaporation high-head vessel cover (plastics) for fixing Felodipine basket |
| 22411 | ERWEKA Wood Apparatus (intrinsic) for 1 test station |
| 18429 | Manual hydraulic press for Wood Apparatus |

Wood Apparatus for 1 test station

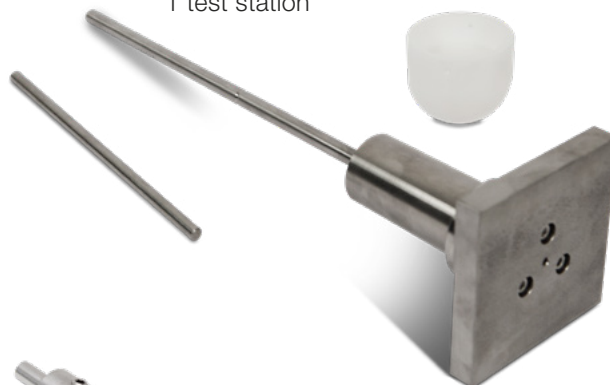

Felodipine stationary basket

Art. No. Sinkers

18379 Japanese sinkers, set of 6 pcs, stainless steel, USP compliant

18380 Spider sinkers, plastic, set of 6 pcs



Japanese sinkers, set of 6



Spider sinkers, plastic, set of 6

Art. No. Enhancer Cell

22400 Enhancer cell set, incl. 200 ml vessel round bottom and mini paddle HH shaft

22401 Enhancer cell set incl. 200 ml flat bottomed glass, mini paddle, HH shaft

18382 Vessel for Enhancer cell, 200 ml, glass, rounded bottom

18384 Enhancer cell (fluoropolymer) for testing creams, ointments, gels

21612 Vessel for Enhancer cell, 200 ml, glass, flat bottom



Enhancer Cell

Consumables

Art. No. Inline Filters

18430	Filters (1.000 pcs), Poroplast, 1 µm
18431	Filters (1.000 pcs), Poroplast, 4 µm
18432	Filters (1.000 pcs), Poroplast, 10 µm
21702	Filters (10.000 pcs), Poroplast, 10 µm
18433	Filters (1.000 pcs), Poroplast, 20 µm

Mechanical Calibraion

Art. No. Tools Mechanical Calibration

18437	Dissolution tester qualification kit
18438	Dissolution tester validation kit according to FDA, certified
18439	Qualification kit (upgrade) according to Mechanical Calibration standards of FDA
18440	USP 5 Calibration Tool for height measurement, certified

Documents

Art. No. QA Dokumente

26980	IQ documents DT 126/128 Light / DT 62x, DT 72x, DT 82x, DT 95x
26981	OQ documents DT 16/128 Light, DT 62x, DT 72x, DT 82x, DT 95x
26979	IQ documents DT 1212 Light / DT 141x / 161x
26982	OQ documents for DT 1212 Light, DT 141x, DT 161x
25150	PVT Documents for all DT Dissolution Tester
25850	FIP (Final Inspection Protocol) for DT Dissolution Tester

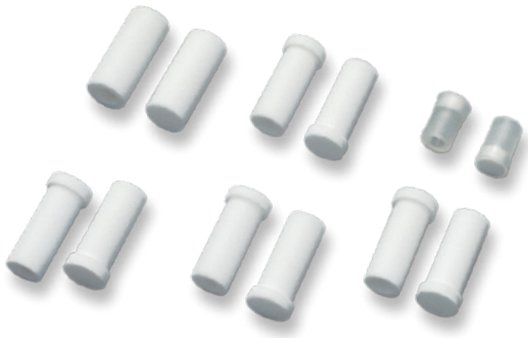

Different types of filters

Art. No. PVT Reference Tablets

- 18441 Prednisone tablets, 1 pack (30 pcs)
- 18442 Prednisone, 250 mg



Reference Tablets



Tools Mechanical Calibration

Manual Sampling

Art. No. Manual Sampling

18357	Manual sampling cannula LH USP 1 (basket), stainless steel
18355	Manual sampling cannula LH USP 2 (paddle), stainless steel
18361	Manual sampling cannula HH USP 1 (basket), stainless steel
20422	Manual sampling cannula HH USP 2 (paddle), stainless steel

Automated Sampling

Art. No. Automated Sampling

18350	Cleaning reservoir (acrylic glass) for ASS-8/ASS-9 (DT 72x/82x/95x)
18352	Cleaning- and calibrationreservoir for ASS-8/ASS-9 sampling station with Disso.NET
18351	Cleaning reservoir (acrylic glass) for ASS-14/ASS-18 with DT 141x/161x/951x
23208	Cleaning- and calibrationreservoir for ASS-14/ASS-18 sampling station with Disso.NET



Automated sampling station
ASS-9 on top of a DT from the
DT 950 series

DT 950 Options

Art. No. DT 950 Options

27237	Manual tool for configuring sampling height 1000ml, USP1 und USP2
27818	Manual tool for configuring sampling height 2000ml, USP1 und USP2
27780	1-Station upgrade DT 95x / DT 951x
27345	Automated tablet drop magazine for DT 95x LH
27580	Retrofit kit for automatic tablet drop
27241	Manual sampling cannula, LH, USP 1 und USP 2 (Basket & Paddle)
27244	Manual sampling cannula, HH, USP 1 und USP 2 (Basket & Paddle)
27460	ASS-9 LH automatic sampling station, PTFE coated tubing 3.0 mm, DT 95x
27461	ASS-9 LH automatic sampling station, with 8 temperature sensors DT 95x
27563	ASS-9 HH automatic sampling station, PTFE coated tubing 3.0 mm, DT 95x
27462	ASS-9 HH automatic sampling station, with 8 temperature sensors DT 95x

Manual sampling cannula, LH USP 1 with syringe connected to stainless steel sampling probe



Manual sampling cannula, HH USP 1 with syringe connected to stainless steel sampling probe

Syringe connected to stainless steel sampling probe

Dissolution System Options



Art. No. Filtration

18497 AFC 825 - 12 V membrane filter exchange system for 6 stations

18499 AFC 825 - 16 V membrane filter exchange system for 8 stations

AFC automatic membrane filter exchange system

Art. No. FRL sample collector racks

26990 Rack 26 x 8 for 12 ml glass tubes

26991 Rack 18 x 8 for 25ml glass tubes

18509 Rack for 26 x 8 HPLC vials, 1.8 ml

18510 Rack for 26 x 8 HPLC vials, 4.0 ml

18511 Recalibration rack for HPLC vials 1.8 ml and 4.0 ml



Rack with HPLC vials

Art. No. Others

23172 Metrohm pH Meter for connection to Disso.NET



Sampling into UV-Vis glass tubes

Art. No. Glass tubes for FRL

18512	Glass tubes 12 ml for FRL, 100 pcs.
18513	Glass tubes 25 ml for FRL, 100 pcs.
18514	Glass tubes amber glass 25 ml, 100 pcs.

Art. No. Cuvettes for UV/Vis

18521	Cuvette, 10 mm path length, flow-through optimised (standard)
18518	Cuvette, 1 mm path length
18520	Cuvette, 5 mm path length

Art. No. QA Documents

18529	IQ/OQ documents Offline System for first installation
27548	SOP Add-On Dissolution System w. Disso.NET, photometer, FRL or HPLC sampler (EN)
20952	OQ documents Offline System
27545	SOP Add-On Dissolution System w. Disso.NET, photometer, FRL o. HPLC Sampler (DE)
26374	SOP AVT Automation Verification Test Diss. Systems (DE)
27706	IQ Add-On Dissolution systems with Disso.NET, FRL and/or Photometer (UV)
27707	IQ Add-On Dissolution systems with Disso.NET, HPLC-connection (and UV)
27708	OQ Add-On Dissolution systems with Disso.NET, FRL and/or Photometer (UV)
27709	OQ Add-On Dissolution systems with Disso.NET, HPLC-connection (and UV)
24958	AVT documents for Offline, Online, On-/Offline, RoboDis Systems
26374	SOP AVT Automation Verification Test Diss. Systems
25860	FAT Protocol Dissolution Systems
26870	System inspection protocol SIP for DT System with Disso.NET
26871	Final inspection protocol for Offline system



Contact

Are you curious and want to find out more?
Head over to our website and download our product brochures,
watch videos of our equipment in action or find the ERWEKA
dealer of your country.



E-Mail: sales@erweka.com
Tel.: +49 6103 92426-200
Fax: +49 6103 92426-999



support@erweka.com



www.erweka.com



spareparts@erweka.com



www.facebook.com/erweka.gmbh

ERWEKA GmbH

Pittlerstr. 45
63225 Langen
Germany

E-Mail: sales@erweka.com
Phone: +49 6103 92426-200
Fax: +49 6103 92426-999

Technical specifications of products described are
stated without warranty and subject to change at
any time without further notice. **v.3.8.1.23**

ERWEKA