

Technical documentation

MiNexx-link-E

PR 5215/00

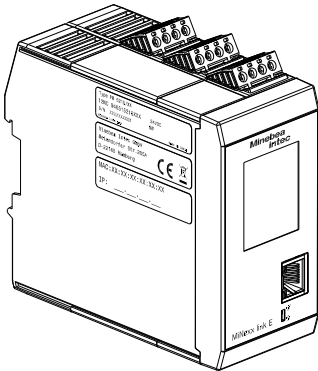

PR 5215/01

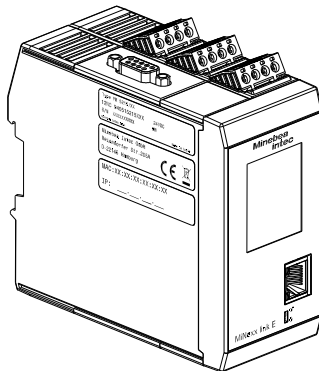

PR 5215/04, ..05

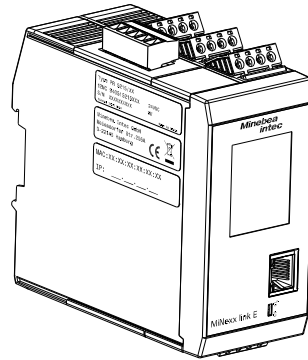

PR 5215/06, ..07, ..08

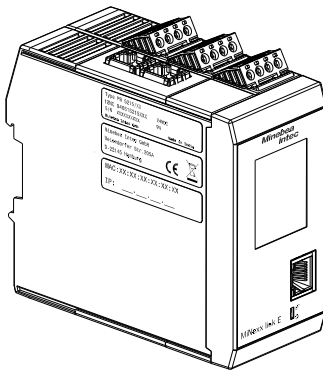

PR 5215/10

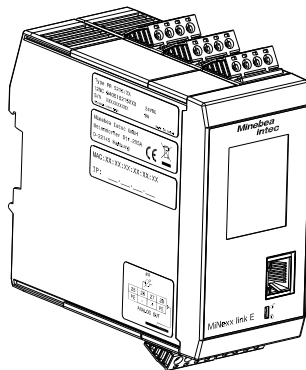

PR 5215/11

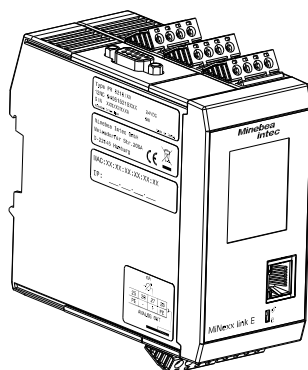

Foreword

Must be followed!

Any information in this document is subject to change without notice and does not represent a commitment on the part of Minebea Intec unless legally prescribed. This product should only be operated/installed by trained and qualified personnel. In correspondence concerning this product, the type, name, and release number/serial number as well as all license numbers relating to the product have to be cited.

Note

This document is partially protected by copyright. It may not be changed or copied, and it may not be used without purchasing or written permission from the copyright owner (Minebea Intec). The use of this product constitutes acceptance by you of the abovementioned provisions.

Contents

1	Introduction	7
1.1	Read the safety instructions and the manual	7
1.2	This is what operating instructions look like	7
1.3	This is what lists look like	7
1.4	This is what warnings look like	7
1.5	Hotline	8
2	Safety instructions	9
2.1	General instructions	9
2.2	Intended use	9
2.3	Initial inspection	9
2.4	Before operational startup	10
2.4.1	Installation	10
2.4.2	Use in Ex zones	10
2.4.3	Opening the device	10
2.4.4	Supply voltage connection	11
2.4.5	Protective ground connection	11
2.4.6	RF interference suppression	11
2.4.7	Failure and excessive stress	11
2.4.8	Important note	12
2.4.9	Repairs and maintenance	12
3	Device description	14
3.1	Transmitter types	14
3.1.1	General information	14
3.1.2	PR 5215/00	14
3.1.3	PR 5215/01	15
3.1.4	PR 5215/04	16
3.1.5	PR 5215/05	17
3.1.6	PR 5215/06	18
3.1.7	PR 5215/07	19
3.1.8	PR 5215/08	20
3.1.9	PR 5215/10	21
3.1.10	PR 5215/11	22
3.2	Overview of the device	23
3.2.1	Communication protocols	23
3.3	Housing	24
3.3.1	Housing dimensions	24
3.3.2	Indicator front	25
3.3.3	Overview of connections	26

3.3.4	Sticker	28
4	Device installation	29
4.1	General instructions	29
4.2	Mechanical preparation	30
4.2.1	Storage and transport conditions	30
4.2.2	Installation location	30
4.2.3	Unpacking	31
4.2.4	Checking the equipment supplied	31
4.2.5	Acclimatizing the device	31
4.2.6	cable connection	31
4.2.7	EMC-compliant installation	31
4.3	Hardware construction	33
4.3.1	Network port	33
4.3.2	RS-485 interface	34
4.3.3	Digital inputs	35
4.3.4	Digital outputs (relay outputs)	37
4.3.5	Connection of analog load cells and platforms	39
4.3.6	Analog output	47
4.3.7	ProfiBus-DP interface	49
4.3.8	DeviceNet interface	52
4.3.9	CC-Link interface	54
4.3.10	ProfiNet I/O interface	55
4.3.11	EtherNet/IP interface	57
4.3.12	EtherCAT interface	59
5	Getting started	61
5.1	Switching on the device	61
5.2	Switching off the device	61
5.3	Device warm-up time	61
5.4	Power failure	61
5.5	Connect device to the network	62
5.5.1	Connecting device to the network via DHCP	62
5.5.2	Connecting device to the network via static IP address	63
5.6	Data backup	66
5.7	Overwrite protection	67
5.7.1	CAL switch	67
5.8	Performing a factory reset on the device	68
6	Operating	69
6.1	Operating and display elements	69
6.1.1	TFT Color touch display	69
6.1.2	WEB display	70
6.1.3	Message dialog	74

6.2	Display menu	75
6.3	WEB menu	78
6.3.1	Weighing points	78
6.3.2	Application settings	80
6.3.3	Interfaces	80
6.3.4	System	83
6.3.5	Service	83
6.4	Assign password	84
6.5	Change password	86
6.6	Error logging in	87
6.7	Select language	88
6.8	Current date & time	89
6.9	Serial interface	90
6.10	Digital inputs & outputs	90
6.11	Defining limits	91
6.12	Configuring the analog output	93
6.13	Metrology parameters	95
6.14	Calibrating internal weighing point	98
6.14.1	General instructions	98
6.14.2	Performing a new adjustment	99
6.14.3	Modifying a adjustment	105
7	ModBus protocol	106
7.1	General description	106
8	SMA protocol	107
8.1	General description	107
9	Fieldbus interface	108
9.1	General notes	108
9.2	Scale protocol	108
9.2.1	Data exchange range	109
9.2.2	Reading and writing data with function numbers	112
9.2.3	Reading and writing bits directly	114
9.2.4	Waiting for the result of the action	115
9.2.5	Function numbers	116
9.2.6	Example: reading the gross weight	125
9.2.7	Special note for DeviceNet and EtherNet/IP	127
10	SPM	128
10.1	General notes	128
10.2	Elementary data types	128
10.3	Addressing	129

10.4	System data	130
11	Error messages	133
11.1	Error messages measuring circuit	133
11.2	Error numbers @ "LAST_ERROR"	134
11.2.1	Weighing point error	134
12	Maintenance/repairs/cleaning	135
12.1	Maintenance	135
12.2	Repairs	135
12.3	Cleaning	136
12.3.1	Instructions for cleaning	136
13	Safety inspection	137
14	Disposal	138
15	Specification	139
15.1	Equipment supplied	139
15.2	General technical data	139
15.2.1	Date/time buffer	139
15.2.2	Touch Display	139
15.2.3	Supply voltage connection version 24 V DC	139
15.3	Effect of ambient conditions	140
15.3.1	Ambient conditions	140
15.3.2	Electromagnetic Compatibility (EMC)	140
15.3.3	RF interference suppression	141
15.4	Weighing electronics data	141
15.4.1	Load cells	141
15.4.2	Principle	142
15.4.3	Accuracy and stability	142
15.4.4	Sensitivity	142
15.4.5	Connecting cables	143
15.5	Mechanics	143
15.5.1	Housing	143
16	Appendix	144
16.1	Certificates	144
16.1.1	MEU22001	145

1 Introduction

1.1 Read the safety instructions and the manual

- Please read the safety instructions and this manual carefully and completely before using the product.
- These are part of the product. Keep the safety instructions in a safe and easily accessible location.

1.2 This is what operating instructions look like

1. - n. are placed before steps that must be done in sequence.

- ▶ is placed before a step.
 - ▷ describes the result of a step.

1.3 This is what lists look like

- indicates an item in a list.

1.4 This is what warnings look like

Signal words indicate the severity of the danger involved when measures for preventing hazards are not followed.

DANGER

Warning of personal injury



DANGER indicates death or severe, irreversible personal injury which will occur if the corresponding safety measures are not observed.

- ▶ Take the corresponding safety precautions.

WARNING



Warning of hazardous area and/or personal injury

WARNING indicates that death or severe, irreversible injury may occur if appropriate safety measures are not observed.

- ▶ Take the corresponding safety precautions.

CAUTION



Warning of personal injury.

CAUTION indicates that minor, reversible injury may occur if appropriate safety measures are not observed.

- ▶ Take the corresponding safety precautions.

NOTICE

Warning of damage to property and/or the environment.

NOTICE indicates that damage to property and/or the environment may occur if appropriate safety measures are not observed.

- ▶ Take the corresponding safety precautions.

Note: User tips, useful information, and notes.

1.5 Hotline

Phone: +49.40.67960.444

Fax: +49.40.67960.474

E-mail: help@minebea-intec.com

2 Safety instructions

2.1 General instructions

NOTICE

Warning of damage to property and/or the environment.

The device complies with the directives and standards on electrical equipment, electromagnetic compatibility, and the prescribed safety requirements. However, improper use can cause damage to persons and property.

The device was in perfect condition with regard to safety features when it left the factory.

- ▶ To maintain this condition and to ensure safe operation, the user must follow the instructions and observe the warnings in this manual.

2.2 Intended use

The device is intended for use of the indicator for weighing functions.

Device operation, commissioning and maintenance must be performed by trained and qualified personnel who are aware of and able to deal with the related hazards and take suitable measures for self-protection.

The device reflects the state of the art.

No warranty is given that the device is free of faults, especially not in conjunction with third-party software and hardware components required for operation.

The manufacturer does not accept any liability for damage caused by third-party system components or due to incorrect use of the device. The use of this device signifies recognition of the stipulations listed above.

2.3 Initial inspection

Check the contents of the consignment for completeness. Check the contents visually to determine whether any damage has occurred during transport.

If there are grounds for rejection of the goods, a claim must be filed with the carrier immediately. A Minebea Intec sales or service organization must also be notified.

2.4 Before operational startup

NOTICE

Visual inspection!

Before operational startup as well as after storage or transport, inspect the product visually for signs of mechanical damage.

- ▶ The device should not be put into operation if it displays signs of visible damage and/or is defective.

2.4.1 Installation

The device is designed for mounting rail installation (35 mm, as per DIN 46277).

The device has to be installed in an EMC-compliant manner, see Chapter [EMC-compliant installation](#).

To ensure proper cooling of the device, make sure air circulation around the device is not blocked. Avoid exposing the instrument to excessive heat, e.g. from direct sunlight and vibrations. The ambient conditions specified in Chapter [Ambient conditions](#) must be observed at all times.

With outdoor mounting, make sure that adequate weather protection is provided (for temperatures, see Chapter [Ambient conditions](#)).

2.4.2 Use in Ex zones

The indicator PR 5215 may not be used in potentially explosive atmospheres.

2.4.3 Opening the device

WARNING

Working on a device that is switched on can have life-threatening consequences.

When removing covers or parts using tools, live parts may be exposed. Please note that capacitors in the device may still be charged even after disconnecting the device from all voltage sources.



- ▶ The device may only be opened by skilled service personnel in accordance with Minebea Intec specifications.
- ▶ Disconnect the device from the electrical supply.

This device contains electrostatically sensitive components. Therefore, potential equalization must be provided when working on the device (antistatic protection).

Before connecting or disconnecting additional devices from the data outputs, the device must be disconnected from the mains.

2.4.4 Supply voltage connection

Supply voltage $U_{DC} = 24 \text{ V} +10\%/-15\%$

The max. power consumption is 9 W.

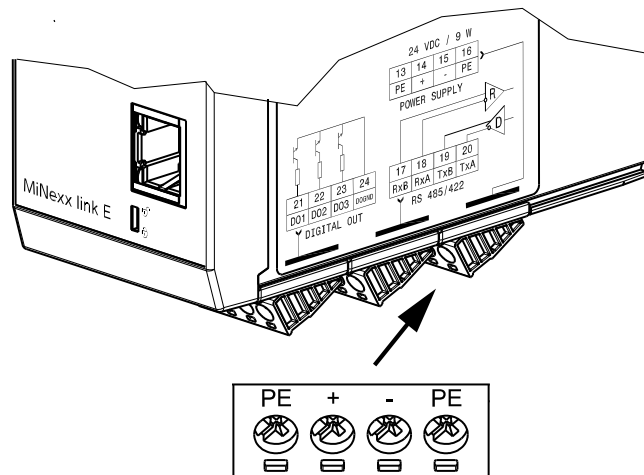

The connection diagram is located on the right side of the housing.

For a connection to 230/115 V alternating current, an external power supply is required.

2.4.5 Protective ground connection

The protective ground connection is made via the mounting rails.

2.4.6 RF interference suppression

The device is intended for use in an industrial environment. Operation of this device in a residential environment is likely to cause radio frequency interference, see Chapter [RF interference suppression](#). In this case, the operator may be required to take appropriate measures.

2.4.7 Failure and excessive stress

If there is any reason to assume that safe operation of the device is no longer ensured, shut it down and make sure it cannot be used.

Safe operation is no longer ensured if any of the following is true:

- The device is physically damaged.
- The device does not function.
- The device has been subjected to stresses beyond the tolerance limits (e.g., during storage or transport).

2.4.8 Important note

Make sure that the construction of the device is not altered to the detriment of safety. In particular, leakage paths, air gaps (of live parts) and insulating layers must not be reduced.

Minebea Intec cannot be held responsible for personal injury or property damage caused by a device repaired incorrectly by an operator or installer.

2.4.9 Repairs and maintenance

2.4.9.1 General information

Repairs are subject to inspection and must be carried out at Minebea Intec.

In case of defect or malfunction, please contact your local Minebea Intec dealer or service center for repair.

When returning the device for repair, please include a precise and complete description of the problem.

Maintenance work may only be carried out by authorized technical personnel with expert knowledge of the hazards involved and the required precautions.

2.4.9.2 Electrostatically sensitive components

This device contains electrostatically sensitive components. Therefore, potential equalization must be provided when working on the device (antistatic protection).

2.4.9.3 Replacing fuses

The device does not have any replaceable fuse.

The load cell supply is protected against short circuit.

In case of loss of load cell supply, disconnect the device from the supply voltage, find out the cause and eliminate it.

After a cool down time of approx. 3 minutes, the supply voltage can be switched on again.

3 Device description

3.1 Transmitter types

3.1.1 General information

The transmitters in the PR 5215 series come in 9 expansion stages. Subsequent expansion of the expansion stage is not possible. The respective type is clearly designated by the corresponding number.

All of the devices are equipped with a touchscreen.

3.1.2 PR 5215/00

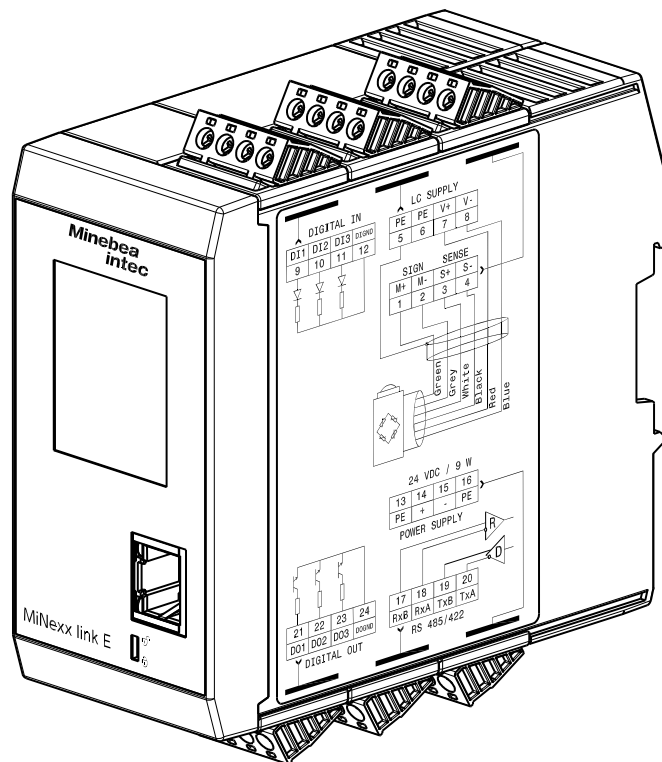

This type includes

- 3 digital inputs and outputs
- a port for the analog weighing electronics (ADC)
- a supply voltage connection
- a RS-485 interface
- a network port

See also Chapter [Overview of connections](#).

3.1.3 PR 5215/01

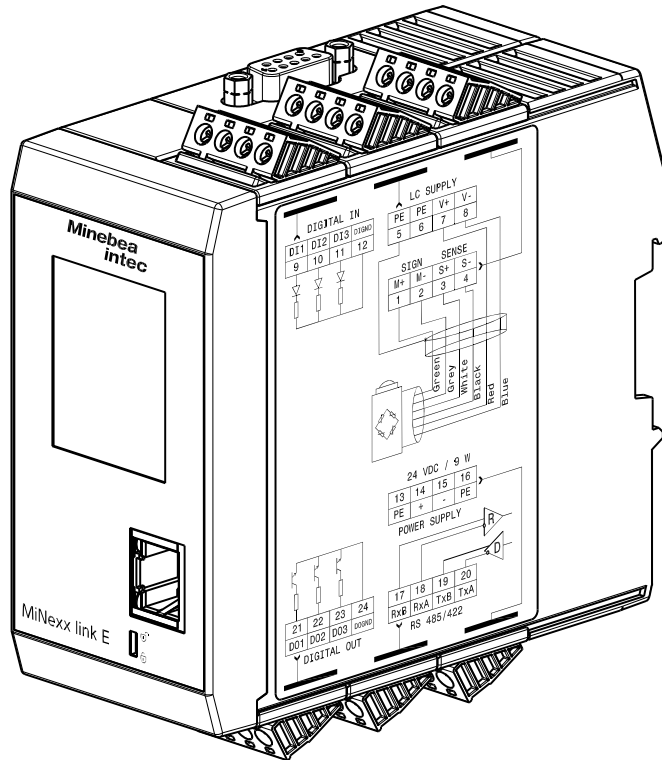

This type includes

- 3 digital inputs and outputs
- a port for the analog weighing electronics (ADC)
- a supply voltage connection
- a RS-485 interface
- a network port
- a ProfiBus-DP interface

The ProfiBus-DP connection is established by D-Sub 9-pin plug connector (female) on the top of the device.

See also Chapter [Overview of connections](#).

3.1.4 PR 5215/04

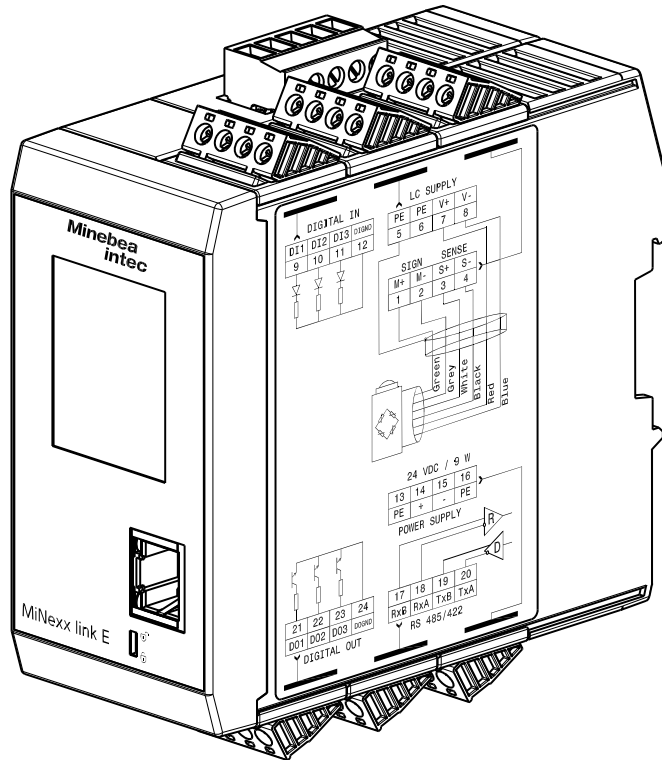

This type includes

- 3 digital inputs and outputs
- a port for the analog weighing electronics (ADC)
- a supply voltage connection
- a RS-485 interface
- a network port
- a DeviceNet interface

The DeviceNet connection is established by 5-pin plug connector (female) on the top of the device.

See also Chapter [Overview of connections](#).

3.1.5 PR 5215/05

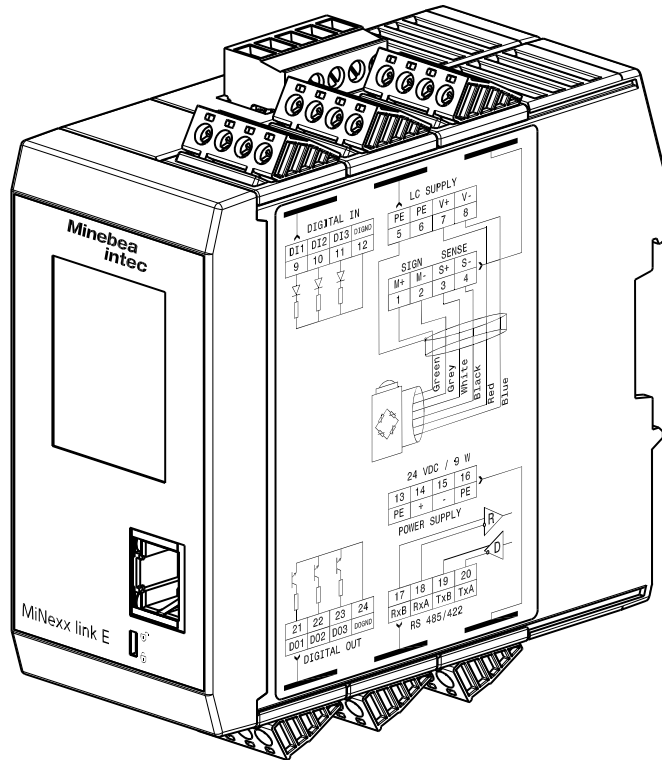

This type includes

- 3 digital inputs and outputs
- a port for the analog weighing electronics (ADC)
- a supply voltage connection
- a RS-485 interface
- a network port
- a CC-Link interface

The CC-Link connection is established by 5-pin plug connector (female) on the top of the device.

See also Chapter [Overview of connections](#).

3.1.6 PR 5215/06

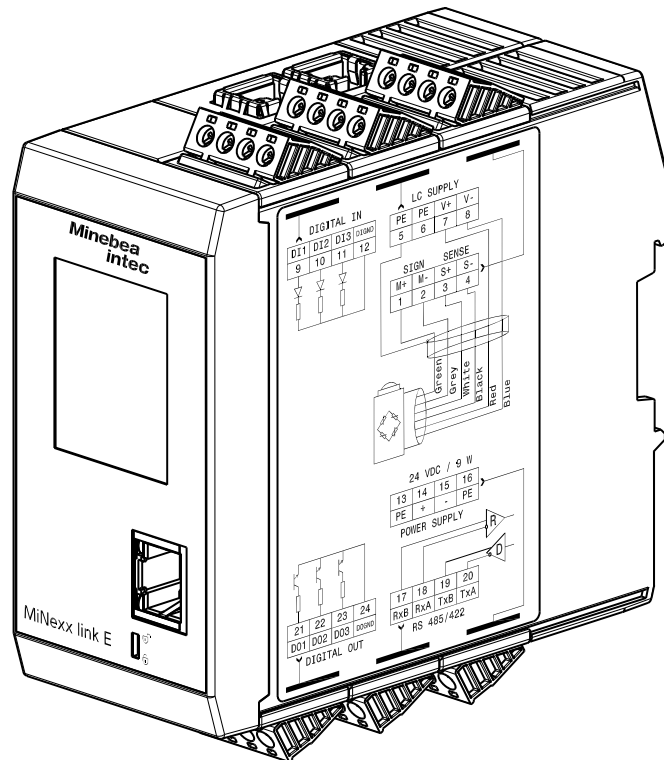

This type includes

- 3 digital inputs and outputs
- a port for the analog weighing electronics (ADC)
- a supply voltage connection
- a RS-485 interface
- a network port
- a ProfiNet I/O interface

The ProfiNet I/O connection is established by RJ-45 plug connector (2×, female) on the top of the device.

See also Chapter [Overview of connections](#).

3.1.7 PR 5215/07

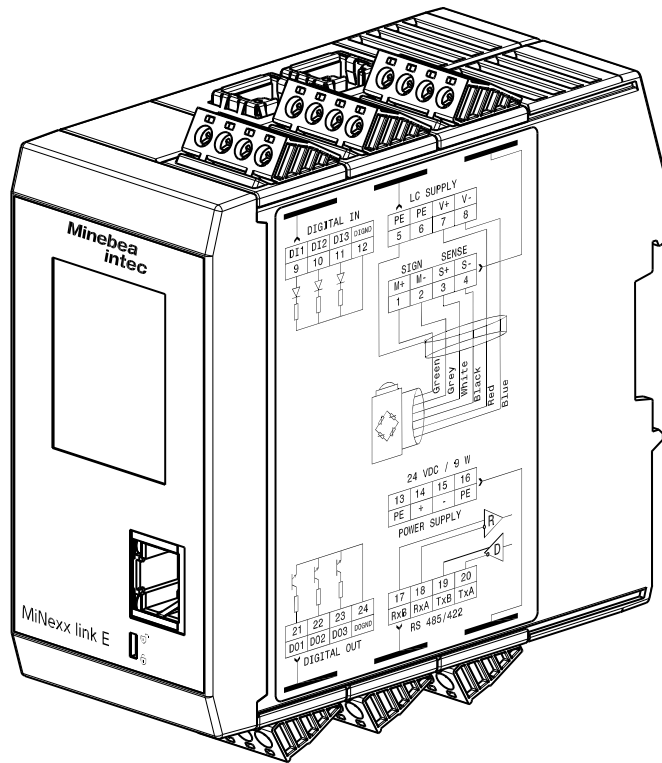

This type includes

- 3 digital inputs and outputs
- a port for the analog weighing electronics (ADC)
- a supply voltage connection
- a RS-485 interface
- a network port
- an EtherNet/IP interface

The EtherNet/IP connection is established by RJ-45 plug connector (2x, female) on the top of the device.

See also Chapter [Overview of connections](#).

3.1.8 PR 5215/08

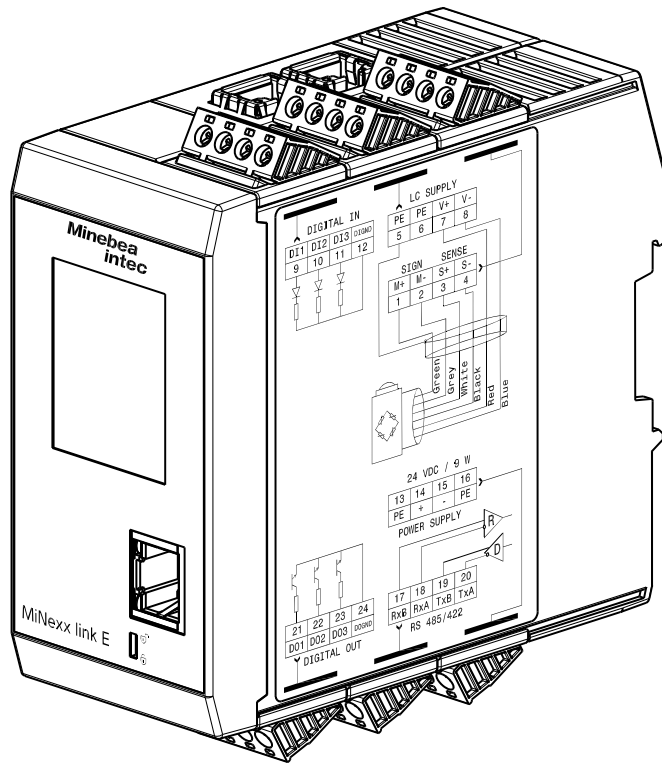

This type includes

- 3 digital inputs and outputs
- a port for the analog weighing electronics (ADC)
- a supply voltage connection
- a RS-485 interface
- a network port
- an EtherCAT interface

The EtherCAT connection is established by RJ-45 plug connector (2×, female) on the top of the device.

See also Chapter [Overview of connections](#).

3.1.9 PR 5215/10

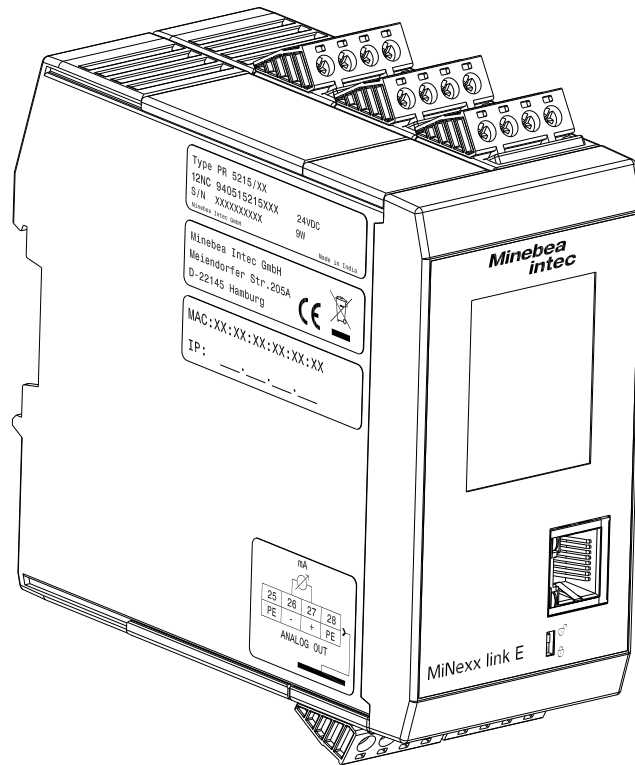

This type includes

- 3 digital inputs and outputs
- a port for the analog weighing electronics (ADC)
- a supply voltage connection
- a RS-485 interface
- a network port
- an analog output

See also Chapter [Overview of connections](#).

3.1.10 PR 5215/11

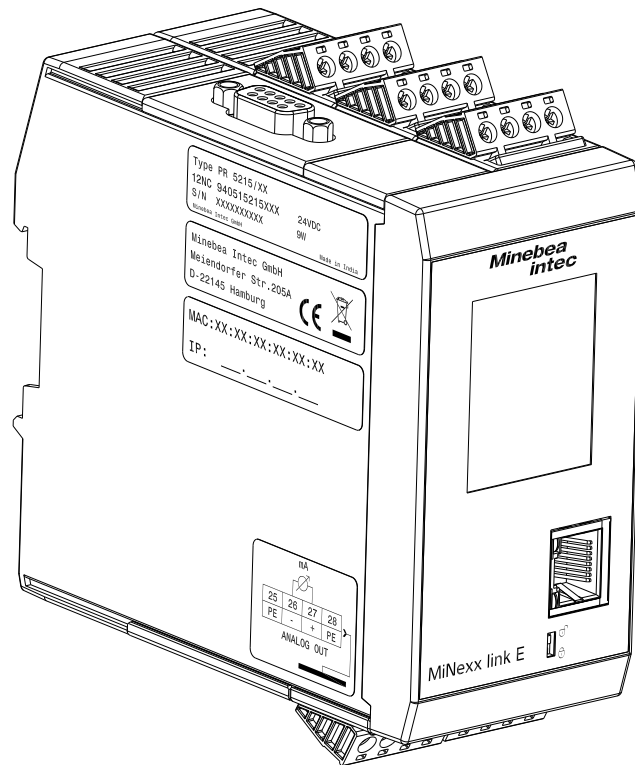

This type includes

- 3 digital inputs and outputs
- a port for the analog weighing electronics (ADC)
- a supply voltage connection
- a RS-485 interface
- a network port
- a Profibus-DP interface
- an analog output

Note: The Profibus-DP interface and the analog output are located on a so-called CombiCard.

The Profibus-DP connection is established by D-Sub 9-pin plug connector (female) on the top of the device.

See also Chapter [Overview of connections](#).

3.2 Overview of the device

- Accuracy 6,000 d (Class III) for the weighing electronics
- High-speed conversion with response times from upto 10 ms
- Weight display with status and mass unit on a TFT Color touch display
- Digital filter with adjustable characteristic line
- Electrically isolated interfaces
- 3 programmable pairs of limits
- Supply voltage connection $U_{DC} = 24\text{ V}$
- Connection via plug connector for load cells, inputs and outputs, serial interfaces
- Ethernet connection
- The device is snapped to a mounting rail.

The menu-guided adjustment and configuration of the device are carried out on a notebook/PC via ethernet.

- Adjustment using weights according to the mV/V method or directly using load cell data (SMART calibration)
- Analog output 0/4 to 20 mA, configurable for gross/net weight (only PR 5215/10 and ../11)
- Analog weight value via field bus
- 3 digital inputs, electrically isolated
- 3 digital outputs, electrically isolated
- Overwrite protection:
via CAL switch (on the front of the device)

3.2.1 Communication protocols

For RS-485:

- Remote display protocol
- SMA protocol
- ModBus-RTU protocol

Field bus slave:

- ProfiBus-DP
- DeviceNet
- CC-Link
- ProfiNet I/O
- EtherNet/IP
- EtherCAT

For the LAN interface:

- ModBus-TCP
- Ethernet TCP/IP
- OPC

3.3 Housing

3.3.1 Housing dimensions

Example: PR 5215/00

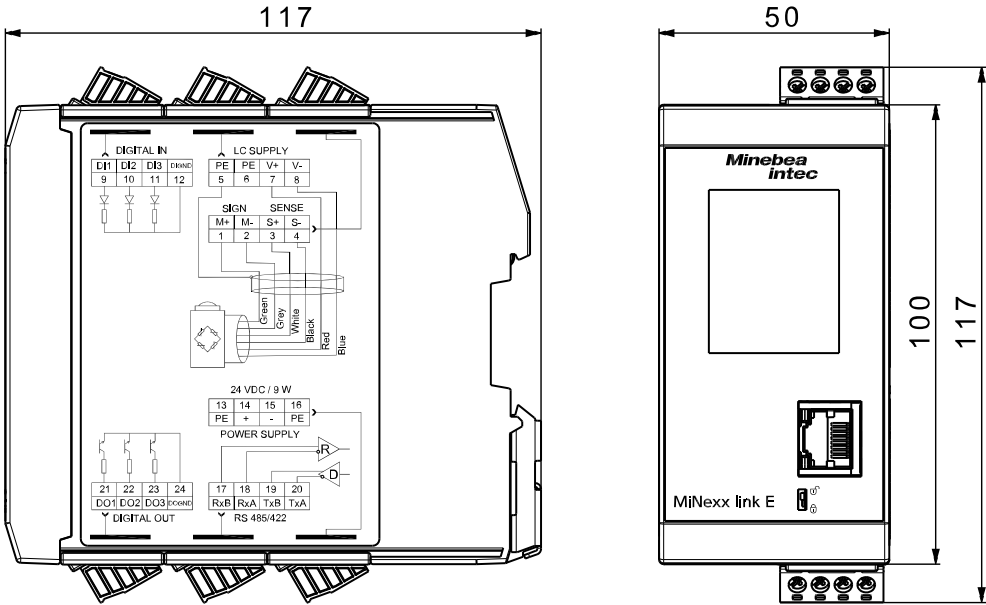

All dimensions in mm.

3.3.2 Indicator front

Pos.	Name
1	TFT Color touch display 1.77"
2	Ethernet port
3	CAL switch

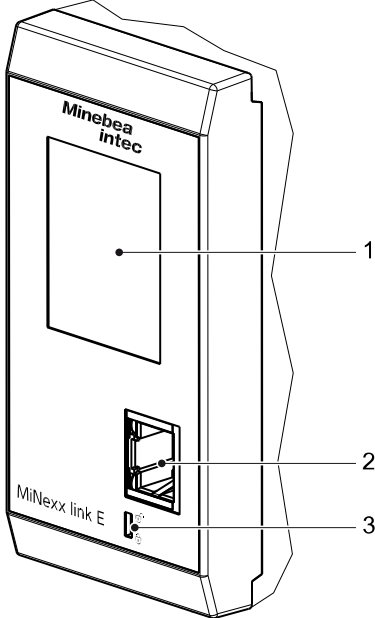

The diagram shows the front panel of a Minebea Intec MiNexx link E device. It features a 1.77-inch TFT color touch display at the top, an Ethernet port in the middle, and a CAL switch at the bottom. The device is labeled 'Minebea Intec' at the top and 'MiNexx link E' at the bottom. Three callout lines point to the display (1), the Ethernet port (2), and the CAL switch (3).

3.3.3 Overview of connections

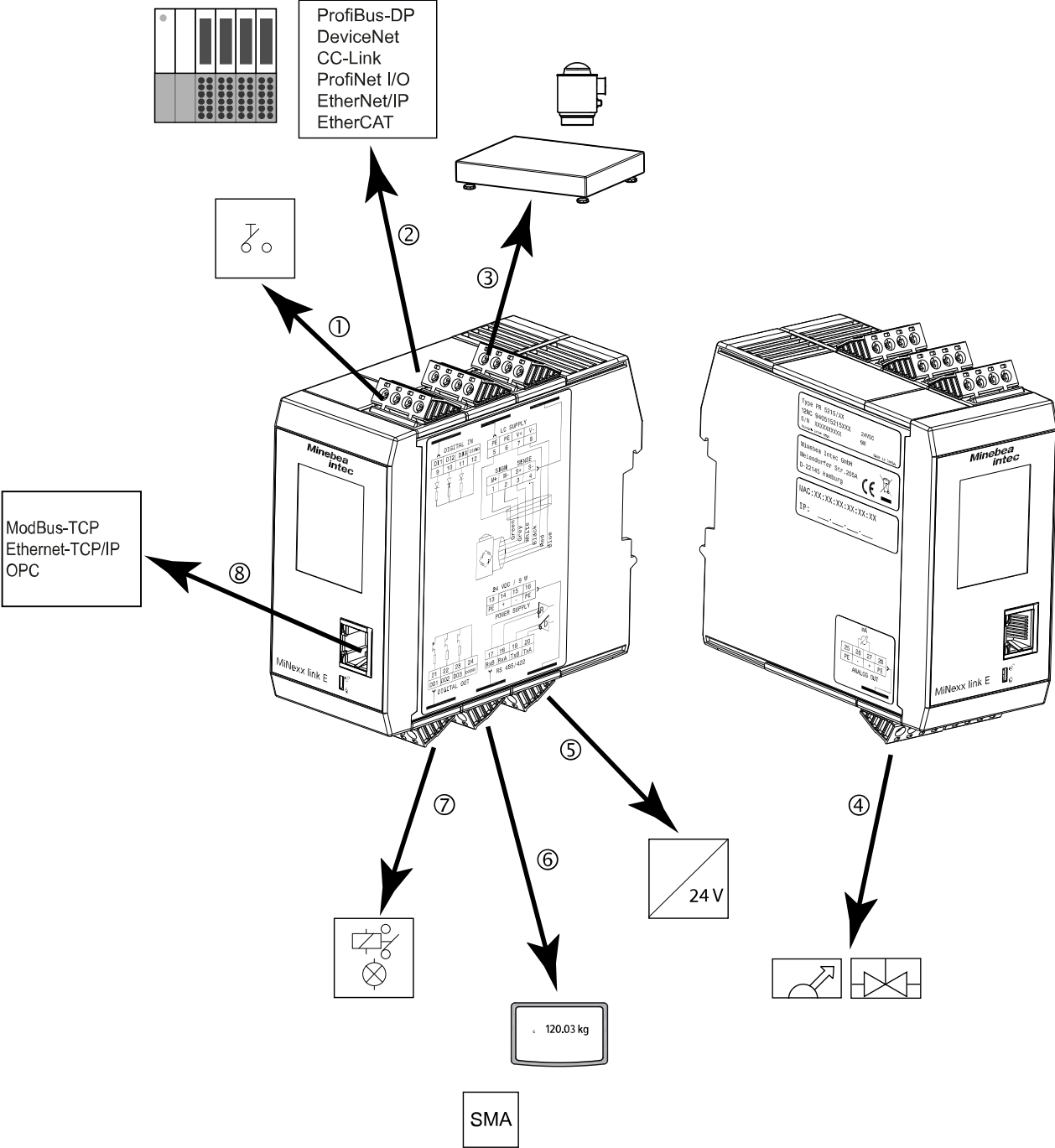

Pos.	Connection	Description
①	3 digital inputs	Contact inputs, for example, can be implemented. See Chapter Digital inputs for an example.
②	Fieldbus interface	The corresponding device (see Chapter Transmitter types) can be included under a communication master (e.g. Siemens S7 ProfiBus) as a field bus slave.
③	Analog weighing electronics	Analog weighing platforms and analog load cells can be connected (via a cable junction box).
④	1 analog output	The analog output can be used to control valves, for example.
⑤	Supply voltage connection	$U_{DC} = 24\text{ V}$
⑥	RS-485 interface	The following devices can be connected via the serial interface: <ul style="list-style-type: none"> - Remote display - PC via SMA protocol
⑦	3 digital outputs	Current or voltage inputs, for example, can be implemented. See Chapter Digital outputs (relay outputs) for an example.
⑧	Ethernet port	The Ethernet port is used for configuration of the device, ModBus-TCP, Ethernet-TCP/IP and OPC functionality.

3.3.4 Sticker

Connection diagram

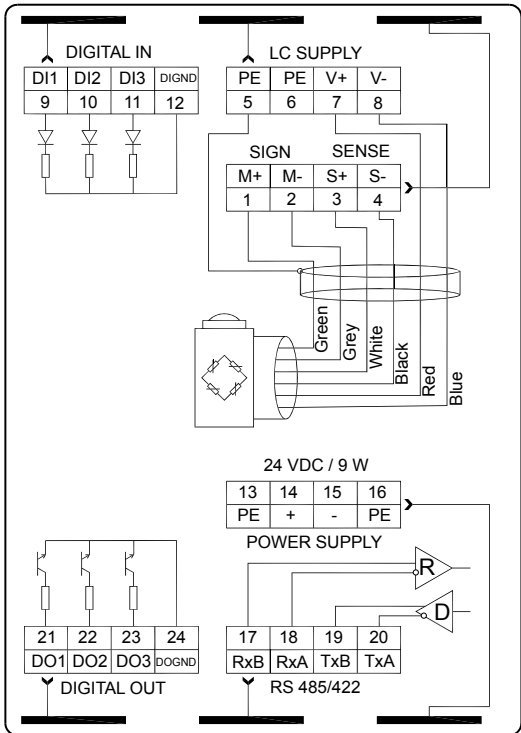

The connection diagram is located on the right side of the housing.

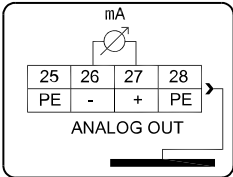

The connection diagram of the analog output is located on the left side of the housing.

Identification plate

Type PR 5215/XX
 12NC 9405 152 15XXX 24VDC
 S/N XXXXXXXXXX 9W
Minebea Intec GmbH Made in India

Minebea Intec GmbH
 Meiendorfer Str.205A
 D-22145 Hamburg

MAC : XX : XX : XX : XX : XX : XX
 IP : ____ . ____ . ____ . ____

The identification plate is located on the left side of the housing.

4 Device installation

4.1 General instructions

Before starting work, please read Chapter 2 and follow all instructions.

WARNING



Warning of hazardous area and/or personal injury

- ▶ Installation work must be performed by trained and qualified personnel who are aware of and able to deal with the related hazards and take suitable measures for self-protection.

WARNING



Warning of hazardous area and/or personal injury

- ▶ All cable connections must be protected from damage.

Note:

- Measurement cables should be kept away from power equipment.
- Signal cables and measurement cables should be installed separately from electric power lines.
- Measurement cables should be laid in separate cable conduits.
- Network cables should be crossed perpendicularly.

Further procedures:

- Check the consignment: make sure that all components are present.
- Safety check: inspect all components for damage.
- Make sure that the on-site installation is correct and complete including cables, e.g. power cable fuse protection, platform scale, load cells, junction box, data cables, console/cabinet, etc.
- Also mount plug-in cards where appropriate (instrument must be disconnected from all sources of power).
- Follow all device installation instructions related to application, safety, ventilation, sealing and environmental influences.
- Connect the cable from the junction box or platform scale/load cell.
- Connect additional data cables/network cables etc. as needed.
- Connect the supply voltage.
- Check the installation.

4.2 Mechanical preparation

4.2.1 Storage and transport conditions

NOTICE

Material damage is possible.

Unpacked devices may lose their precision due to strong vibrations; strong vibrations may impair the safety of the device.

- ▶ Do not subject the device to extreme temperatures, moisture, shocks, and vibrations.

4.2.1.1 Storage temperature

Storage temperature range: -20...+70 °C

4.2.1.2 Transport conditions

The packaging for transportation of Minebea Intec devices was designed to avoid transport damage. It is recommended that the box and all parts of the packaging should be kept for future storage or transportation of the device.

To avoid damage to the device, all cables must be removed before packaging it for transportation.

4.2.2 Installation location

Avoid unsuitable influences at the installation location:

- Extreme temperatures and excessive temperature fluctuations (see Chapter [Ambient conditions](#))
- Heat due to proximity to heaters or due to direct sunlight
- Aggressive chemical vapors
- Extreme moisture (see Chapter [Ambient conditions](#))
- Extreme vibrations (see Chapter [Ambient conditions](#))

4.2.3 Unpacking

- ▶ Unpack the device and check it for visible external damage.
 - ▷ If there is damage, follow the instructions in Chapter [Safety inspection](#).
- ▶ Keep the original packaging in case the device needs to be returned. Remove all cables before sending.

4.2.4 Checking the equipment supplied

- Transmitter
- Safety instructions

4.2.5 Acclimatizing the device

If a cold device is brought into a warm environment, condensation may form.

- ▶ Keep the device disconnected from the mains and allow it to acclimatize at room temperature for approx. two hours.

4.2.6 cable connection

Have all required parts, technical documents and tools at hand for control cabinet installation.

Other procedure:

- Install the mounting rail (35 mm) in the switch cabinet with rail connector, screen clamping rail and screen clamp.
- Install the device.
- Secure the cable at the place of installation, e.g. using cable ties.
- Remove the insulation from the cable ends and keep the strands short.
- Connect the screens to the screen clamping rail using screen terminals; see Chapter [EMC-compliant installation](#).

4.2.7 EMC-compliant installation

4.2.7.1 Connecting the screens and the equipotential bonding conductor

- Only use screened data cables.
- Connect screens to ground on both sides.
- Keep unscreened cable ends short.

- Establish a low-resistance connection between the screen clamping rail and the cabinet/housing.
- Use a metallic or metalized connector housing.
- Establish equipotential bonding between devices/system components (this is essential for Ex applications).
- Use a standardized reference potential.
- Connect the mounting rail to protective ground.
- Keep measurement and data cables away from power cables.

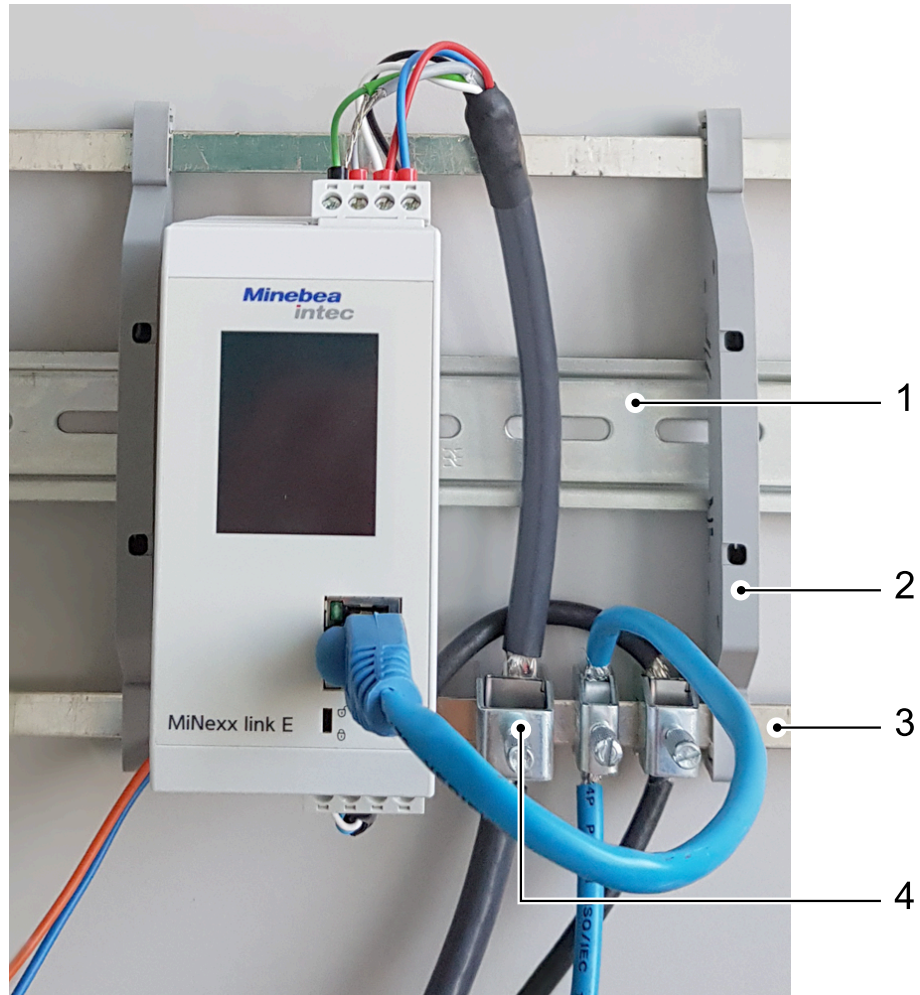

Pos.	Name
1	Mounting rail (35 mm)
2	Rail connector (e.g. Phoenix AB-SK 65D)
3	Screen clamping rail (e.g. Phoenix NLS-CU 3/10)
4	Screen clamp (e.g. Phoenix SK8-D)

4.3 Hardware construction

4.3.1 Network port

The device has an internal Ethernet port.

NOTICE

Damaged data will bring a stop to IT operations.

Protect the IT network to prevent unauthorized access.

- ▶ The current IT security guidelines must be followed so as to minimize the risks.

4.3.1.1 Ethernet port

The Ethernet port contains a powerful TCP/IP interface connection with transfer rates of 10 or 100 Mbit/s.

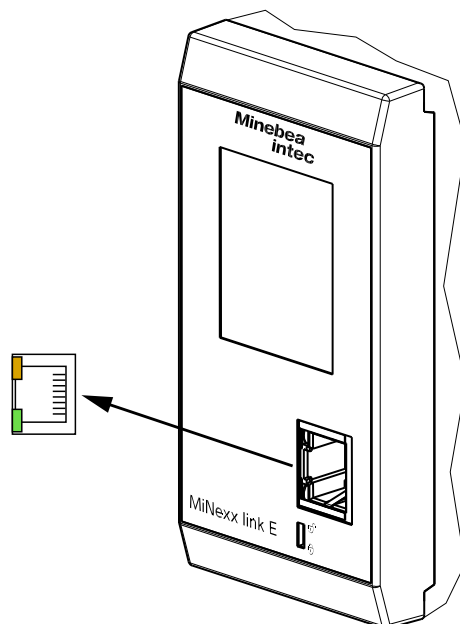

Technical data

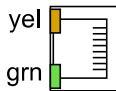
Description	Data
Connection 	RJ-45 plug connector (female) on the device front yellow (yel): lights up when there is an existing connection (link) green (grn): flashing on data traffic (activity)

Technical data (continued)

Description	Data
Transfer rate	10 Mbit/s, 100 Mbit/s, full/half duplex, auto-detection
Default IP address	192.198.0.100, DHCP is switched on
Subnet Mask	255.255.255.0
Connection mode	Point to point
Potential isolation	yes
Cable type	CAT 5 patch cable, twisted pair, screened
Cable impedance	150 Ω
Cable length	max. 115 m

4.3.2 RS-485 interface

The device is equipped with an integrated RS-485 interface. The interface can be configured by software.

The connection diagram is located on the right side of the housing.

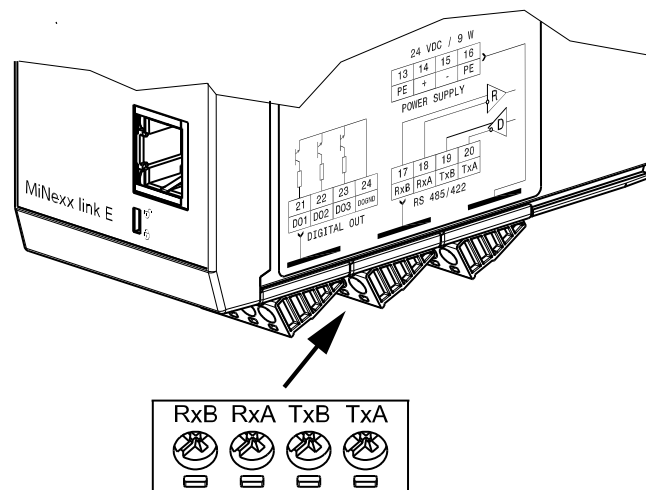
**Technical data**

Description	Data
External Connection	4-pin plug connector
Number of channels	1
Type	RS-485, full duplex
Transfer rate [Bit/s]	300, 600, 1200, 2400, 4800, <9600>, 19200

Technical data (continued)

Description	Data
Bits/Stop bit	Remote display: <7/1> SMA protocol: <8/1> Modbus-RTU protocol: <8/1>
Parity	Remote display: <even> SMA protocol: <none> Modbus-RTU protocol: <none>
Signals	TxA, RxA (R-), TxB, RxB (R+)
Potential isolation	yes
Cable type	Twisted pair, screened (e.g., LifYCY 2x2x0.20) 1 pair of wires for ground (GND).
Cable gauge	1.5 mm ²
Cable length	max. 1000 m

<...> = preset values (factory settings)

4.3.3 Digital inputs

3 passive opto-decoupled inputs are permanently built into the device. The interface can be configured by software.

The connection diagram is located on the right side of the housing.

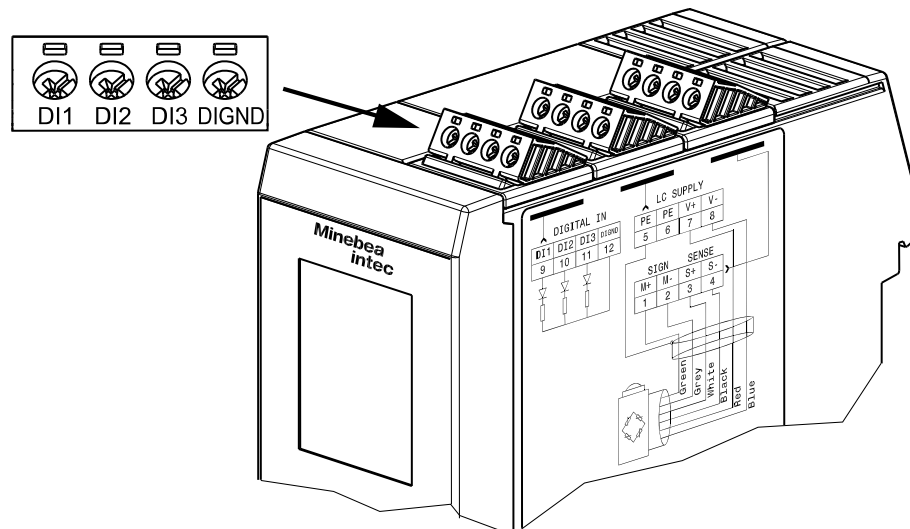

Technical data

Description	Data
External connection	4-pin plug connector
Number of inputs	3 (DI1, DI2, DI3)
Input voltage	Low: $U_{DC} = 0...5\text{ V}$ High: $U_{DC} = 10...30\text{ V}$ Passive: external power supply required
Input current	<11 mA @ $U_{DC} = 24\text{ V}$ <5 mA @ $U_{DC} = 12\text{ V}$
Signals	DIGND (-) common for all inputs
Potential isolation	yes, via optocoupler
Cable length	max. 50 m, screened

Example:

Contact input

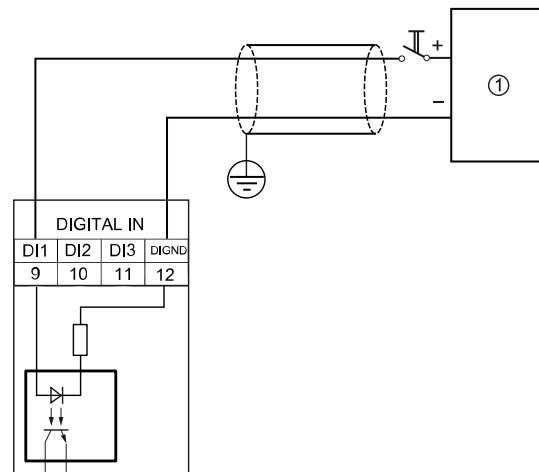
① Supply unit $U_{DC} = 24\text{ V } 0.5\text{ A}$

If the voltage at terminals (in this example: DI1-DIGND) is $U_{DC} = 10\text{ V}$, input DI1 is active (true).

4.3.4 Digital outputs (relay outputs)

3 passive opto-decoupled outputs are permanently built into the device. The interface can be configured by software.

The connection diagram is located on the right side of the housing.

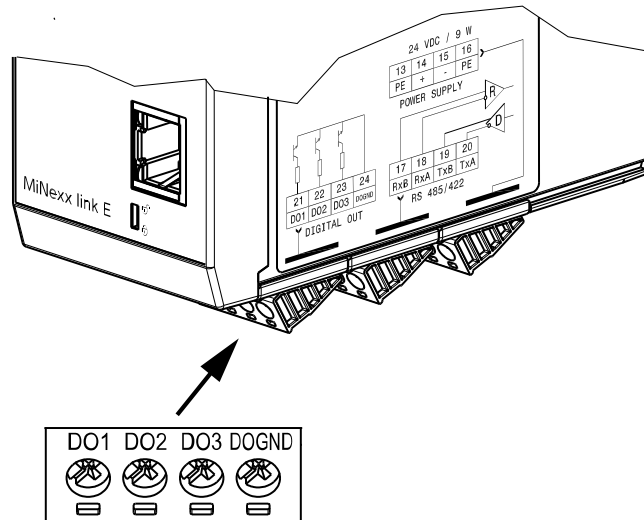

Technical data

Description	Data
External connection	4-pin plug connector
Number of outputs	3 (DO1, DO2, DO3)
Supply voltage	max. 30 V external
Switching current	max. 30 mA
Signals	DOGND (-) common for all outputs
Potential isolation	yes, via optocoupler
Cable length	max. 50 m, screened

Example:

Relay control (power output)

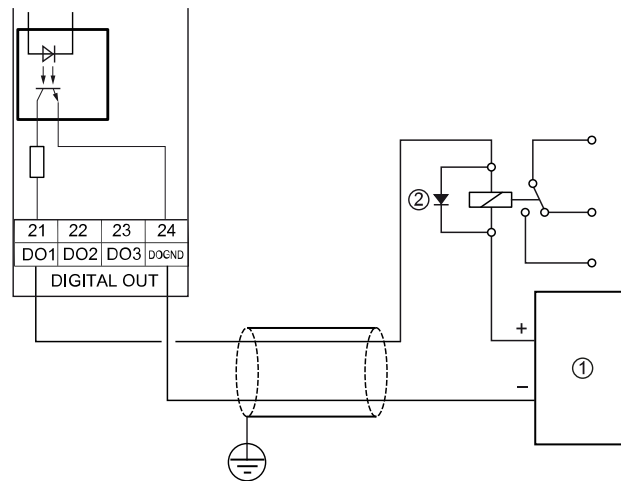

① Supply unit $U_{DC} = 24\text{ V } 0.5\text{ A}$

② Inductive load for free-wheel diode

The relay switches when the output DO1 is active (true).

To protect the output circuit, relays must be equipped with free-wheel diodes.

Example:

Voltage output

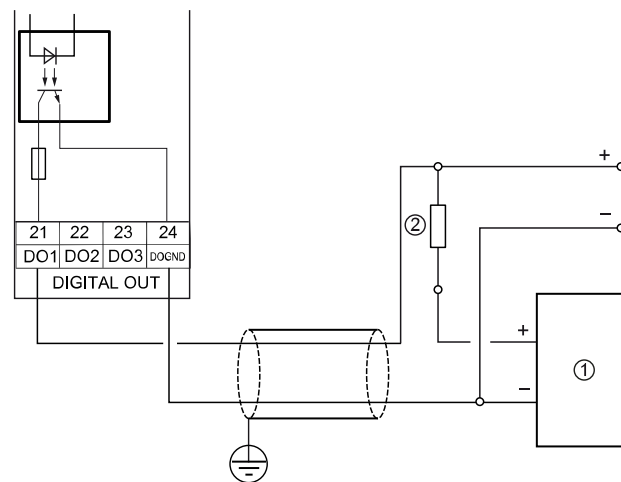

① Supply unit $U_{DC} = 24\text{ V } 0.5\text{ A}$

When the output DO1 is active (true), the output voltage drops from $U_{DC} = 24\text{ V}$ to $U_{DC} < 3\text{ V}$.

② The load resistance must be $2.2/1\text{ k}\Omega$.

4.3.5 Connection of analog load cells and platforms

4.3.5.1 General instructions

The device is equipped with an integrated connection for analog weighing electronics. The interface can be configured by software.

The connection diagram is located on the right side of the housing.

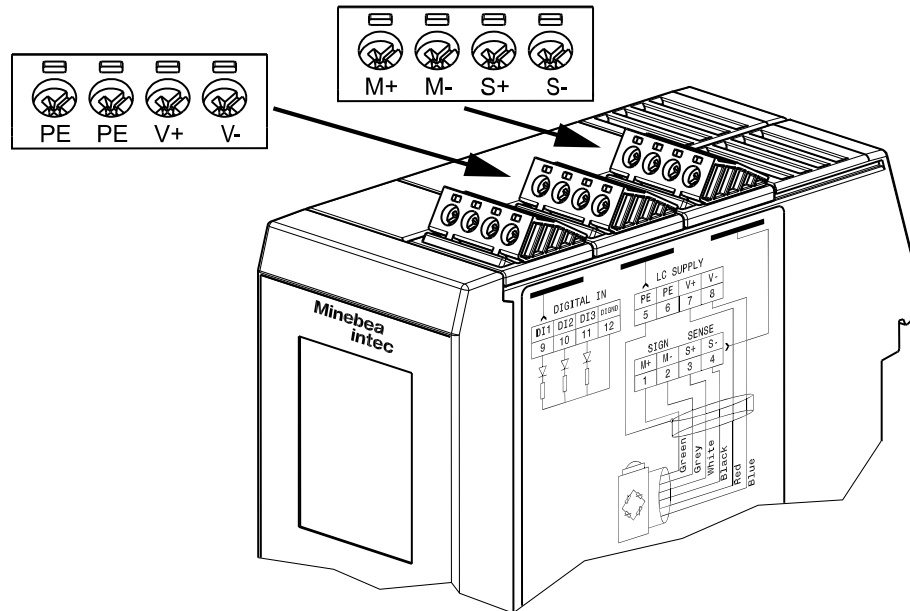

The supply voltage is protected against short circuit/overload.

Analog platforms can be connected to the device., see Chapter [Connecting an analog weighing platform with a 6-wire cable](#).

Load cells can be connected to the device as follows:

- One load cell directly, see Chapter [Connecting a load cell with a 4-wire cable](#) and [Connecting a load cell with a 6-wire cable](#)
- several load cells in the junction box via connecting cable, see Chapter- [Connecting between 2 and 8 load cells \(650 Ω\) using a 6-wire connection cable](#) and [Sticker](#)

Note: Do **not shorten** the load cell cable. Connect the prepared cable end and roll up the excess length.

Transmitter terminals

Terminal contact	Connection	Description	Color
M+	+ Meas.	+ Signal/LC output	green
M-	- Meas.	- Signal/LC output	gray
S+	+ Sense	+ Sense	white
S-	- Sense	- Sense	black
PE		Screen	
+	+ Supply	+ Supply/excitation	red
-	- Supply	- Supply/excitation	blue
PE		Screen	

Note:

The colors listed here apply for the Minebea Intec products.

Color code

bk = black

bu = blue

gn = green

gy = gray

rd = red

wh = white

For additional information on the connection, refer to the corresponding technical documentation.

4.3.5.2 Connecting an analog weighing platform with a 6-wire cable

Connection example

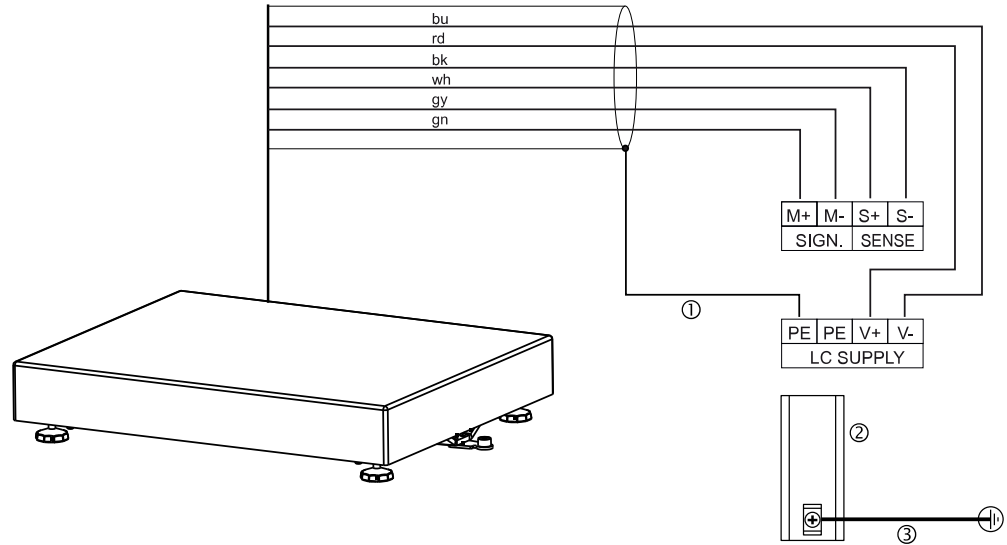

- ① Screen
- ② Mounting rail
- ③ Potential equalization

4.3.5.3 Connecting a load cell with a 4-wire cable

Connection example

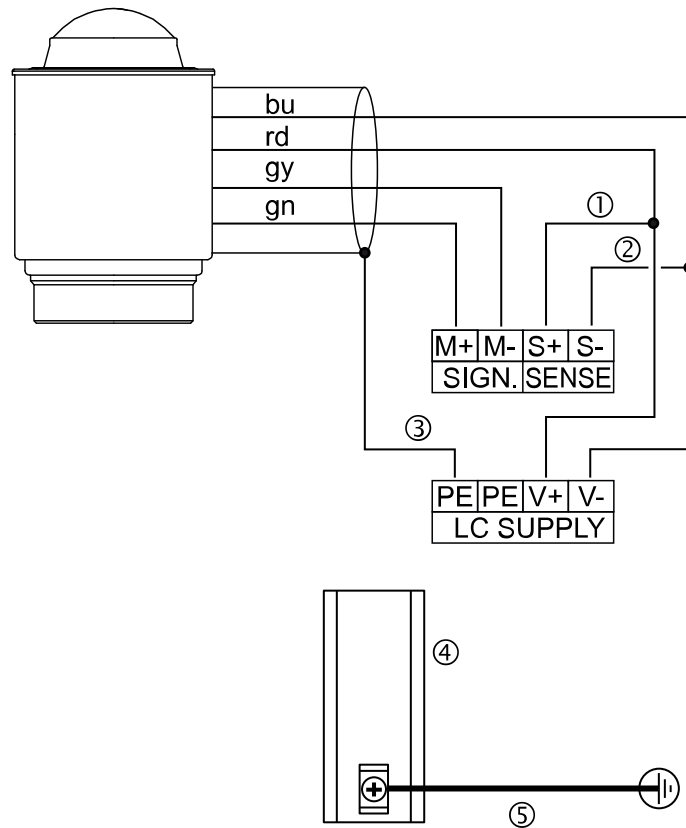

Provide the following links between the terminal contacts:

- ① from + Supply (+V) to + Sense (+S)
- ② from - Supply (-V) to - Sense (-S)

Further connections:

- ③ Screen
- ④ Mounting rail
- ⑤ Potential equalization

4.3.5.4 Connecting a load cell with a 6-wire cable

Connection example

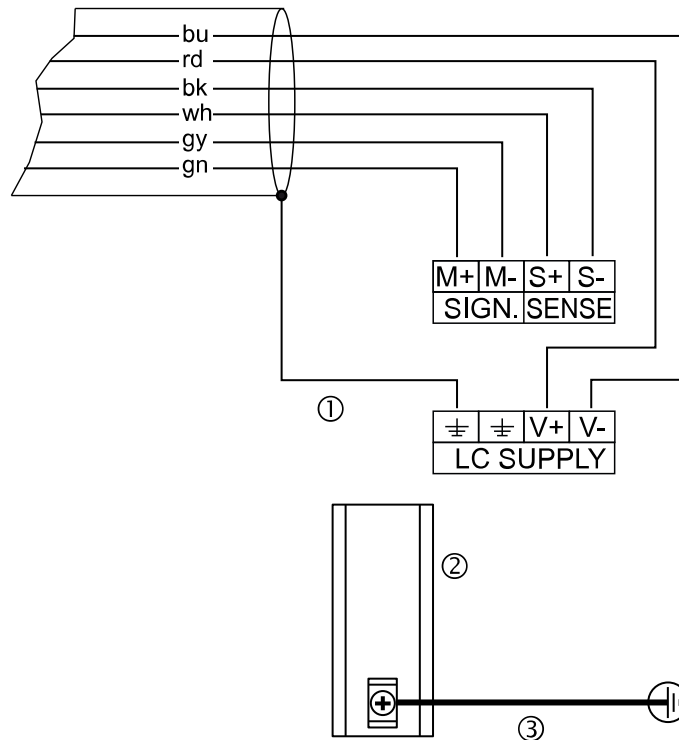

- ① Screen
- ③ Mounting rail
- ④ Potential equalization

4.3.5.5 Connecting between 2 and 8 load cells (650 Ω) using a 6-wire connection cable

Connections are made via cable junction box PR 6130/.. using connection cable PR 6135/.. or PR 6136/... .

Recommendation

- Install cable in steel pipe connected to a ground potential.
- The distance between the measuring cables and the power cables should be at least 1 m.

Load cell supply circuit

- Load resistance of load cell circuit $\geq 75 \Omega$, e.g., 8 load cells of 650 Ω each
- The supply voltage is fixed at $U_{DC} = 5 \text{ V}$ and protected against short circuits.

For further technical data, see Chapter [General technical data](#).

Note:

If hum interference occurs, the cable screens should only be connected on one side.

Depending on the design of the cable junction box used, either the jumper J3 must be removed or the cable screens must be disconnected from the terminal contacts highlighted in yellow.

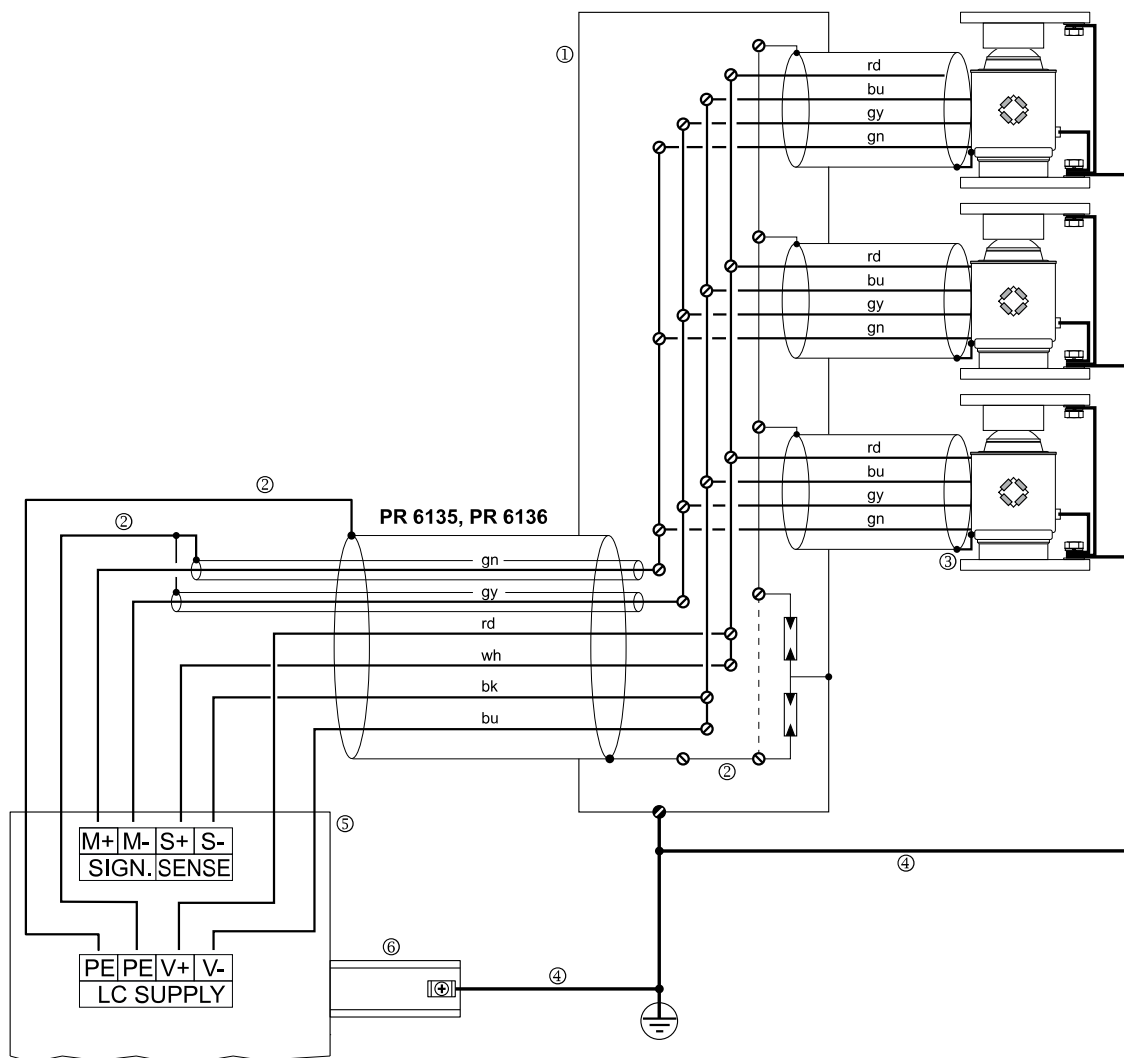
Connection example

- ① Cable junction box
- ② Screen
- ③ The cable screen is connected to the load cell housing.
- ④ Potential equalization
- ⑤ Transmitter
- ⑥ Mounting rail

4.3.5.6 Testing the measuring circuit

A simple test with the load cells connected can be carried out with a multimeter.

Note:

In the case of an external load cell supply voltage or use of an isolating unit, the internal load cell supply is not relevant.

Supply voltage

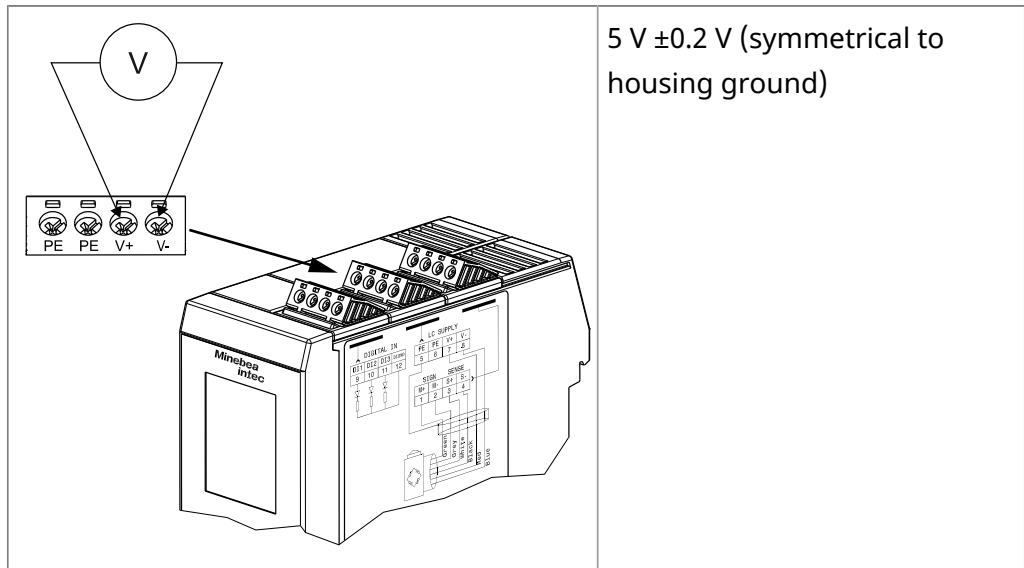

Sense voltage

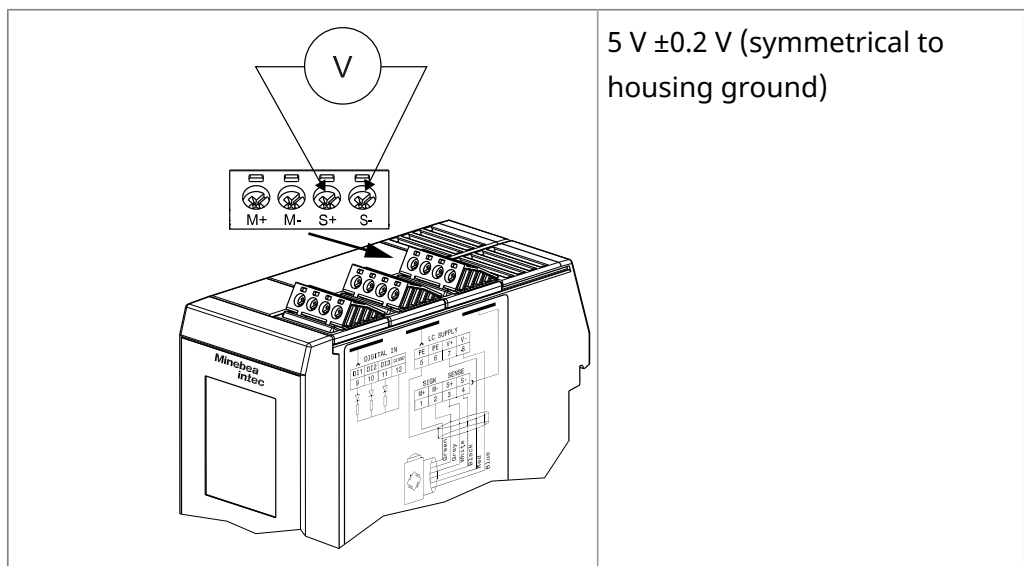

Measuring voltage

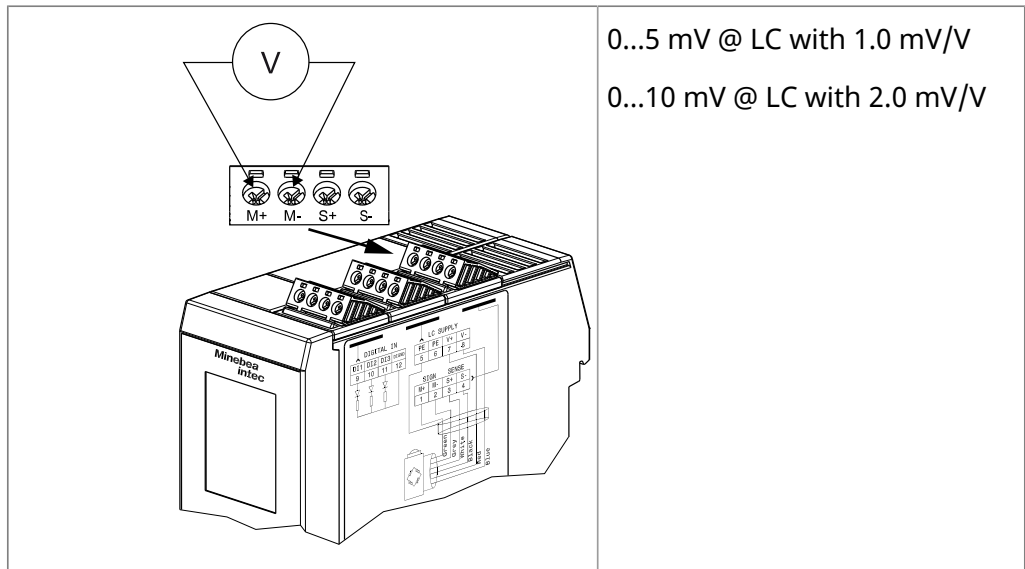

Measuring voltage

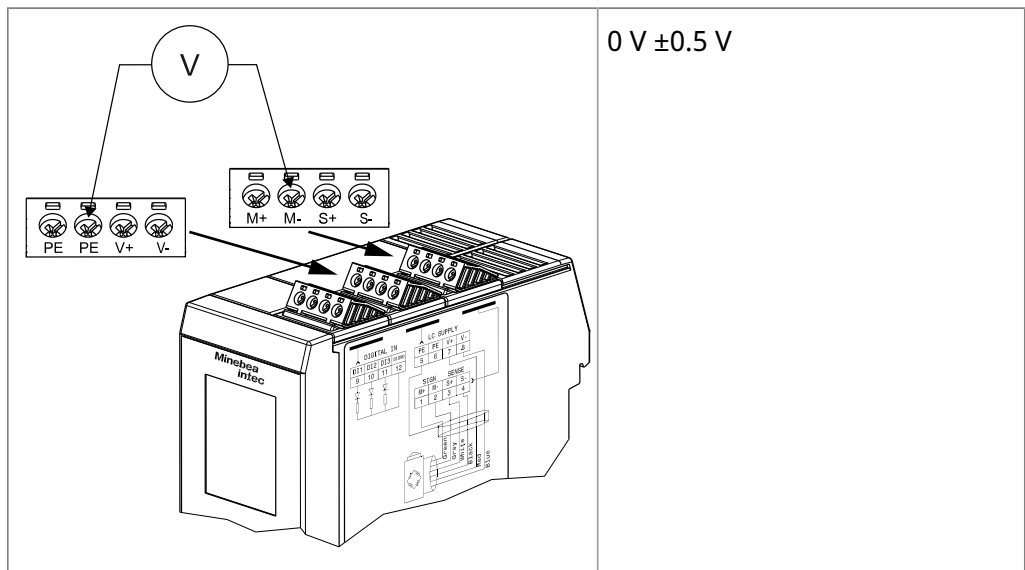

4.3.6 Analog output

An active analog output is integrated into the device. The interface can be configured by software.

The connection diagram is located on the left side of the housing.

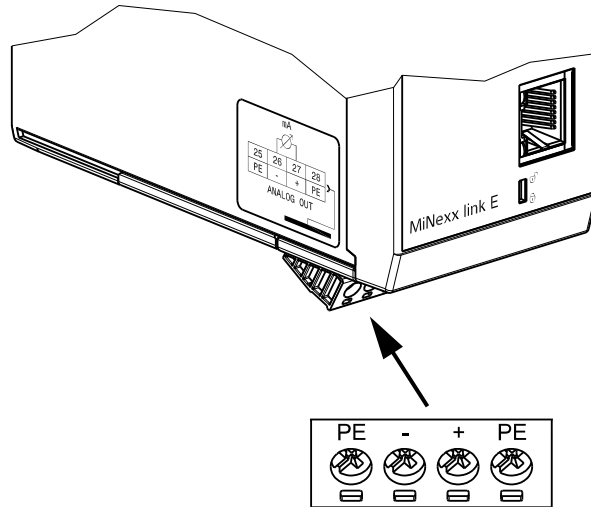

Technical data

Description	Data
External connection	4-pin plug connector
Number	1 active current output: 0/4-20 mA (max. 24 mA), 10 V output voltage via external 500 Ω resistor
Function	Gross/Net weight/Transparent/Selected, configurable
Range	0/4-20 mA, configurable
Resolution	e.g. 0-20 mA in max. 40,000 counts
Linearity error	@ 0-20 mA: 0.04 %; @ 4-20 mA: 0.02 %
Temperature error	<100 ppm/K
Zero point error	0.05 %
Max. error	<0.1 %
Load	max. 0...500 Ω
Protected against shortcircuit	yes
Potential isolation	yes

Technical data (continued)

Description	Data
Cable type	Twisted pair, screened (e.g., LifYCY 2×2×0.20)
Cable length	<150 m, screened

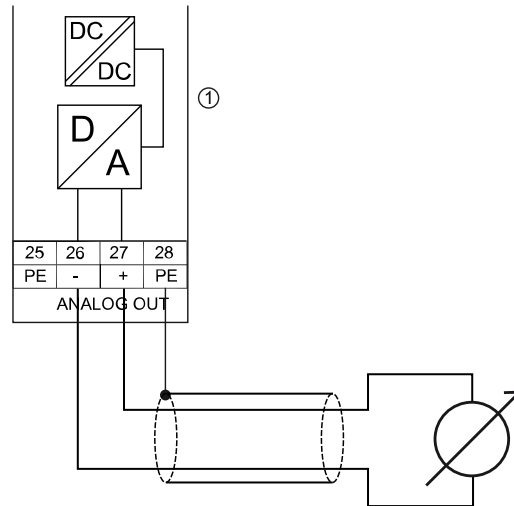
Analog signal "current output"

① 0/4-20 mA; $\leq 500 \Omega$

Current is supplied directly via the terminal contacts.

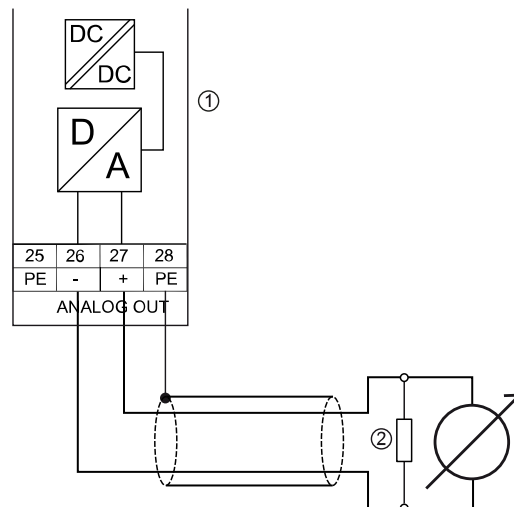
Analog signal "voltage output"

① 0-10 V; 500Ω

② The voltage level corresponds to the voltage drop at the external 500Ω resistor.

4.3.7 ProfiBus-DP interface

With the Profibus-DP a centrally directed data exchange between master and slaves is possible. The master (e.g. automation system PLC) carries out the cyclic exchange of process data with the slaves (drives, I/O) one after the other, in a fixed sequence.

Communication protocols and syntax comply with the Profibus-DP standard to IEC 61158.

The interface can be configured by software.

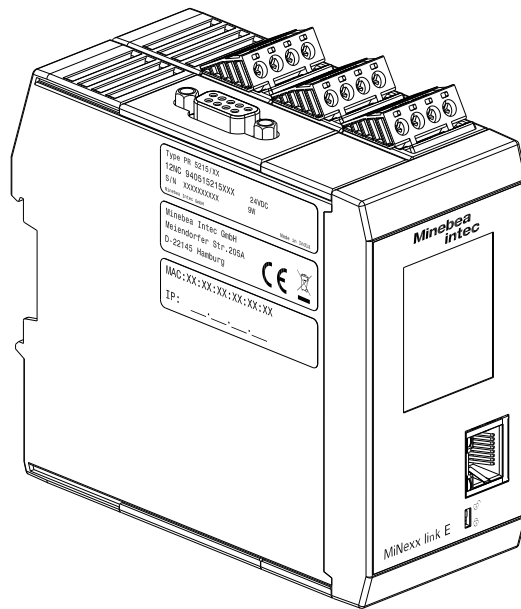

Technical data

Description	Data
External connection	D-Sub 9-pin plug connector (female)
Transfer rate	9.6 kbit/s to 12 Mbit/s, baud rate auto-detection
Connection mode	Profibus network, connections can be made/released without affecting other stations.
Protocol	PROFIBUS-DP-V0 SLAVE to IEC 61158
Configuration	GSD file "MINE5215.gsd"
Bus termination	The bus termination in the last device is implemented via the integrated terminating resistor in the Profibus plug connector.
Cable type	Profibus "special"; color: violet; screened twisted pair cable

Technical data (continued)

Description	Data
Cable impedance	150 Ω
Cable length	The max. distance of 200 m can be extended at 1.5 Mbit/s by means of an additional repeater.
Certificates	<p>PROFIBUS Nutzerorganisation e.V. grants to HMS Industrial Networks AB</p> <p>Certificate No: Z01951</p> <p>Model Name: Anybus CompactCom 40 PROFIBUS DP-V1</p> <p>Revision: 1.8; SW/FW: 1.08; HW: 1.0</p> <p>GSD: HMSA1815.GSD, File Version: 16-8-2019</p> <p>Test Report Number: PCN214-DPS-01</p>

Note: The GSD file is available to download online:

<http://www.minebea-intec.com>

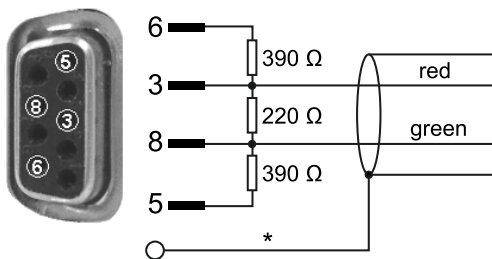
Profibus connection

The device is the only/last slave in the bus.

* screen on connector housing

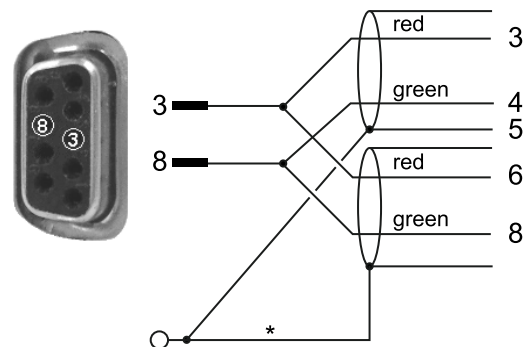

The device is not the only/last slave in the bus.

* screen on connector housing

Allocation of the D-sub 9-pin plug connector

Pin assignment	Signal	Color	Description
Housing	S		Screen
1			not connected
2			not connected
3	RxD/TxD-P (positive) according to RS-485 specification	red	Send/receive data Data core B/D (P)
4 if required	RTS		"Request To Send" (only when using a repeater)
5	DGND		Insulated GND to RS-485 side
6	VP		Insulated power supply +5 V to RS-485 side
7			not connected
8	RxD/TxD-N (negative) according to RS-485 specification	grün	Send/receive data Data core A/D (N)
9			not connected

Note:

Only plug connections with integrated terminating resistors may be used.
The terminating resistor must be turned on in the last slave.

4.3.8 DeviceNet interface

The DeviceNet fieldbus is a complete DeviceNet adapter (slave) with CAN controller.

The interface can be configured by software.

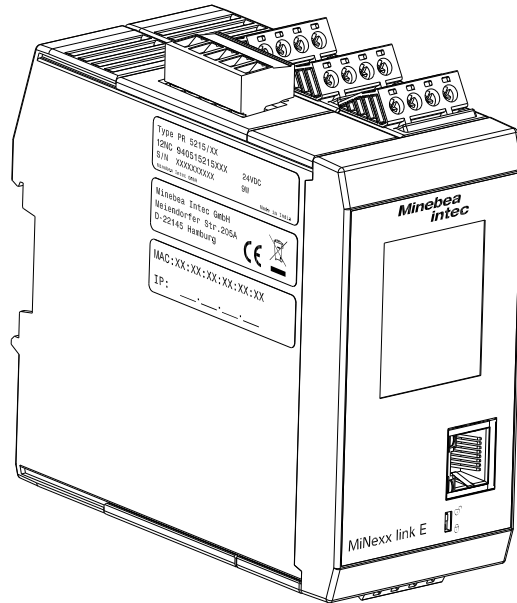

Technical data

Description	Data
External connection	5-pin plug connector (female)
Transfer rate	125, 250 and 500 kbit/s
Protocol	DeviceNet Master Slave <ul style="list-style-type: none"> - Polling procedure (polled IO) - CRC error recognition according to IEC 62026 (EN 50325) - Max. 64 station nodes - Data width max. 512 bytes "input & output"
Configuration	EDS file "MINE_5215.eds" MAC-ID (1...62)
Potential isolation	yes, optocoupler and DC/DC converter
Bus termination	120 Ω at the cable ends
Cable type	DeviceNet; color: petrol green; 2x2 twisted pair; screened
Cable impedance	150 Ω

Technical data (continued)

Description	Data
Cable length	Depends on cable type and transmission rate: 100 to 500 m
Certificates	<p>Test Information</p> <ul style="list-style-type: none"> - Vendor Name: HMS Industrial Networks AB - Composite Test Revision: CT25 - ODVA File Number: 11307.01 <p>Product Information</p> <ul style="list-style-type: none"> - Network Category: Node - Identity Object Instance - Vendor ID (Attribute 1): 90 - Device Type (Attribute 2): 0x2B - Device Profile: Name Generic Device (keyable) - Product Code (Attribute 3): 63 - Product Name (Attribute 7): CompactCom 40 DeviceNet™ - Product Revision (Attribute 4): 1.006 - SOC File Name: 7129_DeviceNet.stc

Note:

The EDS file is available to download online:

<http://www.minebea-intec.com>

Allocation of the 5-pin plug connector

Pin assignment	Signal	Color	Description
			
Cable sheath			Special DeviceNet cable (certified)
1	V-	black	negative power supply
2	CAN_L	blue	CAN_L bus signal
3	S		Cable screen
4	CAN_H	white	CAN_H bus signal
5	V+	red	positive power supply

4.3.9 CC-Link interface

The CC-Link fieldbus contains all functions to provide a complete CC-Link slave.

The interface can be configured by software.

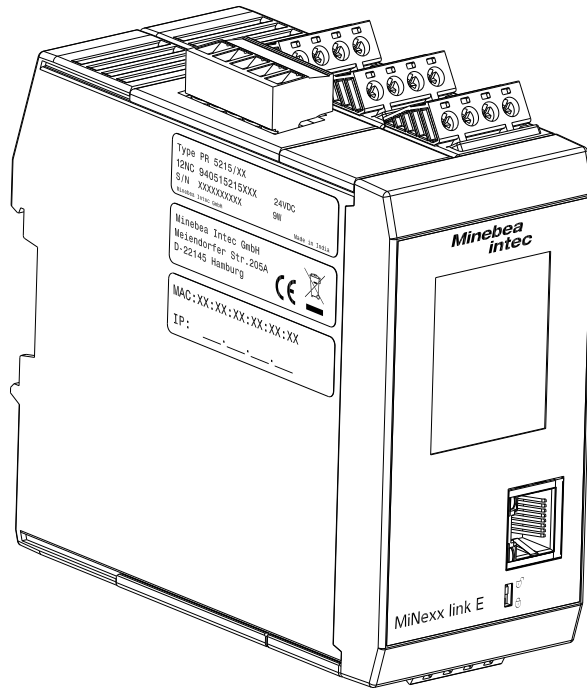

Technical data

Description	Data
External connection	5-pin plug connector (female)
Transfer rate	156; 625 kbps; 2,5; 5, 10 Mbps
Protocol	CC-Link Slave <ul style="list-style-type: none"> - CRC error recognition according to IEC 62026 (EN 50325) - Max. 64 station nodes - 128 I/O bits and 16 (32 bit) words
Configuration	CSPP-Datei "MINE_5215.cspp"
Potential isolation	yes, optocoupler and DC/DC converter
Bus termination	110 Ω at the cable ends
Bus load	100 mA
Cable type	2x2 twisted pair; screened

Technical data (continued)

Description	Data
Cable length	10 m @ 10 Mbps, 1200 m @ 156 kbps
Certificates	<ul style="list-style-type: none"> - Description of product: Anybus Compact Com 40 CC-Link - Type: ABCC-M40-CCL - Ver. : Hardware: 1.1, Software: 1.01 - CC-Link: 1.10/2.0 - Reference Number: 934

Note: The CSPP file is available to download online:
<http://www.minebea-intec.com>

Allocation of the 5-pin plug connector

Pin assignment	Signal	Description
		
1	DA	Communication RS-485 RxD/TxD (+)
2	DB	Communication RS-485 RxD/TxD (-)
3	GND	digital ground
4	S	Cable screen
5	PE, according to AnyBus S-specification	Housing ground

4.3.10 ProfiNet I/O interface

The ProfiNet I/O fieldbus is a complete ProfiNet I/O adapter (slave) with CAN controller.

The interface can be configured by software.

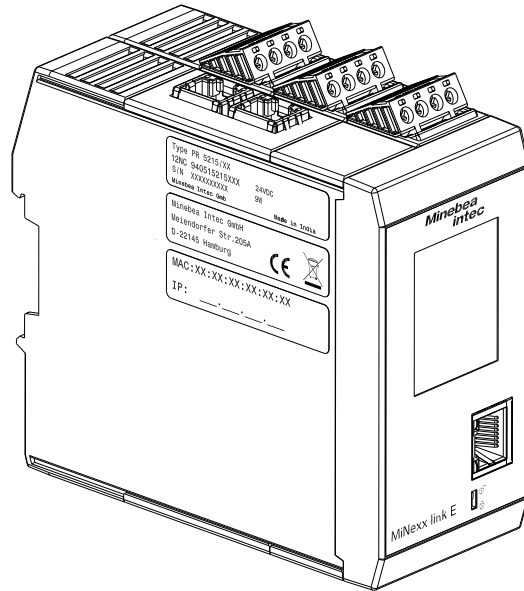

Technical data

Description	Data
External connection	2× RJ-45 plug connector (female)
Transfer rate	10 Mbit/s and 100 Mbit/s Auto-detection (10/100 Mbit/s half duplex/full duplex)
Protocol	ProfiNet I/O
Connection mode	Network
Configuration	XML file "GSDML-Vx.xx-Minebea-PR5215-2-Port-xxxxxx.xml"
Potential isolation	yes
Cable type	Twisted pairs, screened, e.g., patch cable CAT5 Autolink (straight or crossover)
Cable impedance	150 Ω
Cable length to HUB	max. 115 m
Certificate	<ul style="list-style-type: none"> - Report: PN005-1, 12.02.2007; - Certificate no.: Z10931 - Model Name: Anybus CompactCom 40 PIR-PROFINET-IRT - Revision: SW/FW:V1.50.01; HW: 2 - Identnumber: 0x010C; 0x0010 - DAP: DAP 1, 0x80010000

Note:

The XML file is available to download online:

<http://www.minebea-intec.com>

NOTICE**Fieldbus parameters**

Recommendation for a Siemens S7, for example

- ▶ Fieldbus slave setting:
- ▶ Use DHCP [on] as per the default settings and activate the master as a DHCP server (W [Allocate IP adr via IO controller]).

NOTICE**Slave - master device names**

A unique device name must be assigned out of the master. This name is given highest priority when establishing a connection.

- ▶ When replacing devices or servicing, please note:
- ▶ As well as the IP address, the device name must correspond to that of the replacement device. Explicit assignment out of the master is required.

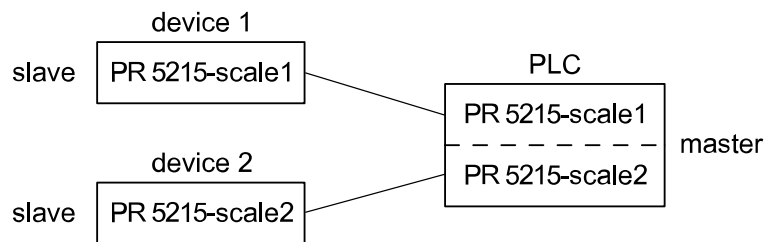
Example:**4.3.11 EtherNet/IP interface**

The EtherNet/IP fieldbus is a complete EtherNet/IP adapter (slave) for network connection.

The interface can be configured by software.

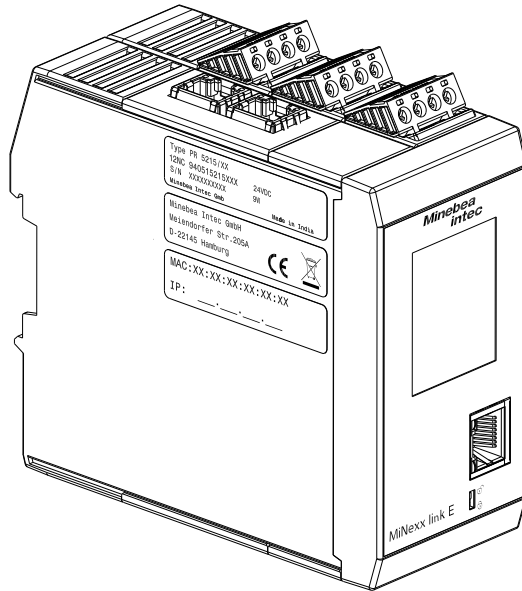

Technische Daten

Bezeichnung	Daten
External connection	2× RJ-45 plug connector (female)
Transfer rate	10 Mbit/s and 100 Mbit/s Auto-detection (10/100 Mbit/s half duplex/full duplex)
Protocol	EtherNet/IP
Connection mode	Network
Configuration	EDS file "min_5215_ethernetip.eds"
Potential isolation	yes
Cable type	Twisted pairs, screened, e.g., patch cable CAT5 Autolink (straight or crossover)
Cable impedance	150 Ω
Cable length to HUB	max. 115 m
Certificate	ODVA for HMS Industrial Networks AB EtherNet IP specification <ul style="list-style-type: none"> - ODVA file no. 11270.02 - Test date: June 17, 2016 - Vendor ID 90 - Product code: 55 - Product name: CompactCom 40 EtherNet/IP

Note:

The EDS file is available to download online:

<http://www.minebea-intec.com>

4.3.12 EtherCAT interface

The EtherCAT fieldbus is a complete EtherCAT adapter (slave) for the network connection with full duplex features of 100BASE-TX. These are fully utilized so that effective data rates of almost 200 MBit/s can be achieved.

EtherCAT is an open technology that is standardized in IEC 61158 and IEC 61784 as well as in ISO 15745-4.

The interface can be configured by software.

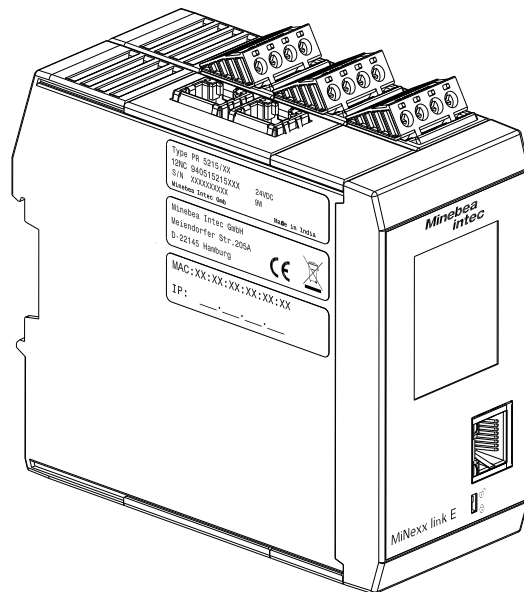

Technical data

Description	Data
External connection	2× RJ-45 plug connector (female)
Transfer rate	approx. 200 MBit/s Full duplex
Protocol	EtherCAT Cyclic transmission of I/O data Acyclic transmission of data such as parameters, diagnostics, device identification
Connection mode	Network
Configuration	EDS file "min_5215_EtherCAT-2Port.xml"

Technical data (continued)

Description	Data
Potential isolation	yes
Cable type	Twisted pairs, screened, e.g., patch cable CAT5 Autolink (straight or crossover)
Cable impedance	150 Ω
Cable length to HUB	max. 115 m
Certificate	<ul style="list-style-type: none"> - Product Name: Anybus CompactCom 40 Ether-CAT - Product Code: 0x36 - Revision Number: 0x20009 - Secondary Vendor ID: 0xE000001B - Test Report Number: 0x1B_004

Note:

The EDS file is available to download online:

<http://www.minebea-intec.com>

5 Getting started

5.1 Switching on the device

The device is started up via a notebook/PC using an Internet browser.

Note:

The following steps must be followed when connecting the device to mains voltage for the first time:

- Assign password, see Chapter [Assign password](#)
- Set the date and time, see Chapter [Current date & time](#).
- Set up the network (only necessary if the device is to be used or configured in the network), see Chapter [Connect device to the network](#).

5.2 Switching off the device

The device is switched off by disconnecting the supply voltage (24 V) or by loosening the plug connector.

5.3 Device warm-up time

A warm-up time of 30 minutes for the device is required before adjustment/calibration is started.

5.4 Power failure

In the event of a power failure, all entered configuration, adjustment and calibration parameters are retained.

5.5 Connect device to the network

5.5.1 Connecting device to the network via DHCP

How to connect the device to the network?

Note:

Factory setting of the device: "Use DHCP" is switched on.

Requirements:

- DHCP server of the network is active.
- Notebook/PC is switched on and connected to the network.
- The device is switched on.

1. Connect the device to the network via network cable.
2. Show the IP address (factory setting) on the display under [View settings] → [Interfaces] → [Network]
3. Open a WEB browser on the notebook/PC and enter the IP address in the input field of the WEB browser and confirm.

Note: If DHCP is switched on by default, it does not need to be activated separately.

- ▷ The login window of the device appears.
4. Assign password or enter existing one and click [Login].
 - ▷ The menu window appears.

5.5.2 Connecting device to the network via static IP address

How to connect device to the network via static IP address?

Note:

Factory setting of the device: "Use DHCP" is switched on.

Note:

A direct connection between device and notebook/PC is also possible if "Use DHCP" is switched on. The device uses the last IP or the default IP if it does not receive an IP from a DHCP server. Connecting the device is described below.

Requirements:

- Notebook/PC is switched on and connected to the network.
 - The device is switched on.
1. Connect the device to the network via network cable.
 2. Show the IP address (factory setting) on the display in the [Network] menu.

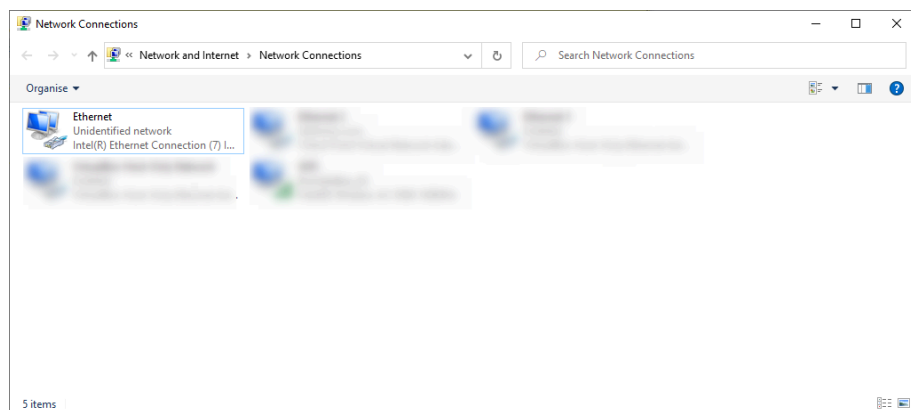

3. On the notebook/PC, open [Control Panel] → [Network and Internet] → [Network Connections].
4. Right-click on [Ethernet] and left-click on [Properties].
 - ▷ A window appears.

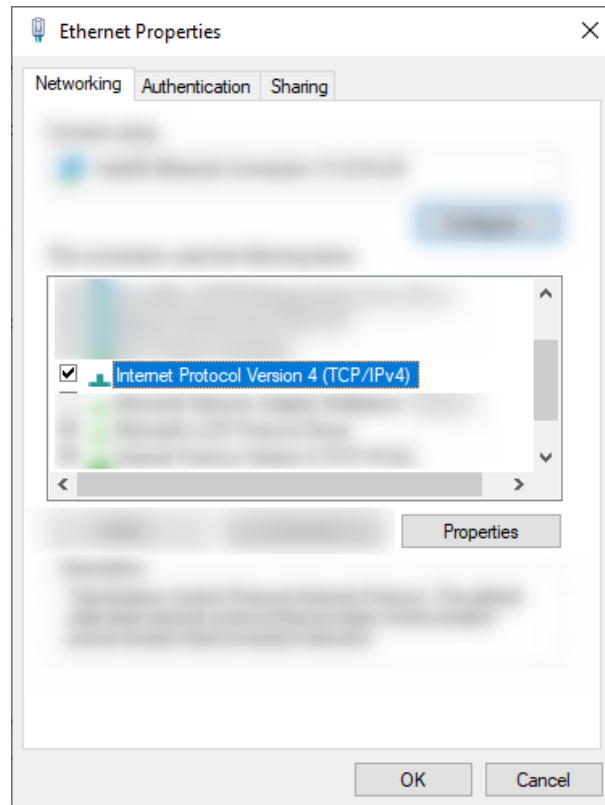

5. Under [Networking] select the protocol shown and click [Properties].

▷ A window appears.

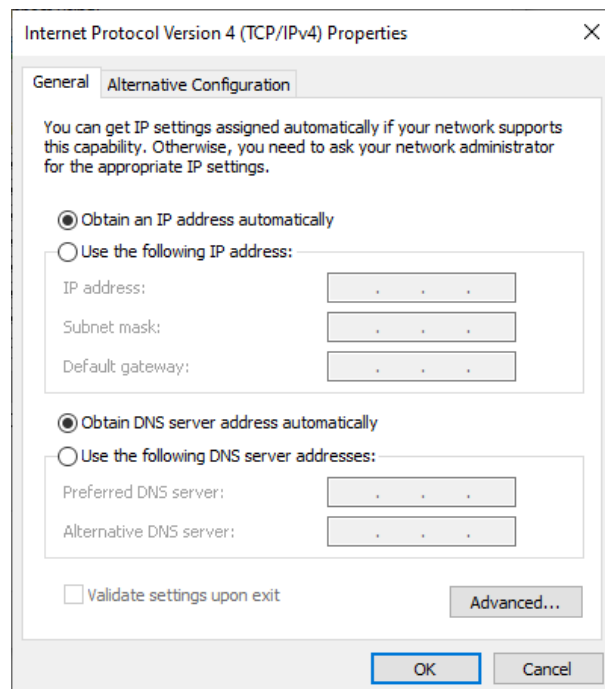

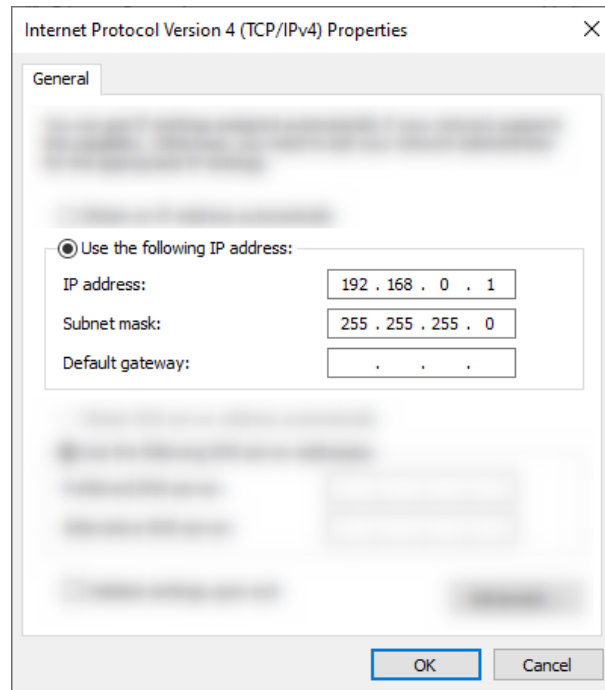

6. Select [Use the following IP address:].
7. Enter the same IP address as PR 5215 (see display), only the 4th byte must be different.

Example:

PR 5215: 192.168.0.100

Notebook/PC: 192.168.0.1

8. Enter the same subnet mask as PR 5215 (see display).
9. Confirm the selection with [OK].
10. Open a WEB browser on the notebook/PC and enter the IP address in the input field of the WEB browser and confirm.
 - ▷ The login window of the device appears.
11. Assign password or enter existing one and click [Login].

Note: If [View only mode] is clicked, the parameters are only displayed. It is not possible to change the parameters.

- ▷ The menu window appears.

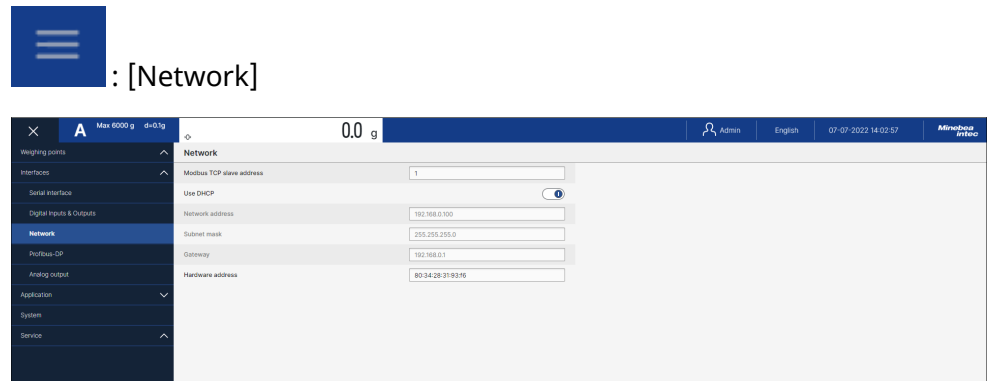

12. If necessary, make further settings in consultation with the responsible system administrator.
13. Save the settings.

5.6 Data backup

Additional overwrite protection is provided for adjustment/calibration data and parameters (see Chapter [CAL switch](#)).



5.7 Overwrite protection

5.7.1 CAL switch

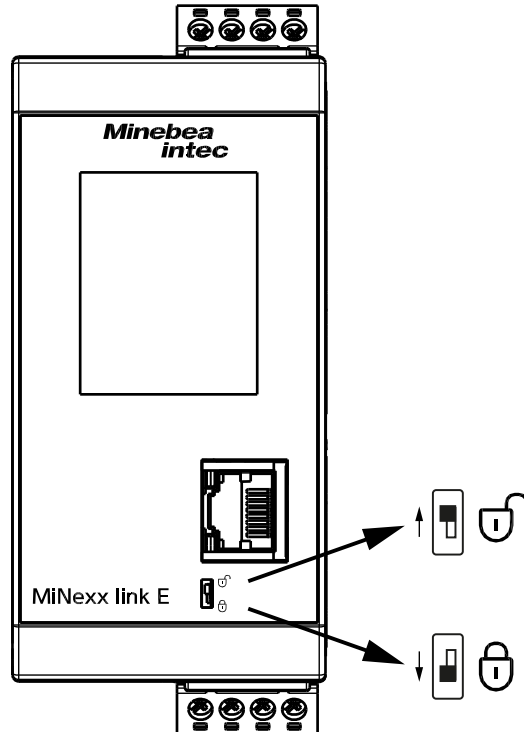
Overwrite protection can be activated via a CAL switch to protect the metrological parameters against unauthorized access.



The CAL switch is located on the front of the device.

Write protection not activated	Write protection activated
 opened	 closed
Changes to the metrological parameters can be carried out.	Blocks changes to the following metrological parameters: <ul style="list-style-type: none"> - Weighing ranges/parameters - Calibrate/adjust

The CAL switch can be protected by the customer with a suitable sticker.

5.8 Performing a factory reset on the device

Note:

A factory reset can only be performed if the CAL switch is open. The IP address and the host name are not affected by this.

Restarting has the following effects on the device

- Current process steps are deleted.
- The factory default settings are restored.



: [Service]

1. Click [More functions] → [Backup/Restore/Factory reset].

▷ A selection window appears.

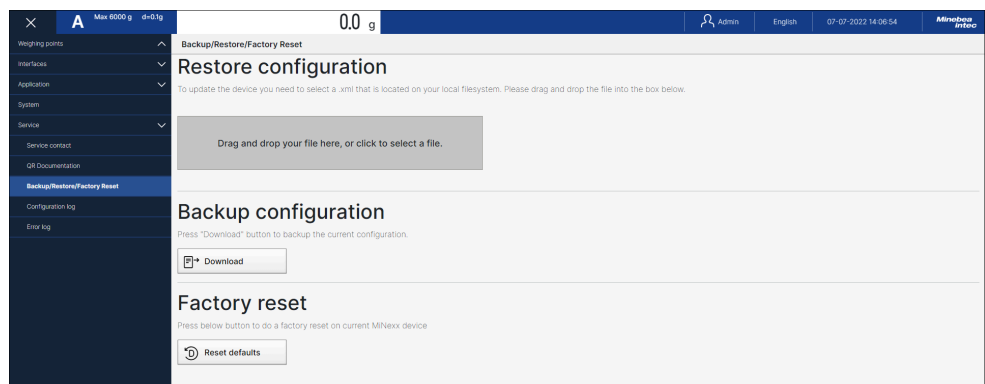

2. Under "Factory reset" click the [Reset] button.

▷ A message dialog appears.

3. Click [Save parameters].

4. Click [Ok] to finally restore the device to the factory settings.

6 Operating

6.1 Operating and display elements

6.1.1 TFT Color touch display

The color display is a touchscreen and consists of keys and displays.

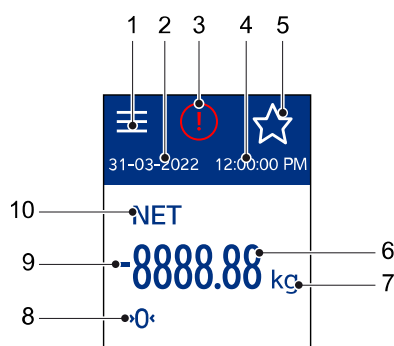

Pos.	Name
1	Menu button
2	Current date
3	Icon for warning and status displays
4	Current time
5	Key for switching views
6	Weight value (6 digits + decimal point)
7	Weight unit (t, kg, g, lb)
8	The gross weight value is within $\pm\frac{1}{4}$ d of zero
9	Positive/negative weight value
10	Weight type (NET = net)

6.1.2 WEB display

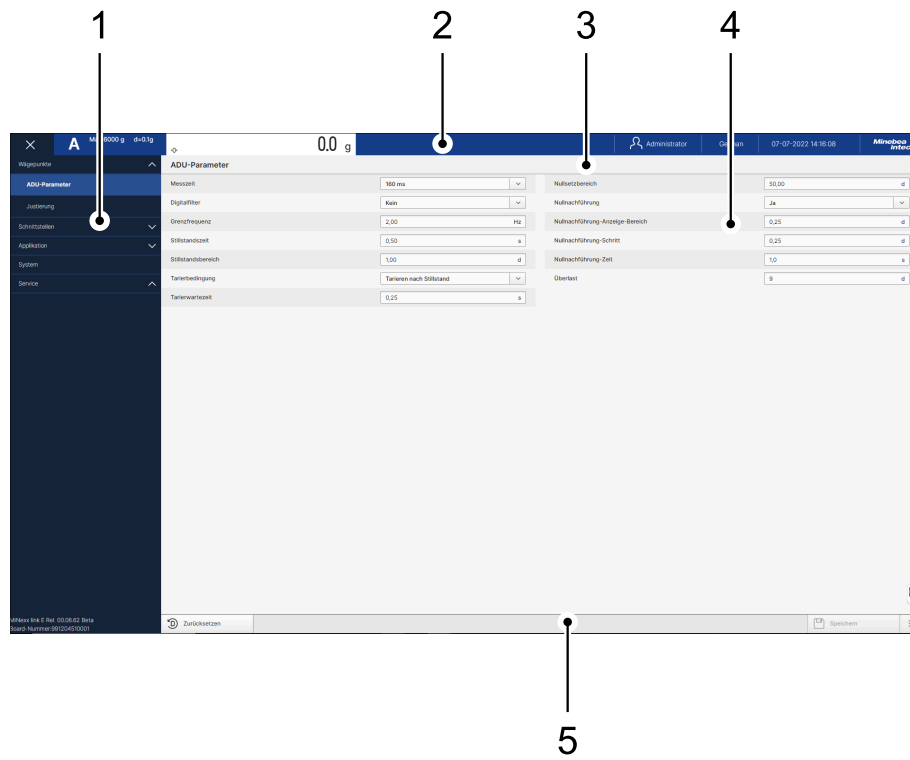

The display consists of various areas.

Pos.	Name
1	Menu selection
2	Header
3	Info line
4	Info pane
5	Taskbar

6.1.2.1 Menu selection

After logging in, the website appears with the menu selection hidden.

By clicking  the menu selection is displayed.

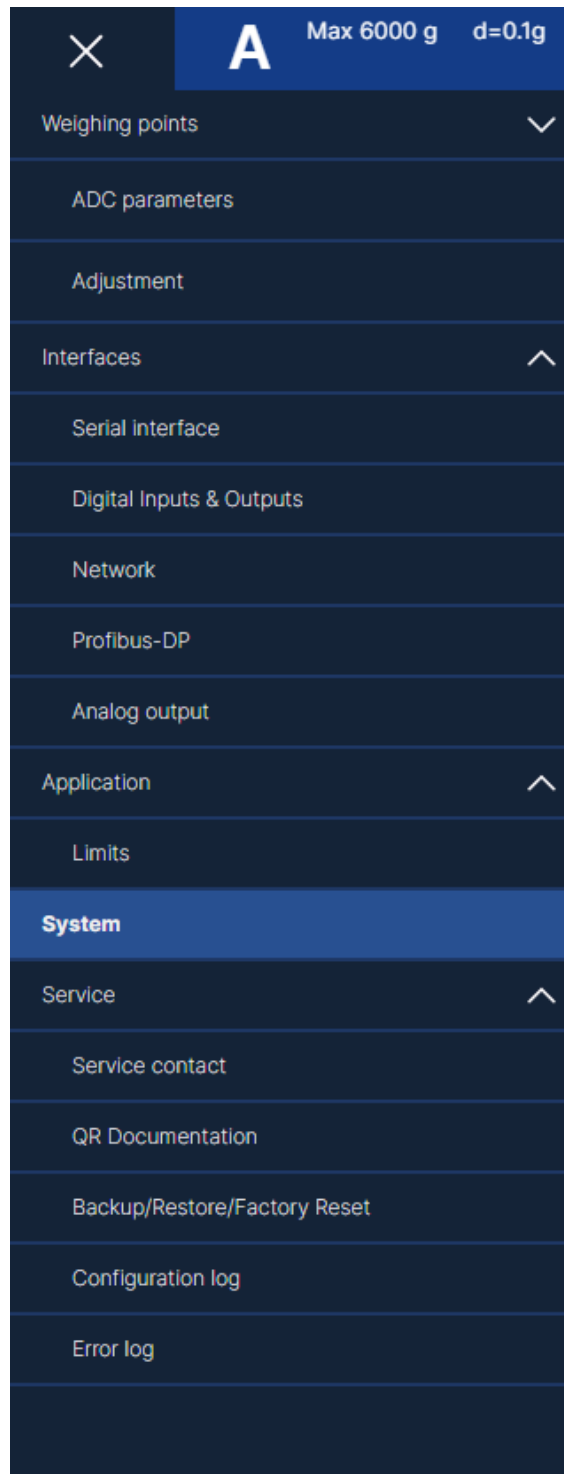

By clicking on the individual menu items, the corresponding view appears.



6.1.2.2 Header



The header contains the following areas:

- Display/hidden menu selection
- Weighing point/metrology
- Login status
- Operating language
- Date and time

Menu selection

Icon	Description
	Display menu selection
	Hide menu selection

Weighing point area/metrology

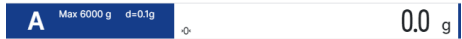
View	Description
	Displays the weighing point and metrology information and the current weight.

Login status

View	Description
	Displays login with password. Selection: Change password, Logout

Operating language

View	Description
	Displays the selected operating language.

Date and time

View	Description
	Displays the set date and time.

6.1.2.3 Information line



The information line shows the user the current menu position during operation.

6.1.2.4 Info pane

The window shows one of the following views at a time:

- Parameter lists
- Input and dialog windows

6.1.2.5 Taskbar

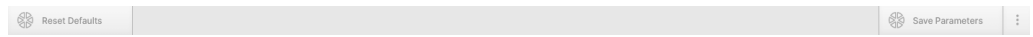

There are changing buttons in the taskbar.

Disabled buttons have a gray font.

6.1.3 Message dialog

Example:

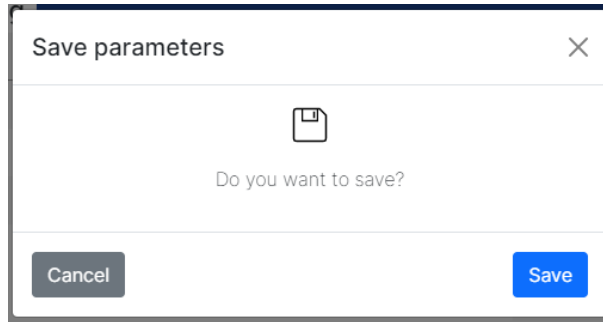

If [Save] was clicked, the following dialog appears:

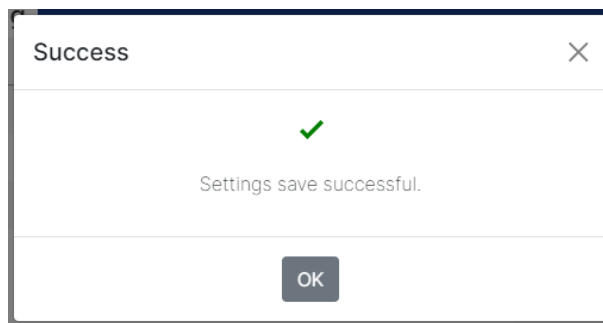

Click [Ok] to save finally.

6.2 Display menu

- **Service contact**
 - View a QR code
- **QR Documentation**
 - View the QR code
- **View settings**
 - Viewing the following menus

Weighing ·

- **Measuring time**
- **Digital filter**
- **Cut-off frequency**
- **Standstill time**
- **Standstill range**
- **Tare condition**
- **Tare timeout**
- **Zeroset range**
- **Zerotrack**
- **Zerotr. indic. range**
- **Zerotrack step**
- **Zerotrack time**
- **Overload**
- **LC voltage**
- **Mass unit**
- **Scale interval**

Adjustment ·

- **Dead load**
- **Adjusted at**
- **Max. capacity**
- **Sensitivity**

Interfaces

- Network
 - Hardware address
 - Use DHCP
 - Network address
 - Subnet mask
 - Gateway
 - Modbus TCP adr.
- Serial Interface
 - Protocol
 - Baud rate
 - Data bits
 - Parity
 - Stop bits
- Digital I & O
 - Input 1...3
 - Output 1...3
- Analog output
 - Mode
 - Range
 - Output on wgt. err.
 - On <0
 - On >Max
 - Weight value f. 0/4 mA
 - Weight value f. 20 mA
- ProfiBus-DP
 - Slave address
- DeviceNet
 - Slave address
 - Baud rate
 - DeviceNet MAC-ID
- CC-Link
 - Slave address

- Baud rate
- ProfiNet I/O
 - IP address
 - Subnet mask
- EtherNet/IP
 - Use DHCP
 - IP address
- EtherCAT
 - IP address
 - Subnet mask

System

- Languages
 - Operation language
 - Display language
- Date & Time
 - Date format
 - Date seperator
 - Time format
 - Time seperator
- Info
 - Battery status
 - Version
 - Board number

Application

- Limits
 - Limit 1...3 on
 - Limit 1...3 off

6.3 WEB menu

6.3.1 Weighing points

ADC parameters

- **Measure time**

Selection: 10 ms, 20 ms, 40 ms, 80 ms, 160 ms, 320 ms, 640 ms

- **Digital filter**

Selection: none, Bessel, Aperiodic, Butterworth, Tschebyscheff

- **Cut-off frequency**

Input: 0.00...40.00 Hz

- **Standstill time**

Input: 0.00...2 s

- **Standstill range**

Input: 0.01...10.00 d

- **Tare condition**

Selection: Tare without standstill, Tare after standstill

- **Tare timeout**

Input: 0.00...25.00 s

- **Zeroset range**

Input: 0.00...10000.00 d

- **Zerotrack**

Selection: Yes, No

- **Zerotrack indic. range**

Input: 0.25...10000.00 d

- **Zerotrack step**

Input: 0.00...40.00 d

- **Zerotrack time**

Input: 0.1...25.0 s

- **Overload**

Input: 0...9999999 d

Adjustment- **New**- **Max. capacity**

Input: Weight value with decimal place, mass unit

- **Scale interval**

Selection: corresponding value

- **Dead load**

Selection: By load, By mV/V

- **Adjusted at**

Selection: By load, By mV/V, By LC data

- **Modify**- **Dead load**

Selection: By load, By mV/V

- **Adjusted at**

Selection: By load, By mV/V, By LC data

- **By LC data**- **Number of loadcells**

Selection: 1...8

- **Max. capacity of loadcell**

Input: Max. capacity E_{\max} of one load cell

- **Gravity**

Input: Gravity at the place of installation; default is the value for Hamburg, Germany: 9.81379 m/s^2

- **Hysteresis error**

Selection: not specified, specified

- **Correction A**

Only by selection "specified"

Input: from the calibration certificate of the load cell under "Hysteresis Correction A"

- **Correction B**

Only by selection "specified"

Input: from the calibration certificate of the load cell under "Hysteresis Correction B"

- **Certified data**

Selection: All load cells same, Each load cell specific

- **LC output at max. capacity**

Only by selection "All load cells same"

Input: from the calibration certificate of the load cell under "Output at max. capacity"

- **LC output impedance**
Only by selection "All load cells same"
Input: from the calibration certificate of the load cell under "Output impedance"
- **LC 1...8 output at max. capacity**
Only by selection "Each load cell specific"
Eingabe: from the calibration certificate of the load cell under "Output at max. capacity"
- **LC 1...8 output impedance**
Only by selection "Each load cell specific"
Input: from the calibration certificate of the load cell under "Output impedance"

6.3.2 Application settings

Limits ·

- **Limit 1...3 on**
Input: Weight value
- **Limit 1...3 off**
Input: Weight value

6.3.3 Interfaces

Serial Interface ·

- **Protocol**
Selection: Kein, Fernanzeige, SMA, Modbus-RTU
- **Baud rate**
Selection: 300, 600, 1200, 4800, 9600, 19200 baud
- **Data bits**
View: protocol-dependent
- **Parity**
View: protocol-dependent
- **Stop bits**
View: protocol-dependent

Digital Inputs & Outputs ·

- **Input 1...3**
Selection: None, Set zero, Set tare, Reset tare
- **Output 1...3**
Selection: None, ADC error, Limit 1, Limit 2, Limit 3, Tare active

Network

- **Use DHCP**
Selection: On, Off
- **Network address**
Input: Valid IP address
- **Subnet mask**
Input: Valid IP address
- **Gateway**
Input: Valid IP address

Note: The currently installed card is displayed.

Other interfaces

- **Fieldbus**
 - **ProfiBus-DP**
 - **Slave address**
Input: 1...126
 - **DeviceNet**
 - **Slave address**
Input: 1...128
 - **Baud rate**
Selection: 125 k, 250 k, 500 k
 - **DeviceNet MAC-ID**
Input: 1...62
 - **CC-Link**
 - **Slave address**
Input: 1...64
 - **Baud rate**
Selection: 156 k; 625 k; 2,5 M; 5 M, 10 M
 - **ProfiNet I/O**
 - **Network address**
Input: Valid IP address
 - **Subnetzmaske**
Input: Valid IP address
 - **EtherNet/IP**
 - **Use DHCP**
Selection: On, Off
 - **Network address**
Input: Valid IP address

- **EtherCAT**
 - **IP address**
Input: Valid IP address
 - **Subnet mask**
Input: Valid IP address
- **Analog output**
 - **Mode**
Selection: None, Transparent, Gross, Net, Select (Gross/net value output on the display via D11)
 - **Range**
Selection: 0...20 mA, 4...20 mA
 - **Output on wgt. err.**
Selection: Hold, 0 mA, 4 mA, 20 mA
 - **On <0**
Selection: Linear, 0 mA, 4 mA, 20 mA
 - **On >Max**
Selection: Linear, 0 mA, 4 mA, 20 mA
 - **Analog value**
Only by selection mode "Transparent"
Input: fixed analog value
 - **Weight value for 0/4 mA**
Input: Weight value
 - **Weight value for 20 mA**
Input: Weight value
 - **Adjustment for 4 mA**
Input: Weight value
 - **Adjustment for 20 mA**
Input: Weight value

6.3.4 System

- **Operation language**
Selection: <English>, Japanese, German, French, Spanish, Italian
- **Display language**
Selection: <English>, German
- **Battery status**
View: Ok, Low
- **Current Date & Time**
- **Date format**
Selection: ddmmyyyy, mmddyyyy, yyyyMMdd, yyyyddmm
d = day, m = month, y = year
- **Date separator**
Selection: Slash '/', Hyphen '-', Period '.'
- **Time format**
Selection: 12 h, 24 h
- **Time separator**
Selection: Colon ':'

6.3.5 Service

- **Contact address**
Input of the address. When saving, a QR code is automatically generated and shown in the display.
- **QR Documentation**
View the QR code
- **Backup/Restore/Factory reset**
Selection: Backup, Restore, Factory reset
- **Configuration log**
View
- **Error log**
View

6.4 Assign password

When the device is booted, the following window appears:

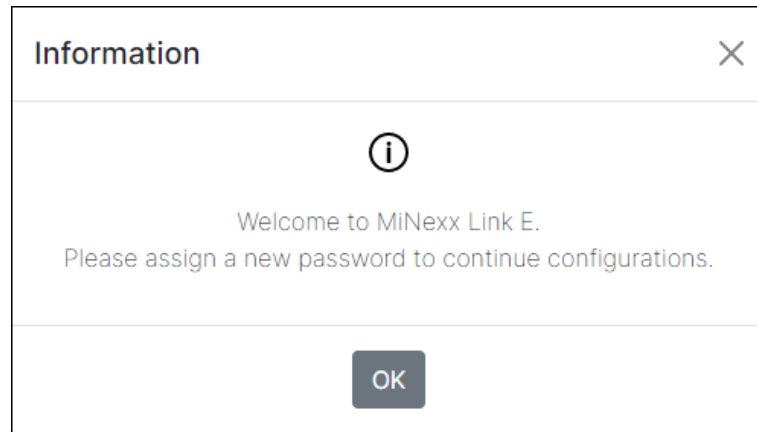

1. Click [OK].
 - ▷ The input field appears.

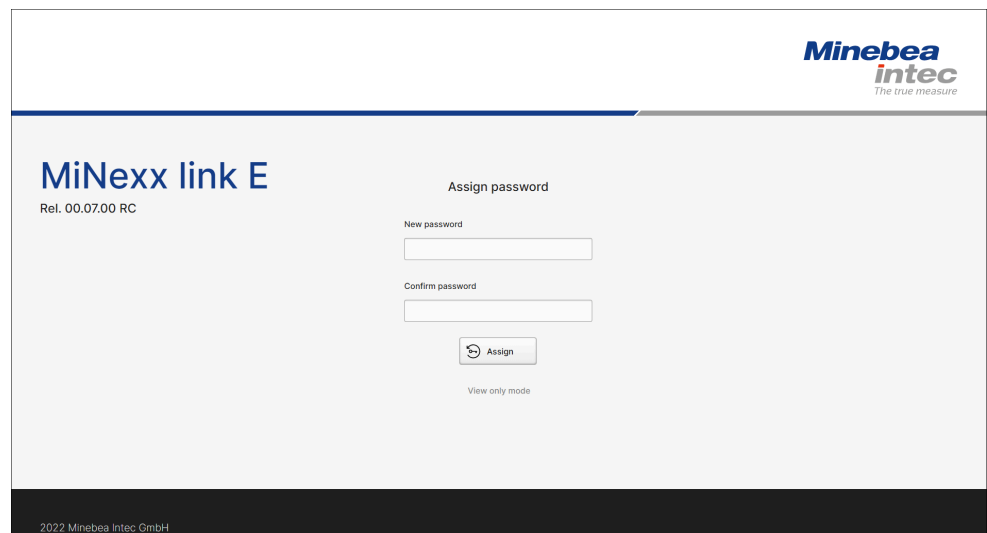

2. Click the [New password] input field and enter a password.
3. Click the [Confirm password] input field and enter the password again.
4. Click [Assign] to save the entry.
 - ▷ The login window appears.

Minebea
intec
The true measure

MiNexx link E

Rel. 00.07.00 RC

Password

[Forgot Password](#) [View only mode](#)

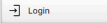
 Login

2022 Minebea Intec GmbH

5. Enter the previously assigned password under [Password].
6. Click [Login].
 - ▷ The window [ADC parameters] appears.

6.5 Change password

1. Click [Change password] in the header under



- ▷ An input window appears.

A screenshot of a web application interface. At the top, there is a blue header bar with a menu icon, a scale reading "Max 10000 g 4-0.1g" and "0.0 g", a user profile icon labeled "Admin", the language "English", and the date "19-07-2022 14:35:09". Below the header, the page title is "Change Password". The main content area contains three input fields labeled "current password", "New password", and "Confirm password". At the bottom of the form is a "Submit" button with a circular arrow icon.

2. Enter the current password.
3. Enter the new password.
4. Enter the new password again and click [Submit].

6.6 Error logging in

If an incorrect password is entered when logging in, the following window will appear.

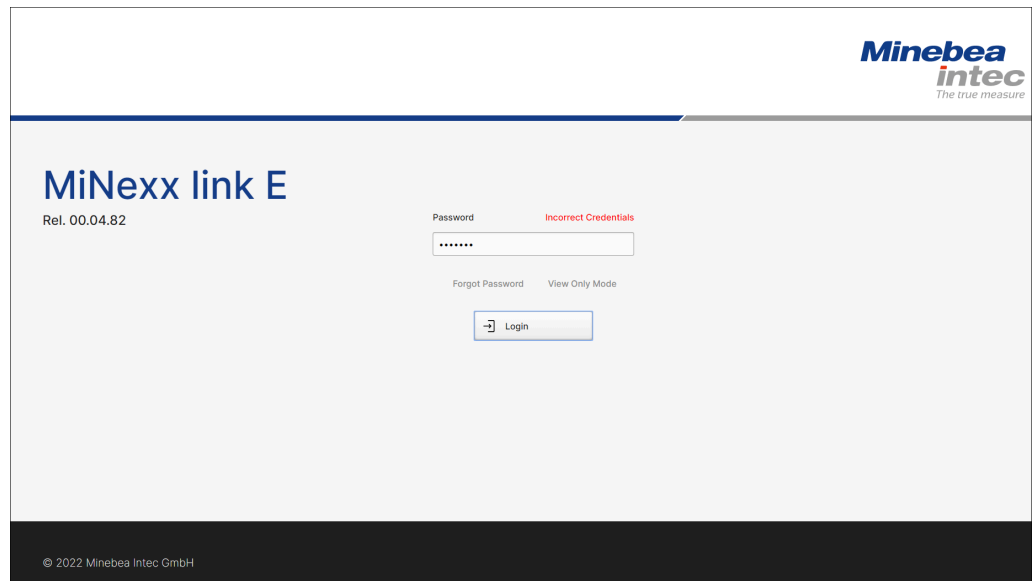

If the password has been lost, it must be unlocked.

The following steps are necessary to unlock the password.

1. Click [Forgot Password].
 - ▷ An information window appears.
2. Paste this information into an e-mail message and send to "help@minebea-intec.com".
3. Take the unlock answer from the e-mail and enter it under [unlock answer].
4. Enter the new password.
5. Enter the new password again and click [Reset].

6.7 Select language

How to select the language?

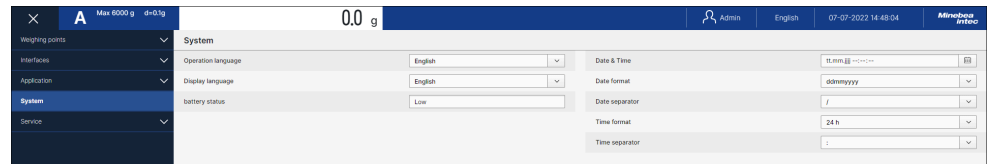



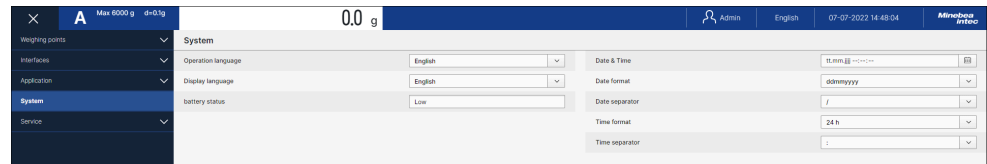

1. Click ▼ in the [Operating language] line.
 - ▷ A selection window appears.
 - Selection: English (default), Japanese, German, French, Spanish, Italian
2. Select the desired operating language.
3. Click ▼ in the [Display language] line.
 - ▷ A selection window appears.
 - Selection: English (default), German
4. Select the desired display language.
5. Save the settings.

6.8 Current date & time

How are the date and time set?



1. Click  in the row [Current date & time].
 - ▷ A calendar appears.
 - Selection/input: day, month, year, current time
2. Click  in the row [Date format].
 - ▷ A selection window opens.
 - Selection: ddmmyyyy, mmdyyy, yyyyymmdd, yyyyddmm
3. Click  in the row [Date separator].
 - ▷ A selection window opens.
 - Selection: Forward slash '/', dash '-', period '.'
4. Click  in the row [Time format].
 - ▷ A selection window opens.
 - Selection: 12 h, 24 h
5. Click  in the row [Time separator].
 - ▷ A selection window opens.
 - Selection: Colon ':'
6. Save the settings.

6.9 Serial interface



: [Interfaces]

1. Click [Serial interface].
 - ▷ A selection window appears.
2. Select the individual parameters and change them if necessary.
 - [Protocol]
 - Selection: None, Remote display, SMA, Modbus-RTU
 - [Baudrate]
 - Selection: 300, 600, 1200, 4800, 9600, 19200 Baud
 - Other parameters are protocol specific.
3. Save the settings.

6.10 Digital inputs & outputs



: [Digital inputs & outputs]

1. Select the individual parameters and change them if necessary.
 - [Input 1...3]
 - Selection: None, Set zero, Set tare, Reset tare
 - [Output 1...3]
 - Selection: None, ADC error, Limit 1, Limit 2, Limit 3, Tare active
2. Save the settings.

6.11 Defining limits

Each limit consists of a switch-on and a switch-off point for definition of a hysteresis. The 3 pairs of values must be entered according to the same principle. The limit values always refer to the gross weight. SPM addresses for the limits, see Chapter [System data](#).

Example 1:

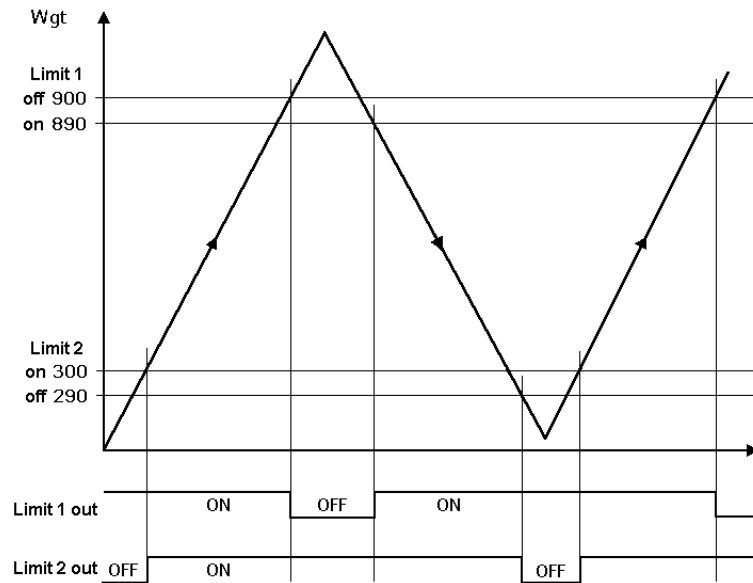

The output signal (Limit 1 out) of limit 1 (Limit 1) switches OFF above a weight (Wgt) of 900 kg.

The output signal (Limit 2 out) of limit 2 (Limit 2) switches OFF below a weight of 290 kg.

The two limit values have a hysteresis of 10 kg.

In the event of a power failure, the two outputs go to OFF, thus indicating under filling and over filling at the same time.

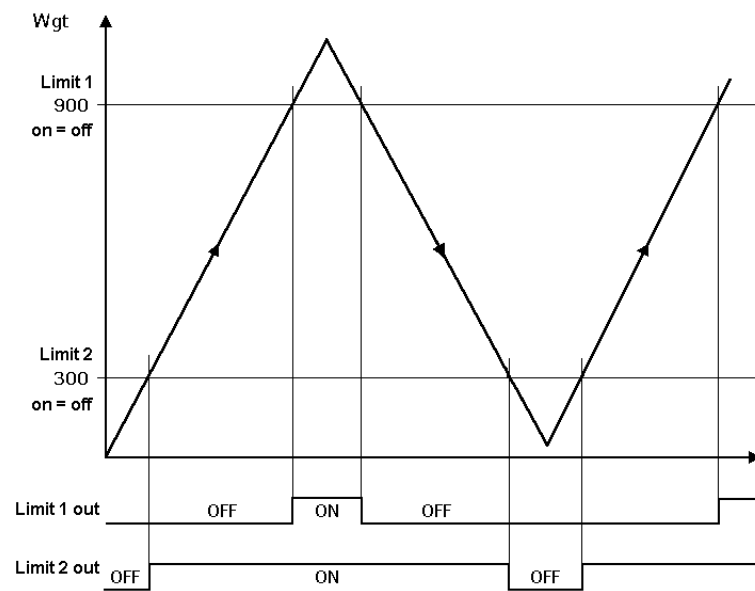
Example 2:

If limits 1 and 2 are the same for 'On' and 'Off' (on = off),

- output 1 (Limit 1 out) switches ON if the weight (Wgt) exceeds the value.
- output 2 (Limit 2 out) switches OFF if the weight falls below the value.



: [Limits]

1. Select the individual parameters and change if necessary.

[Limit 1...3 on]

Input: Weight value

[Limit 1...3 off]

Input: Weight value

2. Save the settings.
3. Save the changes.

6.12 Configuring the analog output

The weight value of the weighing point is transmitted to the output.



: [Analog output] or [CombiCard]

The analog output can be configured according to the table below.

Parameter table

Parameter	Selection	Description
[Mode]	[Off]	Analog output is unused.
	[Transparent]	Value output in D30. Instrument is controlled via PLC.
	[Gross]	Gross weight output in D8.
	[Net]	Net weight output in D9; only if tared, otherwise gross weight is output.
	[Select]	Gross/net value output on the display (D11) depending on SPM bit X72.
[Range]	[0...20 mA]	Outputs 0...20 mA.
	[4...20 mA]	Outputs 4...20 mA.
[Output on wgt. err.]	[Hold]	If an error occurs, the analog output retains the last value.
	[0 mA]	If an error occurs, the analog output is set to 0 mA.
	[4 mA]	If an error occurs, the analog output is set to 4 mA.
	[20 mA]	If an error occurs, the analog output is set to 20 mA.

Parameter table (continued)

Parameter	Selection	Description
[On <0]	[linear]	In the event of a negative weight, the analog output is retained. This is only possible if the output value for the zero weight is >0 mA.
	[0 mA]	In the event of a negative weight, the analog output is set to 0 mA.
	[4 mA]	In the event of a negative weight, the analog output is set to 4 mA.
	[20 mA]	In the event of a negative weight, the analog output is set to 20 mA.
[On > Max]	[linear]	In the event of a weight >Max, the analog output is retained. This is only possible if the output value for Max is <20 mA.
	[0 mA]	In the event of a weight >Max, the output is set to 0 mA.
	[4 mA]	In the event of a weight >Max, the output is set to 4 mA.
	[20 mA]	In the event of a weight >Max, the output is set to 20 mA.
[Analog value]	Input: fixed analog value	Only possible if [Transparent] mode is selected.
[Weight value at 0/4 mA]	Input: Weight value	Weight value at which the analog output should display 0 mA. or Weight value at which the analog output should display 4 mA (for the analog range 4... 20 mA).
[Weight value at 20 mA]	Input: Weight value	Weight value at which the analog output should display 20 mA.
[Adjust for 4 mA]	Input: Weight value	Value at 4 mA.
[Adjust for 20 mA]	Input: Weight value	Value at 20 mA.

6.13 Metrology parameters



: [ADC parameters]

ADC parameters	
Measuring time	100 ms
Digital filter	Noise
Cut-off frequency	2.00 Hz
Standstill time	0.50 s
Standstill range	1.00 d
Tare condition	Tare after standstill
Tare timeout	0.25 s
Zerocut range	50.00 d
Zerotrack	Yes
Zerotrack indicator range	0.25 d
Zerotrack step	0.25 d
Zerotrack time	1.0 s
Overload	9 d

1. Select the individual parameters and change them if necessary.

[Measuring time]

Measuring time: The duration of a measurement can be selected.

Selection: 10 ms, 20 ms, 40 ms, 80 ms, 160 ms, 320 ms, 640 ms

[Digital filter]

Note: After changing the filter parameters, a new adjustment may be necessary to ensure maximum accuracy.

The following includes examples of interference signals for the different filter types:

Bessel filter

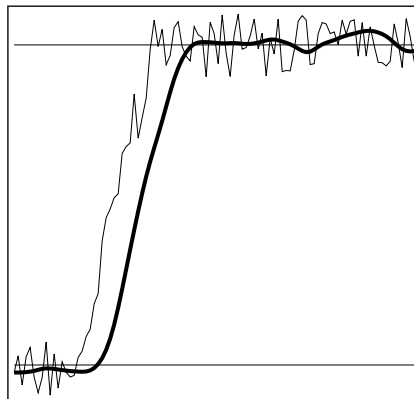

Aperiodic filter

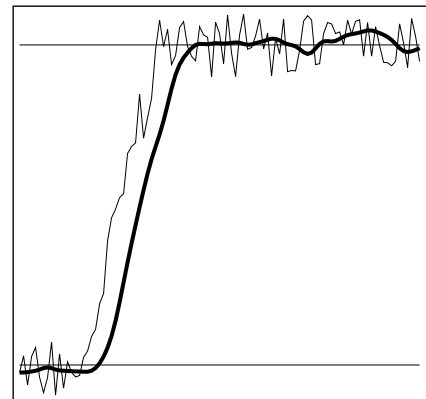

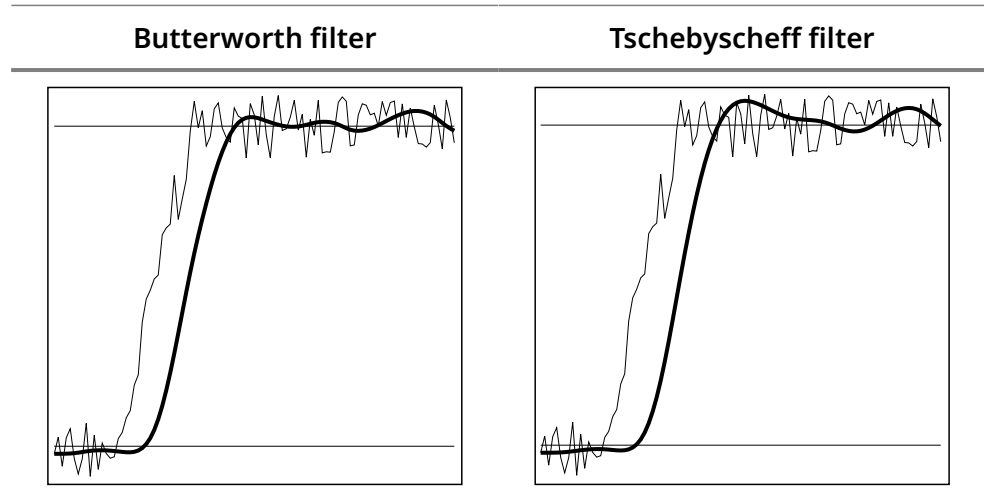

A digital filter can be switched on only with the measuring time set to ≤ 160 ms.

Selection of the digital filter (filter characteristic): none, Bessel, aperiodic, Butterworth, Tschebyscheff

If no particularly frequent fluctuations are expected in ongoing operation, the following settings are recommended:

- [Measuring time]: ≤ 160 ms
- [Digital filter]: Aperiodisch
- [Cut-off frequency]: 2.00 Hz

[Cut-off frequency]

The smaller the cutoff frequency, the slower the measurement and the more stable the measurement result.

Input: 0.01 to 40.00 Hz

The available options depend on the measurement time.

The parameter [Cut-off frequency] is only selectable if the digital filter is switched on.

[Standstill time]

The parameters [Standstill time] and [Standstill range] define the stability of the scale (stable balance position).

Input: 0.00 to 2.00 s; the standstill time must not be less than the measuring time.

[Standstill range]

As long as the weight fluctuations remain within this range, the device is determined to be stable.

Input: 0.01 to 10.00 d

[Tare condition]

Selection: Tare without standstill, Tare after standstill

[Tare timeout]

Timeout for a tare/zeroreset command that cannot be executed (e.g. due to mechanical instability of the scale, incorrect filter setting, resolution too high, standstill condition too strict).

Input: 0.00 to 25.00 s.

At 0.0 s taring is only carried out when the scale is already stable.

[Zeroreset range]

Define a \pm range around the zero point determined by the dead load during adjustment; within this range

- the displayed gross weight can be set to zero by a corresponding external command, and
- automatic zero tracking is active.

Input: 0.00 to 10000.00 d

[Zeroreset]

The zero display is automatically maintained within set limits.

Selection: No, Yes

When [No] is selected, the next three parameters are not shown.

When [Yes] is selected, values for the next three parameters must be entered.

[Zeroreset indic. range]

Indication range within which automatic zeroreset compensates for deviations.

Input: 0.25 to 10000.00 d

[Zeroreset step]

If a weight change exceeds the adjusted value, automatic tracking does not function any more.

Input: 0.25 to 10000.00 d

[Zerotrack time]

Time interval for automatic zerotrack.

Input: 0.1 to 25.0 s

[Overload]

Weighing range above the maximum capacity (Max) without error message.

Input: 0 to 999999 d; 9 d (default)

2. Save the settings.

6.14 Calibrating internal weighing point

6.14.1 General instructions

The transmitters of the PR 5215 series do not have legal-for-trade approval. The legal-for-trade application of PR 5215 with other devices has to be verified.

The adjustment data are protected by the CAL switch (see Chapter [CAL switch](#)).

Note: The [Modify] menu item is only used for small changes (e.g. changing the dead load/preload, changing the mV/V values for dead load/preload and/or Max, changing the scale interval). Otherwise select the [New] menu item.

6.14.2 Performing a new adjustment

Requirements:

- Overwrite protection is deactivated, see Chapter [CAL switch](#).



: [Adjustment]

1. Click [New] in the task bar.
 - ▷ The data is first set to factory setting (default) and then the adjustment is started.
2. Setting max. capacity [Max. capacity], see Chapter [Determining max. capacity \(Max\)](#).
3. Determining the scale interval [Scale interval], see Chapter [Determining the scale interval](#).
4. Determining the dead load [Dead load], see Chapter [Determining the dead load](#).
5. Adjustment with weight [Adjusted at], see Chapter [Adjustment with weight](#).

or
6. Adjustment with mV/V value [Adjusted at], see Chapter [Adjusting with calculated mV/V value](#).

or
7. Adjustment with load cell data (SMART calibration) [Adjusted at], see Chapter [Adjusting with load cell data \(SMART calibration\)](#).
8. Activate the overwrite protection after finishing the adjustment, see Chapter [CAL switch](#).

6.14.2.1 Determining max. capacity (Max)

The max. capacity (Max) determines the max. weight without dead load of the weight to be measured and the displayed number of digits behind the decimal point. Normally, Max is less than the load cell capacity (max. capacity of load cell × number of load cells).

Permissible values for the max. capacity are:

Max weight value from 0.00010 to 999999 in t, kg, g, or lb.

Maximum weight value must be an integer multiple of the scale interval (d). It may have up to 6 digits and is entered as a numeric value with or without a decimal point.

1. Under [Max. capacity] enter max. capacity with decimal places (in this example: 6000) and select the mass unit (in this example: g).
2. Click [Set max. capacity] in the task bar to save the entries.

6.14.2.2 Determining the scale interval

The scale interval (d) is the difference between two successive display values.

Example:

Max. capacity (Max) = 6000 g

Scale interval (d) = 2 g

Calculation for scale interval for max. capacity (Max) (automatic):

$d = \text{Max} / \text{Scale interval}$

$d = 6000 \text{ g} / 2 \text{ g}$

$d = 3000$

The mass unit is taken from [Max. capacity]. The number of digits behind the decimal point is also automatically determined when [Max. capacity] is entered.

1. Under [Scale interval] select "2".
2. Click [Set scale interval] in the task bar to save the entries.
 - ▷ The max. capacity (Max) and the scale interval are displayed in the header in the weighing point/metrology area.

6.14.2.3 Determining the dead load

To use the empty scale/hopper as dead load (normal case):

1. Clear the scale/hopper.
2. Click [by load] in the task bar.
3. Click [Set dead load] in the task bar to save the dead load.

Note:

If the mV/V value of the dead load was calculated, or if it is known from the previous adjustment, the value can be overwritten by pressing [by mV/V].

Calculate dead load

Voltage equivalent [mV/V] = dead load × load cell sensitivity C_n [mV/V] / load cell capacity (maximum capacity E_{\max} × number of load cells)

load cell sensitivity C_n = rated output C_n (see technical data for the load cell)

Normally, calculation of the dead load (scale without load or empty vessel) is not necessary.

Subsequent dead load correction can be used for later re-determination of the dead load, when the scale or vessel is empty.

Example:

- 1 load cell with rated output $C_n = 2$ mV/V
- At max. capacity 2000 kg (LC)
- Max. capacity (Max) 1000 kg
- Dead load 500 kg
- Load cell supply voltage $U_{DC} = 5$ V

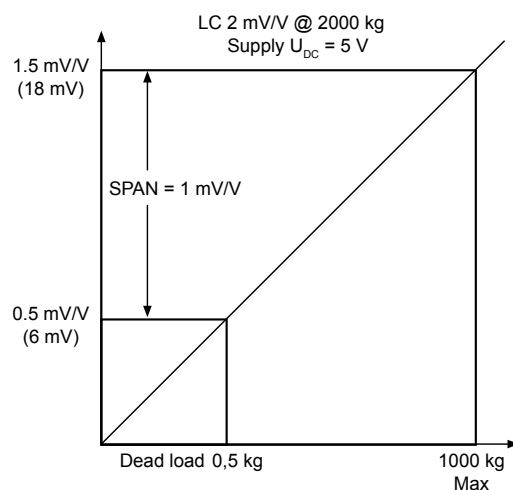

6.14.2.4 Adjustment with weight

1. Click [by load] in the task bar.
2. Enter the weight value of the calibration weight in the line [Adjusted at].
3. Place the calibration weight on the scale.
4. Click [Adjust] in the task bar.
 - ▷ Weight value, weight unit and measuring signal in mV/V corresponding to this value are displayed in the line [Adjusted at]
5. Save the adjustment.

6.14.2.5 Adjusting with calculated mV/V value

The scale can be adjusted without weights. During input of the load cell mV/V value, the acceleration of gravity at the place of installation can be taken into account.

The PR- load cell data is based on the acceleration of gravity in Hamburg, Germany:

9.81379 m/s².

Calculating Span

Span indicates the equivalent input voltage in mV/V related to the maximum capacity (Max) of the scale. It is calculated as follows:

Span [mV/V] = max. capacity (Max) × load cell sensitivity C_n [mV/V] / load cell capacity (max. capacity E_{max} × number of load cells)

load cell sensitivity C_n = rated output C_n (see technical data for the load cell).

Adjusting with mV/V

1. Click [by mV/V] in the task bar.
2. Enter the calculated Span value in the line [Adjusted at].
3. Click [Adjust] in the task bar.
 - ▷ Weight value, weight unit and measuring signal in mV/V corresponding to this value are displayed in the line [Adjusted at].
4. Save the adjustment.

6.14.2.6 Adjusting with load cell data (SMART calibration)

If the scale is not used in legal metrology, adjustment without weights can be performed.

The easiest method is the one using load cell data without calculation. The values are taken from the technical data and the calibration certificate of the load cell.

1. Click  in the task bar.
2. Enter the following values.

[Number of loadcells]

Number of load cells connected in parallel

Selection: 1 to 8

[Max. capacity of loadcell]

Maximum capacity E_{\max} of a load cell (not the total maximum capacity of the scale!)

Input: For the value refer to the technical data of the load cell.

[Gravity]

Gravity at place of installation. Default is the value for Hamburg, Germany: 9.81379 m/s^2 .

[Hysteresis error]

Selection: not specified, specified

When switching from [not specified] to [specified] values for [Correction A] and [Correction B] must be entered.

[Correction A]

Only with selection [specified]

Input: refer to the load cell certificate under "Hysteresis Correction A"

[Correction B]

Only with selection [specified]

Input: refer to the load cell certificate under "Hysteresis Correction B"

[Certified data]

Selection: All load cells the same, Each load cell individual

[LC Output at max. capacity]

Only with selection [All load cells the same]

Input: refer to the load cell certificate under "Output at max. capacity"

[LC output impedance]

Only with selection [All load cells the same]

Input: refer to the load cell certificate under "Output impedance"

[LC 1 to 8 Output at max. capacity]

Only with selection [Each load cell individual]

Input: refer to the load cell certificate under "Output at max. capacity"

[LC 1 to 8 output impedance]

Only with selection [Each load cell individual]

Input: refer to the load cell certificate under "Output impedance"

Note:

LC = Load cell

3. Save the adjustment.

6.14.3 Modifying a adjustment

[Modify] may be used only for minor changes (e.g. changing the dead load, adapting mV/V values for dead load and/or Max). Otherwise, always use [New]!

Requirements:

- Overwrite protection is deactivated, see Chapter [CAL switch](#).



: [Adjustment]

1. Click [Modify] in the task bar.
2. Setting max. capacity [Max. capacity], see Chapter [Determining max. capacity \(Max\)](#).
3. Determining the dead load [Deadload], see Chapter [Determining the dead load](#).
4. Activate the overwrite protection after finishing the adjustment, see Chapter [CAL switch](#).

6.14.3.1 Subsequent dead load correction

If the vessel/platform weight changes by an amount that is higher than the zero range; e.g. due to dead load reduction, dead load increase, or mechanical changes, the functions for automatic zero-track and manual zero setting no longer work.

If the full zero-setting range is already being utilized, you can still correct the dead load without affecting other adjustment data/parameters.

Requirements:

- Overwrite protection is deactivated, see Chapter [CAL switch](#).
- The scale is unloaded.

1. Click [Modify adjustment] in the task bar.
2. Click [Modify dead load] in the task bar.
3. Click [by load] in the task bar.
4. Clear the scale/hopper.
5. Click [Set dead load] in the task bar to save the entries.
6. Save adjustment.

7 ModBus protocol

7.1 General description

The ModBus protocol implemented in the device enables rapid, simple, and reliable communication between a PC or PLC and up to a maximum of 127 devices.

The ModBus protocol allows access to all data published in the SPM table of the relevant application.

Implementation:

The functions 1, 2, 3, 4, 5, 6, 8, 15, and 16 are supported.

Bits can only be read or set individually or in groups of eight.

8 SMA protocol

8.1 General description

The protocol of the "Scale Manufacturers Association" (SMA) provides a simple access to the scale. It can be used for reading data, or for executing functions.

The RS-485 interface is used as an interface.

Fixed interface settings are 8 bits, no parity and 1 stop bit.

The commands to the transmitter are printable ASCII characters starting with <LF> = 0A hex and ending with <CR> = 0D hex.

The transmitter sends a reply on each received command after approx. 100 ms. With commands that wait for standstill of the weight value, the reply can be delayed by the timeout.

The following commands are supported:

W, Z, D, A, B, <ESC>, H, P, Q, R, S, T, M, C, I, N

9 Fieldbus interface

9.1 General notes

The PR 5215 can be included under a communication master (e.g. Siemens S7 ProfiBus) as a field bus slave.

The update rate is 50 ms.

The field bus exchanges its data cyclically with each slave. That means: In each cycle, the entire data range is written and read, even if there are no changes to the data content.

Concept definition

Term/Abbreviation	Description
Master	Field bus master, usually an SPS
Slave	Field bus device
MOSI	Master Out Slave In = data is written from the SPS via the field bus to the device.
MISO	Master In Slave Out = data is returned from the device via the field bus to the SPS.

9.2 Scale protocol

The interface works with an 8-byte write window and an 8-byte read window for a weighing point.

Note:

All fieldbus data is only valid, if 'Read_Value_Selected' has been reflected.

9.2.1 Data exchange range

Overview

Byte	0, 1, 2, 3	4	5	6, 7
MOSI	Write data	Read_Value_Select	Write_Value_Select	Control bits
MISO	Read data	Read_Value_Selected	Status bits	Status bits

Write window (MOSI)

Byte	Field									Description
0	Write data (MSB)									Contains the data to be written, e.g., analog output.
1	Write data									
2	Write data									
3	Write data (LSB)									
4	Read_Value_Select									Selects the function for reading data.
5	Write_Value_Select									Selects the function for writing data.
6	free	free	free	free	free	free	free	free	free	In direct access, control bits are independent of the write or read request.
7	Get Fix Tare	Set Fix Tare	Res Power	Res Test	Set Test	Res Tare	Set Tare	Set Zero		
	Bit 7	Bit 6	Bit 5	Bit 4	Bit 3	Bit 2	Bit 1	Bit 0		

Field	Size	Function
Write data	4 bytes	Data to be written as a binary 32-bit value with plus or minus sign. Data type: DINT
Read_Value_Select	1 byte	Function for selecting the read request
Write_Value_Select	1 byte	Function for selecting the write request
ResPower	1 bit	PowerFail is reset.
ResTest	1 bit	The test operating mode is finished.
SetTest	1 bit	The test operating mode is started.

Field	Size	Function
		Now the test value can be read out by reading the gross weight.
ResTare	1 bit	Tare is reset.
SetTare	1 bit	The weighing point is tared.
SetZero	1 bit	The weighing point is set to zero.

Read window (MISO)

Byte	Field									Description
0	Read data (MSB)									Contains the data to be written, e.g. gross value.
1	Read data									
2	Read data									
3	Read data (LSB)									
4	Read_Value_Selected									Read_Value_Select (function) from the write window is mirrored if the data in "Read data" is available.
5	Write Active	Power Fail	Output 3	Output 2	Output 1	Limit 3	Limit 2	Limit 1	In direct access, status bits are independent of the write or read request.	
6	Cmd Busy	Cmd Error	Input 3	Input 2	Input 1	Tare Active	Cal Changed	Test Active		
7	OutOf Range	Standstill	Inside ZSR	Center Zero	Below Zero	Overload	Above Max	ADC Error		
	Bit 7	Bit 6	Bit 5	Bit 4	Bit 3	Bit 2	Bit 1	Bit 0		

Field	Size	Function
Read data	4 bytes	Data to be read as a binary 32-bit value with plus or minus sign. Data type: DINT
Read_Value_Selected	1 byte	Acknowledgment of the transmitted function number.
WriteActive	1 bit	The function selected with Write_Value_Select has been executed once. This bit is deleted if Write_Value_Select is set to 0.
PowerFail	1 bit	Is set when switching on the device. Is reset by ResPower with transition from 0 → 1.
CmdBusy	1 bit	The device is busy executing a function (e.g., waiting for a standstill for taring)
CmdError	1 bit	The device has interrupted the execution of a command (e.g., standstill could not be reached within the defined standstill time). The error number can be read from "LASTERROR", see Chapter Function number 4: adjustment information, error byte (read) .
Tare_Active	1 bit	The scale has been tared.
Cal_Changed	1 bit	The device has been calibrated. When this bit is 1, the weighing point parameters (EXPO/UNIT/STEP+FSD) must be read again. Set after "Power on" and reset after reading the FSD.
Test_Active	1 bit	The device executes the ADC test. The read weight value is not the gross value, but the test value.
OutOfRange	1 bit	Below zero or above Max (FSD).
Standstill	1 bit	The scale is stable.
InsideZSR	1 bit	The gross weight value is within the zero setting range.

Field	Size	Function
CenterZero	1 bit	The weight value is within center zero ($0 \pm 0.25 d$).
BelowZero	1 bit	The weight value is negative (gross < 0 d).
Overload	1 bit	The weight value has exceeded the measuring range. No valid weight data is specified (gross > FSD+overload).
AboveMax	1 bit	The weight value has exceeded Max (FSD), but is still within Max + permissible overload (gross \leq FSD+overload).
ADCErrror	1 bit	AD conversion error, see Chapter Function number 1: scale status (read) .

9.2.2 Reading and writing data with function numbers

9.2.2.1 Reading data

Procedure:

1. Write the function number as **Read_Value_Select** in byte 4 of the write window (e.g., 9 = net weight).
2. Wait until **Read_Value_Selected** in byte 4 of the read window is equal to **Read_Value_Select** of the write window.
 - ▷ The requested value is available in bytes 0-3.

Action of the master	Slave reaction
Write function number to Read_Value_Select .	
	Write requested data in Read_Data (bytes 0-3).
	Copy Read_Value_Select to Read_Value_Selected .
Wait until Read_Value_Selected = Read_Value_Select .	
Read requested data in Read_Data (bytes 0-3).	

9.2.2.2 Writing data

Procedure:

1. Wait until **Write_Active** = 0 in the read window (slave is ready to receive new data).
2. Write value in bytes 0-3 of the write window.
3. Write the function number as **Write_Value_Select** in byte 5 of the write window.
4. Wait until **Write_Active** = 1 in the read window.
5. Write 0 in byte 5 (**Write_Value_Select**).
 - ▷ **Write_Active** is reset.

Action of the master	Slave reaction
Write value in Write_Data (bytes 0-3).	
Write function number to Write_Value_Select .	
	Read data from Write_Data (bytes 0-3).
	Set the Write_Active bit.
Wait until Write_Active has been set.	
Write 0 in Write_Value_Select .	
	Reset the Write_Active bit.

9.2.2.3 Writing bits

In addition to the control bits in bytes 6/7, further bits can be set and, if necessary, reset directly with **Write_Value_Select**.

To set bits 80 to 127, the corresponding function number is written to **Write_Value_Select** (see Chapter [Function numbers](#)).

To reset bits 80 to 89, the corresponding function number +128 (208 to 217) is written to **Write_Value_Select**.

Action of the master	Slave reaction
Writing the bit address as a function number to Write_Value_Select .	The bit from Write_Value_Select is set and the corresponding function carried out.
	Set the Write_Active bit.
Wait until Write_Active has been set.	
Write 0 in Write_Value_Select .	Reset the Write_Active bit.

9.2.2.4 Reading bits

Reading individual bits which are not contained directly in the read window is only possible with a corresponding function number and the data in **Read_Data** (Byte 0-3) of the read window. In those bytes, the bits must be evaluated individually.

The procedure is the same as that described in Chapter [Reading data](#).

9.2.3 Reading and writing bits directly

For reading status bits and for writing direct control bits, no procedure is required. The general status bits are always provided and need not be requested. The direct control bits are also available continuously.

9.2.3.1 Reading status bit

The status bits in bytes 5-7 of the read window are always available and can be read directly by the master.

9.2.3.2 Writing control bits

Some device functions can be executed by setting bits directly in bytes 6 and 7 (control bytes) of the write window.

Action of the master	Slave reaction
Set bits in the control byte .	Function is executed.
Reset bits in the control byte .	

9.2.4 Waiting for the result of the action

When an action requiring more time is started, the end of execution can also be waited for.

Action of the master	Slave reaction
For setting bits, see Chapter Writing bits or Writing control bits .	Set the CmdBusy bit.
	Function is executed.
	In the event of an error: Set the CmdError bit and the LastError byte.
	If the function is executed or timeout: reset the CmdBusy bit.
Wait until CmdBusy = 0.	
Check the CmdError bit.	
If CmdError is set: Evaluate the LastError (for function number 4, see Chapter Function number 4: adjustment information, error byte (read))	

Action of the master	Slave reaction
Set the ResetError bit (for function number 121, see Chapter Function number 112–121: transition-controlled action bits (write)).	The ResetError bit is reset.
	The CmdError bit is reset.

9.2.5 Function numbers

Function numbers are written to MOSI by the master (SPS) and reflected in MISO by the PR 5215.

- Function number 0: I/O status bits (read), see Chapter [Function number 0: I/O status bits \(read\)](#)
- Function number 1: scale status (read), see Chapter [Function number 1: scale status \(read\)](#)
- Function number 4: adjustment information, error byte (read), see Chapter [Function number 4: adjustment information, error byte \(read\)](#)
- Function number 5: device type and software version (read), see Chapter [Function number 5: device type and software version \(read\)](#)
- Function number 6: serial number of the weighing point (read), see Chapter [Function number 6: serial number of the weighing point \(read\)](#)
- Function numbers 8 to 15: weight data (read), see Chapter [Function number 8–11, 14: weight data \(read\)](#)
- Function numbers 22 to 27: Limit value (read/write), see Chapter [Function number 24–29: Limit value \(Read/Write\)](#)
- Function numbers 30, 31: values of the current weighing point (read), see Chapter [Function number 30, 31: Fixed values \(Read/Write\)](#)
- Function numbers 80 to 93: state-controlled action bits (write), see Chapter [Function number 80–89: state-controlled action bits \(write\)](#)
- Function numbers 112 to 119, 121 to 125: transition-controlled action bits (write), see Chapter [Function number 112–121: transition-controlled action bits \(write\)](#)

9.2.5.1 Function number 0: I/O status bits (read)

Dynamic status

	Bit 7	Bit 6	Bit 5	Bit 4	Bit 3	Bit 2	Bit 1	Bit 0
Byte 0						Input 3	Input 2	Input 1
Byte 1						Output 3	Output 2	Output 1
Byte 2						Limit 3	Limit 2	Limit 1
Byte 3								

9.2.5.2 Function number 1: scale status (read)

Dynamic status

	Bit 7	Bit 6	Bit 5	Bit 4	Bit 3	Bit 2	Bit 1	Bit 0
Byte 0	OutOf Range	Standstill	Inside ZSR	Center Zero	Below Zero	Overload	Above Max	ADU Error
Byte 1					E6	E1	E3	E7
Byte 2						Power-Fail	Action Active	CmdError
Byte 3						Tare Active	Cal Changed	Test Active

Note: Byte 0 corresponds to byte 7 in the output area. Weight error see table below.

Field	Function
ADUError	AD conversion error (OR function of bits E1, E3, E7).
AboveMax	The weight value has exceeded the Max (FSD), but is still within Max + permissible overload (gross \leq Max + overload).
Overload	The weight value has exceeded the measuring range. No valid weight data is specified (gross $>$ Max + overload); ERR 2 .
BelowZero	The weight value is negative (gross $<$ 0d).
CenterZero	The weight value is within center zero (0 ± 0.25 d)
InsideZSR	The gross weight value is within the zero setting range.
Standstill	The scale is stable.
OutOfRange	Below zero or above Max (FSD).
E9	The measuring signal is higher than the permissible range of 36 mV. Cannot read weight values from ADC (analog-digital converter) (ERR 9).
E7	The measuring signal is negative (inverse conversion) (ERR 7)
E6	Sense voltage not present or too low (ERR 6)
E3	The measuring signal is $>$ 36 mV (no end of conversion) (ERR 3)
CmdError	<p>Error during execution (CmdError); e.g., the "taring" operation is not processed, because the scale is not at a standstill. The error is stored in LastError (function number 4).</p> <p>The bit is reset with the ResetError bit (function number 121, see Chapter Function number 112–121: transition-controlled action bits (write)).</p>
ActionActive	The device is busy executing a function (e.g., waiting for downtime for taring).
PowerFail	Power failure; is always set after power on. The PowerFail bit is reset with the ResetPWF bit (function number 85, see Chapter Function number 80–89: state-controlled action bits (write)) "Reset power failure".

Field	Function
Test_Active	The device executes the ADC test. The read weight value is not the gross value, but the test value.
Cal_Changed	The device has been calibrated. When this bit is 1, the weighing parameters (EXPO/UNIT/STEP) must be read again. Set after "Power on" and reset after reading Max (FSD = Full scale deflection).
Tare_Active	The scale has been tared.

9.2.5.3 Function number 2: For internal use only.

9.2.5.4 Function number 3: For internal use only.

9.2.5.5 Function number 4: adjustment information, error byte (read)

Byte	Description
0: EXPO	One byte for the position of the decimal point; content in decimal form: 0 to 255.
	0 = 000000
	1 = 00000.0
	2 = 0000.00
	3 = 000.000

Byte	Description
1: UNIT	One byte for the weight unit; content in decimal form: 0 to 255
	1 = g (grams)
	2 = kg (kilograms)
	3 = t (tons)
	4 = lb (pounds)
2: STEP	One byte for the scale interval; content in decimal form: 0 to 255
	1 = scale interval "1"
	2 = scale interval "2"
	5 = scale interval "5"
	10 = scale interval "10"
	20 = scale interval "20"
	50 = scale interval "50"
3: LASTERROR	See Chapter Error numbers @ "LAST_ERROR"

Note:

Other error nos are possible.

9.2.5.6 Function number 5: device type and software version (read)

	Bit 7	Bit 6	Bit 5	Bit 4	Bit 3	Bit 2	Bit 1	Bit 0
Byte 0	TYPE MSB							
Byte 1	TYPE LSB							
Byte 2	MAINVERSION							
Byte 3	SUBVERSION							

e.g.: PR 5215 Rel 1.23 = 52150123_{hex}

9.2.5.7 Function number 6: serial number of the weighing point (read)

	Bit 7	Bit 6	Bit 5	Bit 4	Bit 3	Bit 2	Bit 1	Bit 0
Byte 0	Serial number MSB							
Byte 1	Serial number							
Byte 2	Serial number							
Byte 3	Serial number LSB							

e.g.: 148388723 = 08D83B73_{hex}

9.2.5.8 Function number 7: For internal use only.

9.2.5.9 Function number 8–11, 14: weight data (read)

The gross, net, and tare weight are stored as a DINT fix point. The real data value is derived from DINT and EXPO as follows:

$$\text{Value}_{\text{Real}} = \text{reading}_{\text{DINT}} \times 10^{(-\text{EXPO})}$$

Function number 8	Current gross value
Function number 9	Current net value, if tared; otherwise gross
Function number 10	Current tare value, if tared; otherwise 0
Function number 11	Current gross/net weight selected with bit 72.
Function number 14	max. capacity (Max)

9.2.5.10 Function number 24–29: Limit value (Read/Write)

Function number 24	Limit 1 on
Function number 25	Limit 1 off
Function number 26	Limit 2 on
Function number 27	Limit 2 off
Function number 28	Limit 3 on
Function number 29	Limit 3 off

9.2.5.11 Function number 30, 31: Fixed values (Read/Write)

Function number 30	Fixed value for analog output, value (num) 0 20000 corresponds to 20 mA
Function number 31	Fixed value for preset tare, see also SetFixTare , Get-FixTare in Chapter Data exchange range .

9.2.5.12 Function number 80–89: state-controlled action bits (write)

Note:

For setting bits, see Chapter [Writing bits](#) .

Only setting and resetting of single bits is possible.

When changing a bit from 0 to 1, the corresponding action starts. After handling the command, the bit must be reset. Application: The master writes cyclically.

The bit is set as **Write_Value_Select** with the specified number (see Chapter-[Writing bits](#)).

The bit is reset at the specified number +128.

Function number 80	SetZero	Set the gross weight to zero.
Function number 81	SetTare	The weighing point is tared.
Function number 82	ResetTare	Reset tare.
Function number 83	SetTest	Start the ADC test.
Function number 84	ResetTest	Finish the ADC test.
Function number 85	ResetPwf	Reset the PowerFail bit (function number 1; the bit was set after "power on").
Function number 86	SetFixTare	Taring with weight in numerical address D31 "FixTare".
Function number 87	GetFixTare	The current gross weight is copied to the numerical address D31.
Function number 89	ResetError	The CmdError error bit is reset.

9.2.5.13 Function number 112–121: transition-controlled action bits (write)

For setting bits, see Chapter [Writing bits](#) .

As soon as the bit has been set, it is reset internally and the process is carried out; this process is transition-controlled (for one write operation).

The bit is set as **Write_Value_Select** with the specified number (see Chapter-[Writing bits](#)).

Function number 112	SetZero
Function number 113	SetTare
Function number 114	ResetTare
Function number 115	SetTest
Function number 116	ResetTest
Function number 117	ResetPwf
Function number 118	SetFixTare (function number 86, see Chapter Function number 80–89: state-controlled action bits (write)).
Function number 119	GetFixTare (function number 87, see Chapter Function number 80–89: state-controlled action bits (write)).
Function number 121	ResetError

Note:

To prevent frequent writing to the EARAM, the write interval should be no shorter than 15 seconds.

9.2.6 Example: reading the gross weight

Input range (MOSI)

Byte	Value	Description
0		
1		
2		
3		
4	08	Read the gross weight (for function number 8, see Chapter Function number 8-11, 14: weight data (read))
5		
6		
7		

Output range (MISO)

Byte	Value								Description
0	00								Gross weight - byte 0 (MSB)
1	00								Gross weight - byte 1
2	04								Gross weight - byte 2
3	D2								Gross weight - byte 3 (LSB)
4	08								Gross weight request detected.
5	Write Active	Power Fail							In direct access, status bits are independent of the write or read request.
6	Cmd Busy	Cmd Error				Tare Active	Cal Changed	Test Active	
7	Out-Of range	Standstill	In-side ZSR	Center Zero	Be-low Zero	Over-load	Above Max	ADC Error	
	Bit 7	Bit 6	Bit 5	Bit 4	Bit 3	Bit 2	Bit 1	Bit 0	

The gross value (hex:000004D2 <=> 1234) can be read from bytes 0-3.

Negative values are output in the second complement.

9.2.7 Special note for DeviceNet and EtherNet/IP

With these fieldbus types, the sequence of the bytes (only applicable for words and individual bytes) is inverted.

With long words, this problem does not arise due to compensation by the firmware.

Sequence of data bytes 0-3:

Standard sequence		Sequence for Device-Net and EtherNet/IP	
Byte 0	Read data 0 (MSB)	Byte 0	Read data 3 (LSB)
Byte 1	Read data 1	Byte 1	Read data 2
Byte 2	Read data 2	Byte 2	Read data 1
Byte 3	Read data 3 (LSB)	Byte3	Read data 0 (MSB)

Consequently, the sequence on the PLC side must be changed when using the "DeviceNet" and "EtherNet/IP" fieldbus types.

10 SPM

10.1 General notes

The memory accessible to the user is the SPM (Scratch Pad Memory). This memory is used to store lots of internal data from which weights, statuses and reports can be read and control data can be written.

- System data are defined by the firmware and the respective application.
- The free user range can be used freely, for example, via the configuration of logical links.

The SPM table can be accessed via OPC and ModBus communication and fieldbus with SPM interface.

In addition, individual bits are copied back and forth between digital inputs and outputs and the SPM via the I/O configuration.

Note: If a text is defined e.g. from SPM address B401, this must be defined in the OPC server from SPM address B400 so that the content actually begins at B401.

10.2 Elementary data types

The elementary data types are characterized by their bit width and possible value range.

All commands of the data type BOOL are executed with a rising edge.

Data type	Description	Value range
BOOL	bool	0 (FALSE) or 1 (TRUE)
SINT	short integer	-128 to 127
INT	integer	-32768 to 32767
DINT	double integer	-2^{31} to $2^{31}-1$
LINT	long integer	-2^{63} to $2^{63}-1$
USINT	unsigned short integer	0 to 255
UINT	unsigned integer	0 to 65535
UDINT	unsigned double integer	0 to $2^{32}-1$
ULINT	unsigned long integer	0 to $2^{64}-1$

Data type	Description	Value range
REAL	real number	$\pm 1.18\text{E}-38$ bis $3.4\text{E}38$ (with approx. 7 significant digits)
LREAL	long real number	$\pm 1.18\text{E}-308$ bis $3.4\text{E}308$ (with approx. 16 significant digits)
TIME	time duration	1 ms to $\pm 2^{47}$ ms
DATE	date (only)	1.1.1900 to 31.12.2099
TIME_OF_DAY	time of day (only)	00:00:00.00 to 23:59:59.99
DATE_AND_TIME	Date and time of day	see DATE and TIME_OF_DAY
STRING	variable-long character string	max. 255 characters (ISO)
WSTRING	variable-long wide character string	max. 255 characters (Unicode)
BYTE	bit-sequence 8	...
WORD	bit-sequence 16	...
DWORD	bit-sequence 32	...
LWORD	bit-sequence 64	...

10.3 Addressing

The SPM table can be addressed via different counts. Bit addressing is used to count the individual bits (MX). Byte addressing is used to count individual bytes (MB), whereby, e.g. bits MX0–MX7 are identical to byte MB0.

Code	Data type	Address example
%ML	LWORD	L21
%MD	DINT	D42–43
%MW	WORD	W84–87
%MB	BYTE	B168–175
%MX	BOOL (bit)	X1344–1407

10.4 System data

SPM address	Data type	R/W	Function
X0-X2	BOOL	R	Digital input 1-3
X8-10	BOOL	R	Digital output 1-3
X16-18	BOOL	R	Output limit 1 1-3
B4	BYTE	R	Indicator status
X32	BOOL	R	ADC error
X33	BOOL	R	>Max (max. capacity; FSD = Full Scale Deflection)
X34	BOOL	R	>Max + permitted range (OVL)
X35	BOOL	R	<Zero
X36	BOOL	R	Zero $\pm\frac{1}{4}$ d
X37	BOOL	R	Within the zeroset range (ZSR)
X38	BOOL	R	The weight is stable
X39	BOOL	R	Weight <Zero or >Max (max. capacity; FSD = Full Scale Deflection)
B5	BYTE	R	ADC status
X40	BOOL	R	Measuring signal negative (Error 7)
X41	BOOL	R	Measuring signal >36 mV (Error 3)
X42	BOOL	R	Internal arithmetic error; CAL data are perhaps faulty (Error 1)
X43	BOOL	R	No or too low sense voltage (Error 6)
B6	BYTE	R	Command status
X48	BOOL	R	Command error
X49	BOOL	R	Command active
X50	BOOL	R	Network failure signal
B7	BYTE	R	Active status
X56	BOOL	R	Test mode active
X57	BOOL	R	Calibration active
X58	BOOL	R	Device is tared
X72	BOOL	R/W	Switch D11 to net weight.

SPM address	Data type	R/W	Function
X112	BOOL	W	Zero device.
X113	BOOL	W	Tare device
X114	BOOL	W	Reset the tare of the device
X115	BOOL	W	Start the test mode
X116	BOOL	W	Finish the test mode
X117	BOOL	W	Reset the power fail signal
X118	BOOL	W	Set fixed tare weight D31 as tare
X119	BOOL	W	Store the current gross weight in the preset tare memory (D31)
X121	BOOL	W	Reset error B19 = 0.
B16	SINT	R	Exponent Number of decimal places Example: 1.23 is displayed Exponent: 2
B17	SINT	R	Weight unit 1 = g, 2 = kg, 3 = t, 4 = lb
B18	SINT	R	Verification scale interval (for multi-interval/multi-range = d1 or e1)
B19	BYTE	R	Last weighing point error, see Chapter Error numbers @ "LAST_ERROR" .
B20	BYTE	R	Higher byte of product code (0x52)
B21	BYTE	R	Lower byte of product code (0x15)
B22	BYTE	R	Major part of version number (1.0)
B23	BYTE	R	Minor part of version number (1.0)
D6	UDINT	R	Serial number (board number)
D8	DINT	R	Current gross weight
D9	DINT	R	Current net weight
D10	DINT	R	Current tare weight

SPM address	Data type	R/W	Function
D11	DINT	R	Current gross/net weight selected with X72
D14	DINT	R	Max. weight (max. capacity; FSD = Full Scale Deflection)
D23	DINT	W	Activity counter, test of communication with device
D24	DINT	W	Limit 1 on
D25	DINT	W	Limit 1 off
D26	DINT	W	Limit 2 on
D27	DINT	W	Limit 2 off
D28	DINT	W	Limit 3 on
D29	DINT	W	Limit 3 off
D30	UDINT	W	Analog output for "transparent" mode
D31	DINT	W	Write value to fixed tare memory (X118, X119)

11 Error messages

11.1 Error messages measuring circuit

The internal weighing electronics can generate error messages, which are shown on the display.

Display	Error	Possible cause
ERR 2	The measuring signal is higher than Max + (x d) (Overload)	<ul style="list-style-type: none"> - Wrong setting. - Too much weight on the scale.
ERR 3	Measuring input open	<ul style="list-style-type: none"> - The measuring signal is higher than the permissible range of 36 mV. - Measuring cable is interrupted (cable break detection). - Other hardware defect.
ERR 6	No sense voltage	<ul style="list-style-type: none"> - Load cells not connected. - Sense line or supply line is interrupted. - Wrong polarity or sense voltage is low.
ERR 7	Negative measuring signal	<ul style="list-style-type: none"> - Wrong polarity of load cell signal. - Wrong polarity of load cell supply voltage.
ERR 9	The measuring signal is higher than the permissible range of 36 mV. Cannot read weight values from ADC (analog-digital converter).	Internal weighing point: <ul style="list-style-type: none"> - Error in weighing electronics board. - Defective load cell. - Cable break.

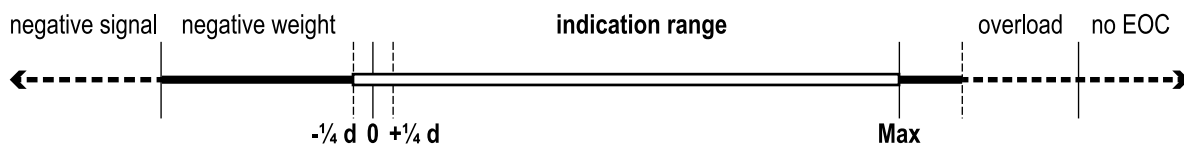

11.2 Error numbers @ "LAST_ERROR"

11.2.1 Weighing point error

Number	Display	Cause
6	test active	Test is active, no weights.
7	cal active	Adjustment is active, no weights.
8	no standstill	No standstill of the scale.
13	tare is active	Tare is active.
16	weight has error	Weight error.
18	cannot tare below zero	Taring below zero is not possible.
142	cal active	During adjustment, taring and zeroing is not possible.
147	no zeroset	Zeroset outside of the zero setting range is not possible.

12 Maintenance/repairs/cleaning

12.1 Maintenance

Maintenance work may only be carried out by authorized technical personnel with expert knowledge of the hazards involved and the required precautions.

Maintain and check the device regularly.

The periods must be determined by the operator, but should not exceed one year.

12.2 Repairs

Maintenance work may only be carried out by specialists:

- who have access to the necessary maintenance documents and instructions and
- who have attended appropriate training sessions.

Note: The seals placed on the device indicate that the device may only be opened and serviced by authorized specialists to ensure trouble-free and safe operation of the device, and to ensure that the warranty remains valid.

WARNING

Improper repairs can pose considerable risks to the user.



- ▶ Immediately disconnect a defective device from the power supply (disconnect the power plug from the electrical outlet).
- ▶ Repairs should only be performed by Minebea Intec authorized technical personnel using original spare parts.
- ▶ Defective or damaged cables or screw connections must be replaced as a complete unit.

WARNING

Working on a device that is switched on can have life-threatening consequences



- ▶ Do not open the analysis device while under power.
- ▶ Wait at least 10 seconds after disconnecting from the power supply before opening.
- ▶ The analysis device must be properly opened and closed because the fitting surfaces on the housing parts influence the IP protection.

12.3 Cleaning

12.3.1 Instructions for cleaning

The device must be cleaned of contaminants on a regular basis.

WARNING



Working on a device that is switched on can have life-threatening consequences.

- ▶ Disconnect the device from the power supply before cleaning (disconnect the power plug from the electrical outlet).

NOTICE

Property damage caused by unsuitable cleaning utensils/products.

Damage to the device.

- ▶ Prevent moisture from penetrating the interior.
- ▶ Do not use aggressive cleaning agents (solvents or similar agents).
- ▶ For use in the food industry, use a cleaning agent suitable for that particular working environment.
- ▶ Use soft sponges, brushes and cloths.
- ▶ Spraying with water or blowing off with compressed air is not permissible.

1. Unplug device from mains supply, disconnect any data cables.
2. Clean the device with a cloth lightly moistened with a soap solution.
3. Wipe down the device with a soft, dry cloth after cleaning.

13 Safety inspection

Information on safety inspection

Safe operation of the scale (weighing platform/weighing facility + weighing indicator) is no longer ensured,

- if there is visible damage to the connection cable.
 - if the weighing platform/weighing facility and weighing indicator no longer work.
 - after prolonged storage under unfavorable conditions.
 - after heavy transport stresses.
-
- ▶ Immediately disconnect the defective weighing platform/weighing facility and weighing indicator from the power supply (pull the power plug out of the socket) and secure them against further use.
 - ▶ Contact Minebea Intec customer service.

14 Disposal

Our products and their packaging should not be disposed of in municipal waste (e.g. garbage can for recyclable packaging, garbage can for paper packaging, etc.). They can either be recycled by the customer themselves, providing this complies with requirements set out by electrical or electronic waste or packaging waste laws, or sent back to Minebea Intec at a charge.

This option of returning the product is intended to provide proper recycling or reuse in a manner that is collected separately from municipal waste.

Before disposing of or scrapping the old products, any single-use or rechargeable batteries should be removed and taken to a suitable collection point. The type of battery used is specified in the technical data.

Please see our General Terms and Conditions for further information.

Service addresses for repair acceptance and collection points can be found on the product information enclosed with the product as well as on our website (www.minebea-intec.com).

Should you have any further questions, please contact your local service representative or our service center.

Minebea Intec GmbH
Repair center
Meiendorfer Strasse 205 A
22145 Hamburg, Germany
Phone: +49.40.67960.333
service.HH@minebea-intec.com

We reserve the right not to accept products that are contaminated with hazardous substances (ABC contamination).

15 Specification

15.1 Equipment supplied

Ser. no.	Name
1	Transmitter
2	Safety instructions 9499 059 40001

15.2 General technical data

The following characteristics are valid after a warm-up time of at least 60 minutes (reference temperature 23 °C).

15.2.1 Date/time buffer

The lithium battery as a buffer for the date/time chip and as a buffer for the supply voltage so the device can be switched on again.

Lifespan	Device continuously connected to mains voltage	up to 10 years
	Device not connected to mains voltage for some time (e.g. in storage)	up to 7 years

15.2.2 Touch Display

Type	Size	Display
TFT Color touch display	1.77"	128×160 pixels

15.2.3 Supply voltage connection version 24 V DC

Supply voltage	$U_{DC} = 24 \text{ V}$	+10/-15 %
Max. power consumption	9 W	

15.3 Effect of ambient conditions

15.3.1 Ambient conditions

Temperature range	
Ambient temperature for operation	-10...+55 °C
Power-on temperature	>0°C
Limits for storage/transport	-20...+70 °C
Humidity	<90 %, non-condensing (acc. to IEC 60068-2)
Protection class	IP20
Height	<2000 m
Vibrations	The device should not be exposed to strong vibrations.

15.3.2 Electromagnetic Compatibility (EMC)

All data in compliance with EN 61326 industrial section

Housing	High frequency electromagnetic fields (80...1000 MHz)	EN 61000-4-3	10 V/m
	High frequency electromagnetic fields (1.4...2.0 GHz)	EN 61000-4-3	3 V/m
	High frequency electromagnetic fields (2.0...2.7 GHz)	EN 61000-4-3	1 V/m
	Electrostatic discharge (ESD)	EN 61000-4-2	4/8 kV
Signal and control lines	Fast transients (burst)	EN 61000-4-4	1 kV
	Peak voltages (surge) 1.2 µs	EN 61000-4-5	1 kV
	Conducted disturbances by high frequency coupling (0.15...80 MHz)	EN 61000-4-6	3 V

Mains inputs	Fast transients (burst)	EN 61000-4-4	2 kV
	Peak voltages (surge) 1.2/50 μ s	EN 61000-4-5	1/2 kV
	Conducted disturbances by high frequency coupling (0.15... 80 MHz)	EN 61000-4-6	3 V

15.3.3 RF interference suppression

Electromagnetic emission



pursuant to EN 61326, Limit class A, for industrial areas

15.4 Weighing electronics data

15.4.1 Load cells

Load cell type	Strain gauge load cells	6 or 4-wire connection possible.
Supply voltage	$U_{DC} = 5 V$	<ul style="list-style-type: none"> - for $I_{max} = 66.6 mA$ - for max. 8 load cells, each with 650 Ω - 4 load cells, each with 350 Ω
Max. load	$\geq 75 \Omega$	

15.4.2 Principle

Principle	Direct current, Delta-Sigma converter, ratiometric to supply voltage
Conversion time/ measurement time	10, 20, 40, 80, 160, 320, 640 ms
Digital filter	Can be activated, active 4th order (low-pass) characteristics: Bessel, aperiodic, Butterworth, Tschebyscheff
Cut-off frequency	adjustable

15.4.3 Accuracy and stability

Accuracy*	$\leq 6,000$ d, acc. to OIML R76 Klasse III
Min. measuring signal *	6,000 d: 0.6 mV/V @ 5 V supply [0.5 μ V/d]
Linearity*	<0.01 %
Zero point stability error (TK ₀)*	<0.05 μ V/K RTI; ≤ 0.01 %/10 K at 1 mV/V
SPAN stability error (TK _{span})*	< ± 4.0 ppm/K

* at a measurement time of 160 ms.

15.4.4 Sensitivity

Sensitivity	0.5 μ V/d @ 6,000 d
Max. resolution	4.28 million internal steps at 20 mV
Measurement input (measuring signal + dead load)	U _{DC} = 0...max. 20 mV, symmetrical to zero

15.4.5 Connecting cables

Connection	PR no./cable type	Length
between junction box and device	PR 6135, PR 6135A	max. 500 m – length of the load cell cable

15.5 Mechanics

15.5.1 Housing

Material		Polyamide
Surface finish		Untreated
Color (RAL)		Light gray (7035)
UL 94 flammability class		V0
Dimensions		See Chapter Housing dimensions
Weights	Net weight	approx. 274 g
	Shipping weight	approx. 418 g

16 Appendix

16.1 Certificates

Ser. no.	Name	Document no.
1	EU Declaration of Conformity	MEU22001



EU-Declaration of Conformity

(in accordance with ISO/IEC 17050-1)

MEU22001 Rev. 1



1. Product model / product number / solely valid for project number:
 MiNexx Link E / PR 5215 / ----

2. Name and address of the manufacturer (2.1) and his authorized representative (2.2):
 - 2.1 Minebea Intec GmbH, Meiendorfer Straße 205 A, 22145 Hamburg, Germany
 - 2.2 /

3. This declaration of conformity is issued under the sole responsibility of the manufacturer.

4. Object(s) of the declaration:
 - 4.1 PR 5215/[00,01,04,05,06,07,08,10,11]

5. The object(s) of the declaration described above is in conformity with the relevant Union harmonization legislation:
 - (4.1)
 - 5.1 2014/30/EU (6.1)
 - 5.2 2011/65/EU (6.2)

6. References to the relevant harmonized standards used or references to the other technical specifications in relation to which conformity is declared:
 - 6.1 2014/30/EU EN 61326-1:2013
 - 6.2 2011/65/EU EN IEC 63000:2018

Minebea Intec GmbH
 Hamburg, 25. Aug. 2022

Dr. Karl Sommer
 COO

p.p.a.

Dr. Axel Böttger
 CTO

i.A.

Oliver Freitag
 CE Certification



EU-Declaration of Conformity

(in accordance with ISO/IEC 17050-1)

MEU22001 Rev. 1

Minebea
intec
The true measure

български (bg)

Декларация за съответствие

1. Модел на продукта / Номер на продукта / валидно само за номера на проекта:
2. Наименование и адрес на производителя (2.1) и на неговия упълномощен представител (2.2):
3. Настоящата декларация за съответствие е издадена на отговорността на производителя.
4. Предмет(и) на декларацията:
5. Предметът (ите) на декларацията, описан(и) по-горе отговаря(т) на съответното законодателство на Съюза за хармонизация:
6. Позоваване на използваните хармонизирани стандарти или позоваване на други технически спецификации, по отношение на които се декларира съответствие:

čeština (cs)

Prohlášení o shodě

1. Model výrobku / číslo výrobku / platné pouze pro číslo projektu:
2. Jméno a adresa výrobce (2.1) a jeho zplnomocněného zástupce (2.2):
3. Toto prohlášení o shodě se vydává na výhradní odpovědnost výrobce.
4. Předmět(y) prohlášení:
5. Výše popsaný předmět / Výše popsané předměty prohlášení je/ jsou ve shodě s příslušnými harmonizačními právními předpisy Unie:
6. Odkazy na příslušné harmonizované normy, které byly použity, nebo na jiné technické specifikace, na jejichž základě se shoda prohlašuje:

dansk (da)

Overensstemmelseserklæring

1. Produktmodel / produktnummer / gælder kun for projektnummer:
2. Fabrikantens (2.1) og dennes bemyndigede repræsentants (2.2) navn og adresse:
3. Denne overensstemmelseserklæring udstedes på fabrikantens ansvar.
4. Genstand(ene) for erklæringen:
5. Genstand(e) for erklæringen, som beskrevet ovenfor, er i overensstemmelse med den relevante EU-harmoniseringslovgivning:
6. Referencer til de relevante anvendte harmoniserede standarder eller til de andre tekniske specifikationer, som der erklæres overensstemmelse med:

Deutsch (de)

Konformitätserklärung

1. Produktmodell / Produktnummer / gilt ausschließlich für Projekt-Nr.:
2. Name und Anschrift des Herstellers (2.1) und seines Bevollmächtigten (2.2):
3. Die alleinige Verantwortung für die Ausstellung dieser Konformitätserklärung trägt der Hersteller.
4. Gegenstände der Erklärung:
5. Die oben beschriebenen Gegenstände der Erklärung erfüllen die einschlägigen Harmonisierungsrechtsvorschriften der Union:
6. Angabe der einschlägigen harmonisierten Normen oder der anderen technischen Spezifikationen, die der Konformitätserklärung zugrunde gelegt wurden:

Ελληνικά (el)

Δήλωση συμμόρφωσης

1. Μοντέλο προϊόντος / αριθμός προϊόντος / ισχύει μόνο για τον αριθμό του έργου:
2. Όνομα και διεύθυνση του κατασκευαστή (2.1) και του εξουσιοδοτημένου αντιπροσώπου του (2.2):
3. Η παρούσα δήλωση συμμόρφωσης εκδίδεται με αποκλειστική ευθύνη του κατασκευαστή.
4. Στόχος της δήλωσης:
5. Ο στόχος της δήλωσης που περιγράφεται παραπάνω είναι σύμφωνος με τη σχετική ενωσιακή νομοθεσία εναρμόνισης:
6. Παραπομπές στα σχετικά εναρμονισμένα πρότυπα που χρησιμοποιήθηκαν ή παραπομπές στις λοιπές τεχνικές προδιαγραφές σε σχέση με τις οποίες δηλώνεται η συμμόρφωση:

español (es)

Declaración de conformidad

1. Modelo de producto/número de producto / únicamente válido para el número de proyecto:2.
- Nombre y dirección del fabricante (2.1) y de su representante autorizado (2.2):
3. La presente declaración de conformidad se expide bajo la exclusiva responsabilidad del fabricante.
4. Objeto(s) de la declaración:
5. El/Los objeto(s) de la declaración descritos anteriormente son conformes con la legislación de armonización pertinente de la Unión Europea:
6. Referencias a las normas armonizadas pertinentes utilizadas o referencias a las otras especificaciones técnicas respecto a las cuales se declara la conformidad:



EU-Declaration of Conformity

(in accordance with ISO/IEC 17050-1)

MEU22001 Rev. 1



eesti keel (et)

Vastavusdeklaratsioon

1. Tootemudel / tootenumber / kehtib vaid järgmise projekti puhul:
2. Tootja nimi ja aadress (2.1) ning tema volitatud esindaja (2.2):
3. Käesolev vastavusdeklaratsioon on välja antud tootja ainuvastutusel.
4. Deklareeritav toode:
5. Ülal kirjeldatud deklareeritav toode on kooskõlas asjaomaste liidu ühtlustamisaktidega:
6. Viited kasutatud harmoneeritud standarditele või viited muudele tehnilistele spetsifikatsioonidele, millele vastavust deklareeritakse:

français (fr)

Déclaration de conformité

1. Modèle / numéro de produit / valable uniquement pour le numéro de projet:
2. Nom et adresse du fabricant (2.1) et de son mandataire (2.2) :
3. La présente déclaration de conformité est établie sous la seule responsabilité du fabricant.
4. Objet(s) de la déclaration :
5. Le ou les objets de la déclaration décrite ci-dessus est/sont conforme(s) à la législation d'harmonisation de l'Union applicable :
6. Références des normes harmonisées pertinentes appliquées ou des autres spécifications techniques par rapport auxquelles la conformité est déclarée :

hrvatski (hr)

Izjava o sukladnosti

1. Model proizvoda / broj proizvoda / vrijedi samo za broj projekta:
2. Naziv i adresa proizvođača (2.1) i njegovog ovlaštenog zastupnika (2.2):
3. Za izdavanje ove izjave o sukladnosti odgovoran je isključivo proizvođač.
4. Predmet(i) izjave:
5. Predmet(i) navedene izjave je/su u skladu s mjerodavnim zakonodavstvom Unije o uskladjivanju:
6. Pozivanja na relevantne primjenjene uskladene norme ili pozivanja na ostale tehničke specifikacije u vezi s kojima se izjavljuje sukladnost:

magyar (hu)

Megfelelőségi nyilatkozat

1. Termékmodell / termékszám / kizárólag az alábbi projektszámhoz érvényes:
2. A gyártó (2.1) vagy adott esetben meghatalmazott képviselőjének (2.2) neve és címe:
3. Ezt a megfelelőségi nyilatkozatot a gyártó kizárólagos felelőssége mellett adják ki.
4. A nyilatkozat tárgya(i):
5. A fent ismertetett nyilatkozat tárgya megfelel a vonatkozó uniós harmonizációs jogszabályoknak:
6. Az alkalmazott harmonizált szabványokra való hivatkozás vagy az azokra az egyéb műszaki leírásokra való hivatkozás, amelyekkel kapcsolatban megfelelőségi nyilatkozatot tettek:

italiano (it)

Dichiarazione di conformità

1. Modello di prodotto / numero di prodotto / valido unicamente per numero di progetto:
2. Nome e indirizzo del fabbricante (2.1) e del relativo rappresentante autorizzato (2.2):
3. La presente dichiarazione di conformità è rilasciata sotto la responsabilità esclusiva del fabbricante.
4. Oggetto/i della dichiarazione:
5. L'oggetto o gli oggetti della dichiarazione di cui sopra sono conformi alla pertinente normativa di armonizzazione dell'Unione:
6. Riferimento alle pertinenti norme armonizzate utilizzate o riferimenti alle altre specifiche tecniche in relazione alle quali è dichiarata la conformità:

Latvių kalba (lt)

Atitikties deklaracija

1. Gaminio modelis / gaminio numeris / galioja tik projekto numeriui:
2. Gamintojo (2.1) ir jo įgaliotojo atstovo (2.2) pavadinimas ir adresas:
3. Ši atitikties deklaracija išduota tik gamintojo atsakomybe.
4. Deklaracijos objektas (objektai):
5. Pirmiau aprašytas deklaracijos objektas (objektai) atitinka susijusius derinamuosius Sąjungos teisės aktus:
6. Susijusių taikytų darnųjų standartų nuorodos arba kitų techninių specifikacijų, pagal kurias buvo deklaruota atitikti, nuorodos:



EU-Declaration of Conformity

(in accordance with ISO/IEC 17050-1)

MEU22001 Rev. 1



latviešu valoda (lv)

Atbilstības deklarācija

1. Produkta modelis / produkta numurs / derīgs tikai projektam Nr.:
2. Ražotāja (2.1) un tā pilnvarotā pārstāvja (2.2.) nosaukums un adrese:
3. Šī atbilstības deklarācija ir izdota vienīgi uz ražotāja atbildību.
4. Deklarācijas priekšmets vai priekšmeti:
5. Iepriekš aprakstītais deklarācijas priekšmets vai priekšmeti atbilst attiecīgajam Savienības saskaņošanas tiesību aktam:
6. Atsauces uz attiecīgajiem izmantojamiem saskaņotajiem standartiem vai uz citām tehniskajām specifikācijām, attiecībā uz ko tiek deklarēta atbilstība:

malti (mt)

Dikjarazzjoni ta' konformità

1. Mudell tal-prodott / numru tal-prodott / validu biss għan-numru tal-proġett:
2. L-isem u l-indirizz tal-manifattur (2.1) u tar-rappreżentant awtorizzat tiegħu (2.2):
3. Din id-dikjarazzjoni ta' konformità tinhareġ taht ir-responsabbiltà unika tal-manifattur.
4. L-għan(t)iet tad-dikjarazzjoni:
5. L-għan(t)iet tad-dikjarazzjoni deskritt(i) hawn fuq huwa(huma) konformi mal-leġislazzjoni ta' armonizzazzjoni rilevanti tal-Unjoni:
6. Ir-referenzi għall-istandards armonizzati rilevanti li ntużaw, jew ir-referenzi għall-ispeċifikazzjonijiet tekniċi l-oħra li skonthom qed tiġi ddiġjarata l-konformità:

nederlands (nl)

Conformiteitsverklaring

1. Productmodel / productnummer / uitsluitend geldig voor projectnummer:
2. Naam en adres van de fabrikant (2.1) en zijn gemachtigde (2.2):
3. Deze conformiteitsverklaring wordt verstrekt onder volledige verantwoordelijkheid van de fabrikant.
4. Voorwerp(en) van de verklaring:
5. Het (de) hierboven beschreven voorwerp(en) is (zijn) in overeenstemming met de desbetreffende harmonisatiewetgeving van de Unie:
6. Vermelding van de toegepaste relevante geharmoniseerde normen of van de overige technische specificaties waarop de conformiteitsverklaring betrekking heeft:

polski (pl)

Deklaracja zgodności

1. Model produktu / numer produktu / ważny wyłącznie dla projektu o numerze:
2. Nazwa i adres producenta (2.1) oraz jego upoważnionego przedstawiciela (2.2):
3. Niniejsza deklaracja zgodności wydana zostaje na wyłączną odpowiedzialność producenta.
4. Przedmiot(-y) deklaracji:
5. Wymieniony powyżej przedmiot (lub przedmioty) niniejszej deklaracji jest zgodny z odnośnymi wymaganiami unijnego prawodawstwa harmonizacyjnego:
6. Odwołania do odnośnych norm zharmonizowanych, które zastosowano, lub do innych specyfikacji technicznych, w stosunku do których deklarowana jest zgodność:

português (pt)

Declaração de conformidade

1. Modelo do produto / número do produto / somente válido para o número de projeto:
2. Nome e endereço do fabricante (2.1) e do seu mandatário (2.2):
3. A presente declaração de conformidade é emitida sob a exclusiva responsabilidade do fabricante.
4. Objeto(s) da declaração:
5. O(s) objeto(s) da declaração acima descrito(s) está(ão) em conformidade com a legislação aplicável de harmonização da União:
6. Referências às normas harmonizadas aplicáveis utilizadas ou às outras especificações técnicas em relação às quais é declarada a conformidade:

română (ro)

Declarație de conformitate

1. Modelul de produs / Număr produs / valabil numai pentru numărul proiectului:
2. Denumirea și adresa producătorului (2.1) și a reprezentantului său autorizat (2.2):
3. Prezenta declarație de conformitate este emisă pe răspunderea exclusivă a producătorului.
4. Obiectul (obiectele) declarației:
5. Obiectul (obiectele) declarației descrise mai sus sunt în conformitate cu legislația relevantă de armonizare a Uniunii:
6. Trimiteri la standardele armonizate relevante folosite sau trimiteri la celelalte specificații tehnice în legătură cu care se declară conformitatea.



EU-Declaration of Conformity

(in accordance with ISO/IEC 17050-1)

MEU22001 Rev. 1



slovenčina (sk)

Vyhľadanie o zhode

1. Model výrobku / číslo výrobku / platné len pre číslo projektu;
2. Meno/názov a adresa výrobcu (2.1) a jeho splnomocneného zástupcu (2.2);
3. Toto vyhlásenie o zhode sa vydáva na vlastnú zodpovednosť výrobcu.
4. Predmet(-y) vyhlásenia:
5. Uvedený predmet či uvedené predmety vyhlásenia sú v zhode s príslušnými harmonizačnými právnymi predpismi Únie;
6. Odkazy na príslušné použité harmonizované normy alebo odkazy na iné technické špecifikácie, v súvislosti s ktorými sa zhoda vyhlasuje;

slovenščina (sl)

Izjava o skladnosti

1. Model proizvoda / serijska številka proizvoda / veljavno samo za številko projekta;
2. Ime in naslov proizvajalca (2.1) ter njegovega pooblaščenega zastopnika (2.2);
3. Za izdajo te izjave o skladnosti je odgovoren izključno proizvajalec.
4. Predmet(i) izjave:
5. Predmet(i) navedene izjave je (so) v skladu z ustrežno zakonodajo Unije o harmonizaciji;
6. Sklicevanja na uporabljene ustrezne harmonizirane standarde ali sklicevanja na druge tehnične špecifikacije v zvezi s skladnostjo, ki je navedena v izjavi;

suomi (fi)

Vaatumustenmukaisuusvakuutus

1. Tuotemalli / tuotenumero / koskee vain projektinumeroa;
2. Valmistajan (2.1) ja valtuutetun edustajan (2.2) nimi ja osoite;
3. Tämä vaatimustenmukaisuusvakuutus on annettu valmistajan yksinomaisella vastuulla.
4. Vakuutuksen kohde (kohteet):
5. Edellä kuvattu (kuvatut) vakuutuksen kohde (kohteet) on (ovat) asiaa koskevan unionin yhdenmukaistamislainsäädännön vaatimusten mukainen (mukaisia);
6. Viittaus niihin asiaa koskeviin yhdenmukaistettuihin standardeihin, joita on käytetty, tai viittaus muihin teknisiin eritelmiin, joiden perusteella vaatimustenmukaisuusvakuutus on annettu;

svenska (sv)

Försäkran om överensstämmelse

1. Produktmodell / produktnummer / gäller endast för projektnummer;
2. Tillverkarens namn och adress (2.1) och dess auktoriserade representant (2.2);
3. Denna försäkran om överensstämmelse utfärdas på tillverkarens eget ansvar.
4. Föremål för försäkran:
5. Föremålet/föremålen för försäkran ovan överensstämmer med den relevanta harmoniserade unionslagstiftningen;
6. Hänvisningar till de relevanta harmoniserade standarder som använts eller hänvisningar till de andra tekniska specifikationer enligt vilka överensstämmelsen försäkras;

Published by
Minebea Intec GmbH
Meiendorfer Strasse 205 A | 22145 Hamburg, Germany
Phone: +49.40.67960.303 | Email: info@minebea-intec.com
www.minebea-intec.com

