

**Operating Instructions**

**Compact scale Puro® - Basic**



## **Foreword**

### **Must be followed!**

Any information in this document is subject to change without notice and does not represent a commitment on the part of Minebea Intec unless legally prescribed. This product should only be operated/installed by trained and qualified personnel. In correspondence concerning this product, the type, name, and release number/serial number as well as all license numbers relating to the product have to be cited.

### **Note**

This document is partially protected by copyright. It may not be changed or copied, and it may not be used without purchasing or written permission from the copyright owner (Minebea Intec). The use of this product constitutes acceptance by you of the abovementioned provisions.

## Table of contents

<b>1</b>	<b>Introduction.....</b>	<b>3</b>
1.1	Read the manual.....	3
1.2	This is what operating instructions look like.....	3
1.3	This is what lists look like.....	3
1.4	This is what menu items and softkeys look like.....	3
1.5	This is what the safety instructions look like.....	3
<b>2</b>	<b>Safety instructions.....</b>	<b>5</b>
2.1	General information.....	5
2.2	Incoming goods inspection.....	5
2.3	Before operational startup.....	5
2.3.1	Danger of explosion.....	5
2.3.2	IP protection.....	5
2.3.3	Storage and transport conditions.....	6
2.4	Failure and excessive stresses.....	6
<b>3</b>	<b>Device installation.....</b>	<b>7</b>
3.1	Mechanical preparation.....	7
3.1.1	Ambient conditions.....	7
3.1.2	Installation location.....	7
3.1.3	Unpacking.....	7
3.1.4	Checking the equipment supplied.....	7
3.1.5	Leveling the weighing platform.....	8
3.1.6	Acclimatizing the device.....	8
3.2	Connection.....	8
3.2.1	Power supply.....	8
3.2.2	Connecting a printer.....	9
<b>4</b>	<b>Device description.....</b>	<b>10</b>
4.1	Display and operating elements.....	10
4.1.1	Overview.....	10
4.1.2	Display elements.....	10
4.1.3	Operating elements.....	11
4.1.4	Display on the reverse.....	12
<b>5</b>	<b>Operating.....</b>	<b>13</b>
5.1	Basic functions.....	13
5.1.1	Switching on the device.....	13
5.1.2	Switching off the device.....	13
5.1.3	Adjusting the GEO setting.....	13
5.1.4	Increment d.....	13

---

5.1.5	Select application program .....	13
5.2	Application programs .....	14
5.2.1	Weighing application .....	14
5.2.2	Totalizing application and statistics mode .....	16
5.3	Menu .....	20
5.3.1	Accessing the menu .....	20
5.3.2	Menu navigation .....	22
5.4	Calibration and adjustment .....	28
5.4.1	[CAL] calibration .....	28
5.4.2	[LIN] linearization .....	31
5.4.3	[GEO] geographic data (calibration location) .....	34
5.4.4	GEO code table .....	35
5.5	SBI interface .....	37
<b>6</b>	<b>Maintenance/repairs/cleaning .....</b>	<b>39</b>
6.1	Repairs .....	39
6.2	Cleaning .....	39
6.2.1	Instructions for cleaning .....	39
6.2.2	Cleaning agents .....	39
<b>7</b>	<b>Waste disposal policy .....</b>	<b>40</b>
<b>8</b>	<b>Error correction .....</b>	<b>41</b>
8.1	Service information .....	42
<b>9</b>	<b>Technical data .....</b>	<b>43</b>
9.1	Specification .....	43
9.2	Accessories .....	44
9.3	Dimensions .....	45
<b>10</b>	<b>Appendix .....</b>	<b>55</b>
10.1	Printouts .....	55
10.2	FCC notice .....	55

# 1 Introduction

## 1.1 Read the manual

- Please read this manual carefully and completely before using the product.
- This manual is part of the product. Keep it in a safe and easily accessible location.

## 1.2 This is what operating instructions look like

1. - n. are placed before steps that must be done in sequence.
  - ▶ is placed before a step.
  - ▷ describes the result of a step.

## 1.3 This is what lists look like

- indicates an item in a list.

## 1.4 This is what menu items and softkeys look like

[ ] frame menu items and softkeys.

**Example:**

[Start]- [Applications]- [Excel]

## 1.5 This is what the safety instructions look like

Signal words indicate the severity of the danger involved when measures for preventing hazards are not followed.

### **DANGER**

#### **Warning of personal injury**

DANGER indicates death or severe, irreversible personal injury which will occur if the corresponding safety measures are not observed.

- ▶ Take the corresponding safety precautions.

### **WARNING**

#### **Warning of hazardous area and/or personal injury**

WARNING indicates that death or severe, irreversible injury may occur if appropriate safety measures are not observed.

- ▶ Take the corresponding safety precautions.

### **CAUTION**

#### **Warning of personal injury.**

CAUTION indicates that minor, reversible injury may occur if appropriate safety measures are not observed.

- ▶ Take the corresponding safety precautions.

**NOTICE****Warning of damage to property and/or the environment.**

NOTICE indicates that damage to property and/or the environment may occur if appropriate safety measures are not observed.

- ▶ Take the corresponding safety precautions.
- 

**Note:**

User tips, useful information, and notes.

---

## 2 Safety instructions

### 2.1 General information

- The device may only be used as intended for weighing tasks.
- Observe the operating limits of the device.
- Do not apply loads that exceed the capacity of the scale.
- The voltage rating printed on the power supply (see type plate) must be the same as the local line voltage.
- Before connecting or disconnecting electronic peripheral devices, disconnect the device from the mains or from the data interface.
- Unplug the power cord from the mains supply before cleaning.
- Make sure that no liquid enters the device.
- The device may only be opened by authorized technicians.

### 2.2 Incoming goods inspection

Check the contents of the consignment for integrity. Check the contents visually to determine whether any damage has occurred during transport. If there are grounds for rejection of the goods, a claim must be filed with the carrier immediately. A Minebea Intec sales or service organization must also be notified. Visit our website <http://www.puroscales.com> or contact your dealer.

### 2.3 Before operational startup

#### **NOTICE**

#### **Perform visual inspection.**

Before operational startup as well as after storage or transport, inspect the product visually for signs of mechanical damage.

- The product should not be put into operation if it displays signs of visible damage and/or is defective.

#### 2.3.1 Danger of explosion

Do not use the device in hazardous areas.

#### 2.3.2 IP protection

All models fulfill protection grade IP43.

### 2.3.3 Storage and transport conditions

**NOTICE****Material damage is possible.**

Unpacked devices may lose their precision due to strong vibrations; strong vibrations may impair the safety of the device.

- ▶ Do not subject the device to extreme temperatures, moisture, shocks, and vibrations.
- 

### 2.4 Failure and excessive stresses

If the device or the power cord display visible damage: Disconnect the power supply and secure the device to prevent it being used further.

Do not unnecessarily subject the device to extreme temperatures, corrosive chemical vapors, moisture, shocks, and vibrations.

Extreme electromagnetic influences can affect the display value. Once the disturbance has ceased, the product can be used again as intended.



## 3 Device installation

### 3.1 Mechanical preparation

#### 3.1.1 Ambient conditions

- Only use within buildings.
- Operating temperature: -10°C to +40°C
- Storage temperature: -20°C to +50°C
- Relative humidity: 20% to 85%, non-condensing
- Altitude: up to 3,575 m

#### 3.1.2 Installation location

- Place the device on a stable, flat surface.
- Position the device so that the power plug is freely accessible and the power cord does not present an obstacle or trip hazard.

Avoid unsuitable influences at the installation location:

- Extreme temperatures and excessive temperature fluctuations
- Heat due to proximity to heaters or due to direct sunlight
- Aggressive chemical vapors
- Extreme moisture
- Extreme vibrations

#### 3.1.2.1 Shock resistance

##### **NOTICE**

**Falling objects, side impacts, and shock loads may affect the performance and the accuracy of the scale and damage the platform.**

- ▶ Avoid shock loads!

#### 3.1.3 Unpacking

- ▶ Unpack the device and check it for visible external damage.
  - ▷ If there is damage, follow the instructions in the chapter "Safety check".
- ▶ Keep the original packaging in case the device needs to be returned. Remove all cables before sending.

#### 3.1.4 Checking the equipment supplied

- 1 scale
- 1 load plate
- 1 USB power supply with cable
- Safety instructions and QR code for access to the complete documentation

### 3.1.5 Leveling the weighing platform

To achieve reproducible weighing results at all times, the weighing platform must be set up to be precisely horizontal.

Therefore the weighing platform must be re-leveled every time it is moved to a different location.

#### Leveling the weighing platform

- ▶ Use the adjustable feet to align the weighing platform so that the air bubble of the level indicator is in the center of the circle.
- ▶ Check that all four of the adjustable feet are touching the surface.
  - ▷ The weight of the platform must be spread equally across the adjustable feet.
- ▶ Adjust the adjustable feet: Retract the adjustable feet (clockwise) in order to lift the scale. Extend the adjustable feet (counter-clockwise) in order to lower the scale.

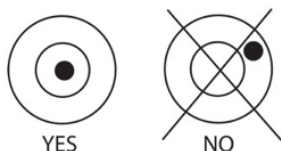

### 3.1.6 Acclimatizing the device

If a cold device is brought into a warm environment, condensation may form.

- ▶ Keep the device disconnected from the mains and allow it to acclimatize at room temperature for approx. two hours.

## 3.2 Connection

### 3.2.1 Power supply

AC power is used to power the scale when battery power is not needed.

Plug the USB-C plug into the USB-C jack on the bottom of the unit, then plug the AC power supply into a wall outlet.

---

**Note:**

Do not use the USB-C power supply cable for the PC communication. Instead use a standard USB-C cable.

---





#### 3.2.1.1 Battery power

The scale can be operated immediately with the power supply. In order to operate the scale with the battery, the battery should first be charged for 12 hours. If there is a power outage or if the power cord is disconnected, the scale switches into battery operation automatically. In the event of supply via a power supply, the battery is constantly charged meaning that the battery charging display (see Chapter [4.1.2](#)) is continuously illuminated. The scale can be used during the charging process; the battery is protected against excess charging.

When the device is switched on, the battery status LED illuminates in red while the battery is charging, and it goes green when the battery is fully charged.

The battery must be charged in a dry environment. For a maximum operating time, the battery should be charged at room temperature.

During battery operation, the battery icon displays the battery's remaining charge status. The display switches off automatically when the batteries are empty.

Icon	Charge status
	0 to 10% remaining
	11 to 40% remaining
	41 to 70% remaining
	71 to 100% remaining

---

**Note:**

If the battery icon flashes rapidly, then there is around 30 minutes of working time left. When [lo.bat] is displayed, the scale switches off.

---

**⚠ WARNING**

**Danger of explosion**

If the rechargeable battery is replaced with a battery of the wrong type, or if it is not connected correctly, then there is a danger of explosion.

- ▶ The battery may only be replaced with the same type by an authorized Puro® service dealer.
  - ▶ The battery must be disposed of according to the locally valid laws and regulations.
- 

### 3.2.2 Connecting a printer

A printer can be connected via the printer port on the underside of the device.

## 4 Device description

### 4.1 Display and operating elements

#### 4.1.1 Overview

Control panel (front) with LCD display.



No.	Description
1	Display elements, see Chapter 4.1.2.
2	Operating elements, see Chapter 4.1.3.

#### 4.1.2 Display elements

LCD display

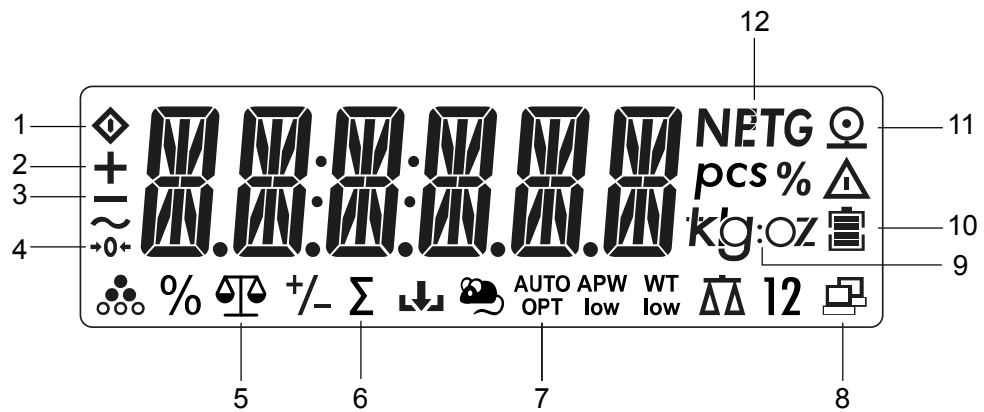

Item	Description	Item	Description
1	Busy	7	Scale tares automatically
2	Plus sign	8	Active data transmission
3	Minus sign	9	Selected weight unit
4	1/4 d range around zero	10	Battery charging
5	Weighing application active	11	Printer icon
6	Totalizing application active	12	Tare active, tare value is displayed

**LED displays**





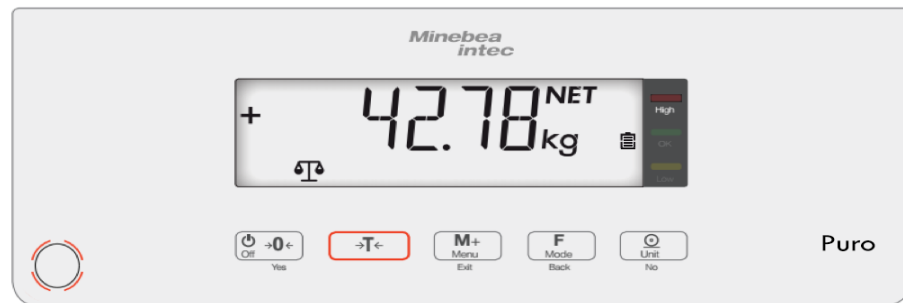

The battery status LED (1)

- Illuminates red while the battery is being charged
- Illuminates green if the battery is fully charged.

**4.1.3 Operating elements**



Key					
Primary function	On/Zero	Tare	M+	Function	Print
(Brief press) < 1 second	Switch on the scale (if the scale is switched off). Zero scale (if the scale is switched on).	Set tare	Totalizing Display weight or totalized values.	Call up applications	Send the current value to the selected COM ports if the "Out" option is specified for automatic printing.
Secondary Function	Off		Menu	Mode	Unit
(Extended press) > 2 seconds	Switch off the scale	Delete function for totalizing.	Accessing the menu		Changing the weight unit.
Menu function	Yes (Confirm)		Exit	Back	No (Reject)

Key					
(Brief press) < 1 second	Confirm display.	Exit menu. Cancel calibration process. Go to the previous digit.	Go to the previous menu items. Reduce digit value.	Discard current setting in the display and switch to the next available setting. Go to the next menu item. Increase digit value.	

#### 4.1.4 Display on the reverse

The LargeTall (LT) and SmallTall (ST) models have an additional display on the reverse, which displays the same elements as the display on the front. (See Chapter [4.1.2](#)).



## 5 Operating

### 5.1 Basic functions

#### 5.1.1 Switching on the device

- ▶ Press the  key.
- ▷ Whenever it is switched on, the device performs a self-test. This will display all display segments for a few seconds.

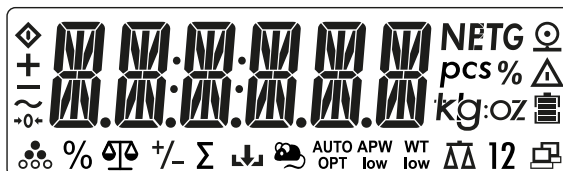

Then the software version number is briefly displayed.

If the scale is switched on for the first time, the weighing and totalizing (manual) applications are active.

#### 5.1.2 Switching off the device

- ▶ Press and hold the  key until [OFF] is displayed.
- ▷ [- OFF -] is displayed briefly in the display.

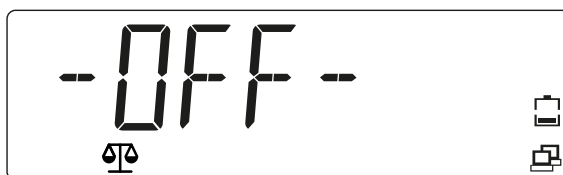

The device switches off, the display goes dark.

#### 5.1.3 Adjusting the GEO setting

Adjust the GEO setting according to the location in order to guarantee accurate weighing results. See Chapter [5.4.3](#).

#### 5.1.4 Increment d

"d" stands for the lowest weight value that can be displayed.

Example  $d = 0.02 \text{ g} \rightarrow 2 d = 0.04 \text{ g} \rightarrow 3 d = 0.06 \text{ g}$

#### 5.1.5 Select application program

- ▷ The Totalizing, Automatic Tare, and Automatic Printing applications can be activated in the menu.

[OP.FUNC]	
[A.TARE]	Automatic tare
[TOT.SET]	Totalizing
[PRINT]	
[A.PRINT]	Automatic printout

## 5.2 Application programs

### 5.2.1 Weighing application

1. The Weighing application is always active and is displayed with the application icon  at the lower edge of the screen.

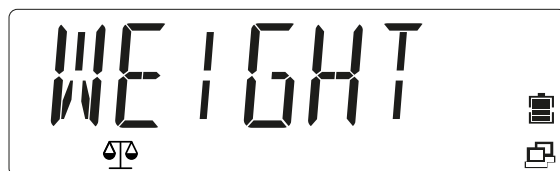

- ▷ [0.000] is shown.



2. Place the sample on the load plate (in this example: 0.598 kg).

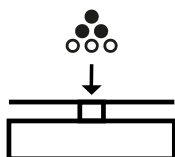

- ▷ The weight of the sample is displayed with the unit symbol (here [kg]).



#### 5.2.1.1 Set tare

- ▶ Place the empty container on the load plate.

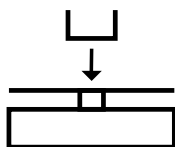

- ▷ The tare weight of the container is displayed:



- ▶ Press the  (Tare) key to save the tare weight.
- ▷ [0.000 kg] and [NET] (net value) is displayed:



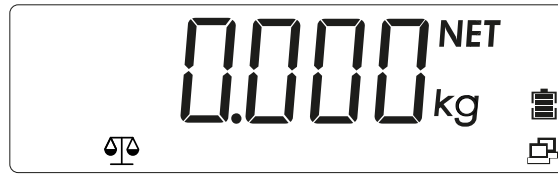

The scale has been tared. The tare weight remains saved until it is deleted or overwritten with a new weight.

### 5.2.1.2 Weight unit

The weight value can be displayed in various weight units:

[kg / g / lb / oz / lb:oz]

Select weight unit:

- ▶ Press the  (unit) key until the desired weight unit is displayed. Release the key to activate the weight unit.

Possible units are:

Weight unit	Unit symbol
Gram	[g]
Kilogram	[kg]
Pound	[lb]
Ounce	[oz]
Pound-ounce	[lb:oz]

#### Note:

Weight units must be activated in the menu in order to be able to be called up via the  (unit) key. See Chapter [5.3.2.3](#).

### 5.2.1.3 Stable weight value

A stable weight value is displayed with the unit symbols (e.g. [kg]).

Stable weight value:



A non-stable weight value is displayed without the unit symbols.

Non-stable weight value:

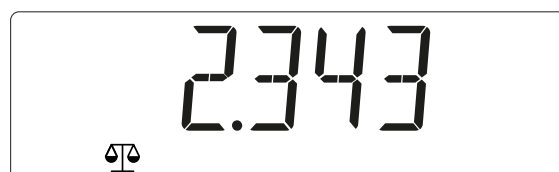

### 5.2.1.4 Negative weight value

A negative stable net weight value is displayed with the unit symbols (e.g. [kg]):



A negative (stable or unstable) gross weight value is displayed without unit symbols:



If the gross weight 20 d is below zero, [L] is displayed.

If the gross weight 7 d is above the max. capacity, [H] is displayed.

## 5.2.2 Totalizing application and statistics mode

With the Totalizing application, it is possible to manually or automatically add together values in the totalizing memory. In addition to the total, the number of items totalized is also saved.

Statistics data (total value, minimum/maximum weight, and total weighed objects) are saved for testing and printing. The totalizing function is available in every application. Manual totalizing is activated as standard.

### 5.2.2.1 Setting up the Totalizing application



1. To access the menu mode, press and hold the  key until [M.E.N.U] is displayed.



Release the key.

- ▷ The first menu item [APPLIC] (application) is shown in the display.







2. Press the  (No) key in order to access the next menu item, or press the  key to access the previous menu item.
3. Repeat until [OP.FUNC] (operating function) is shown in the display.



4. Press the  (Yes) key to access the sub-menu item.
5. Repeat until [TOT.SET] (Totalizing) is displayed.



6. Press the  (Yes) key to access the sub-menu, then use the  key to select one of the options [OFF / AUTO / MAN] (off/automatic/manual) and save the selection using the  (Yes) key.
7. Press the  key to exit the menu.

### 5.2.2.2 Totalizing weight values

The Totalizing application is activated when the  $\Sigma$  icon is displayed.



1. Place the first weight on the scale.

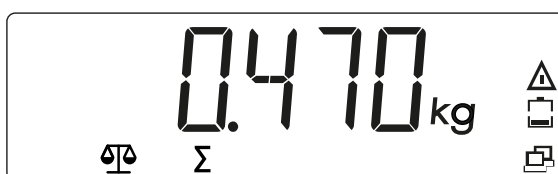
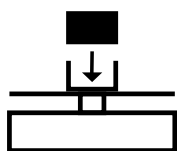

2. Press the  key to add the weight to the totalized data (manual mode).

OR

The weight value is automatically added to the totalized data as soon as the measured value is stable (automatic mode).

The  $\Sigma$  icon flashes until the weight is removed.

3. Empty the load plate.

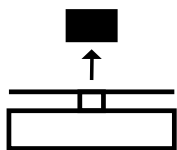

The weight must be removed from the load plate in order for the next weight to be able to be added to the totalized data.



- Place another weight on the scale and repeat the process (automatic or manual mode).

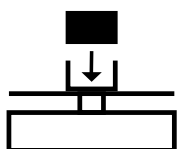

- ▷ The  $\Sigma$  icon flashes until the weight is removed.

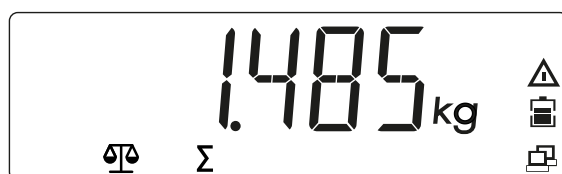

### 5.2.2.3 Displaying and deleting statistics data

Requirement: In order to display saved statistics, there must not be a load on the scale.

- Empty the load plate.

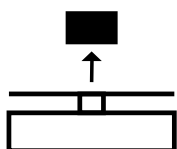

- Press the **M+** Menu key in order to display the saved totalized data.

The statistics information is displayed in the display in the following order:

Number of weighings carried out (N = 7):

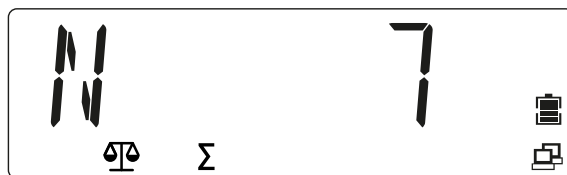

Totalized value (total = 5.225 kg)

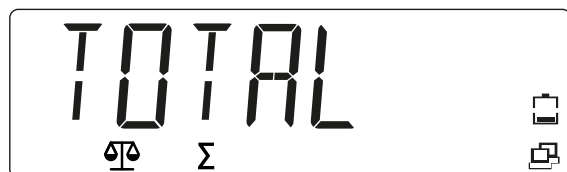

Minimum value (min = 0.470 kg):

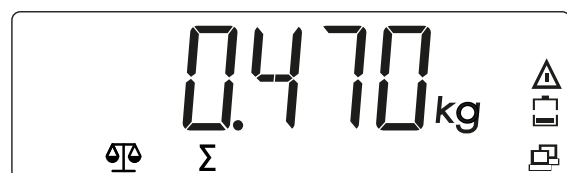
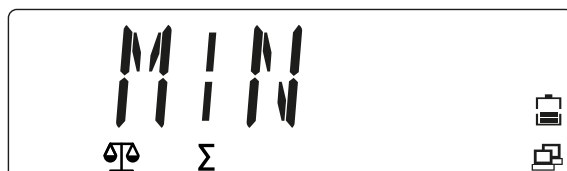

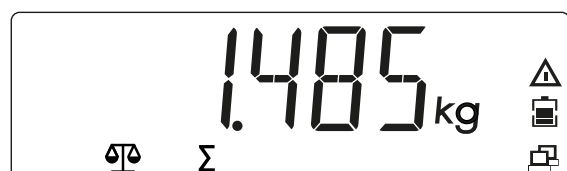
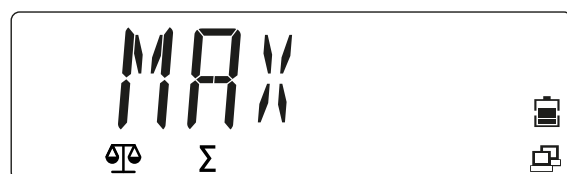

Maximum value (max = 1.485 kg)



Deleting the totalizing memory:

3. Press and hold the  key while there is no load on the load plate and the totalized data are displayed.
  - ▷ The message [CLR.TOT] is displayed.



4. To confirm the message, press the  (Yes) key; to cancel the process, press the  (No) key.

Check whether the totalizing memory has been deleted:

5. Press the  key in order to display the statistics information.

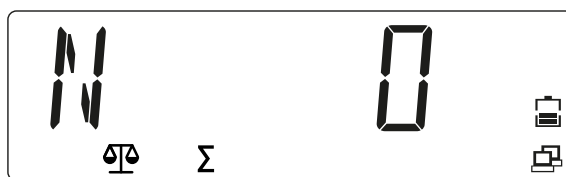

---

**Note:**

- The object must be removed from the load plate in order for the next weight to be able to be added to the totalized data.
  - Only stable weights are saved.
  - When calling up another application, the totalizing memory is deleted.
  - Gross weights and net weights cannot be added to the same total.
    - If the first weight is a gross weight, the following weights must also be gross weights.
    - If the first weight is a net weight, the following weights must also be net weights.
- 

## 5.3 Menu

The scale settings can be adjusted in the user menu (menu mode).

---

**Note:**

If appropriate interface options are installed, additional sub-menus may be available. Information on this can be found in the manual for the interface used.

---

### 5.3.1 Accessing the menu

1. Press and hold the  key until [M.E.N.U] is displayed.





Release the key.

- ▷ The first menu item [APPLIC] (application) is shown in the display.



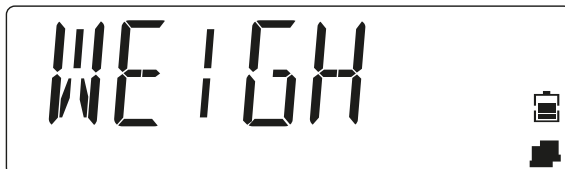

2. To call up a menu item (in this example [APPLIC]- [WEIGH]), press the  (Yes) key.



3. Or: Press the  key in order to go to the next menu item, or press the  key to go to the previous menu item.

- ▷ The second menu item [METRO] is shown in the display.





4. When the setting is displayed (in this example [METRO]- [STAB.RA] value 0.5 d), press the  (Yes) key in order to adopt the setting, or the  (No) key in order to change the setting. The current selection is marked with [◦].



5. When [END] is displayed, press the  (Yes) key in order to return to the options from the sub-menu.



6. Press the  (No) key to return to the first item in the current menu.  
7. Press the  key to exit the menu.

## 5.3.2 Menu navigation

Overview of the options of the menu mode:

— <b>APPLIC</b>	Application (see Chapter <a href="#">5.3.2.1</a> )
— <b>METRO</b>	Metrology (see Chapter <a href="#">5.3.2.2</a> )
— <b>UNIT</b>	Weight units (see Chapter <a href="#">5.3.2.3</a> )
— <b>OP.FUNC</b>	Operating functions (see Chapter <a href="#">5.3.2.4</a> )
— <b>PRINT</b>	Printer outputs (see Chapter <a href="#">5.3.2.5</a> )
— <b>PRN.COM</b>	Printer port communication (see Chapter <a href="#">5.3.2.6</a> )
— <b>PC.OUT</b>	PC output (see Chapter <a href="#">5.3.2.7</a> )
— <b>PC.COM</b>	PC port communication (see Chapter <a href="#">5.3.2.8</a> )
— <b>CAL.ADJ</b>	Calibration/adjustment (see Chapter <a href="#">5.3.2.9</a> )
— <b>INFO</b>	Info (display of serial number and type designation)
— <b>SECURE</b>	Block menu items (see Chapter <a href="#">5.3.2.11</a> )
— <b>E.N.D.</b>	Exiting menus

---

### Note:

Some applications and units are not available in all models.

---

### 5.3.2.1 [APPLIC] menu selection

The application to be used can be selected in this menu.

Only activated applications can be called up using the  (mode) key.

Factory settings are marked with "\*"

<b>APPLIC</b>	
— <b>WEIGH</b>	Weighing
<b>ON</b>	activated*
— <b>RESET</b>	Factory settings
<b>NO</b>	not reset*
<b>YES</b>	activated
— <b>END</b>	Exit menu level

### 5.3.2.2 [METRO] menu selection

The functions of the displays and scales can be adjusted in this menu.

Factory settings are marked with "\*"

<b>METRO</b>	
— <b>STAB.RA</b>	Stability range
<b>0.5d</b>	1/2 d
<b>1d</b>	1 d*
<b>2d</b>	2 d
<b>4d</b>	4 d
— <b>FILTER</b>	Adjustment filter
<b>LOW</b>	Lower accuracy, short stabilization time
<b>MED</b>	Normal accuracy, average stabilization time*
<b>HI</b>	High accuracy, long stabilization time
— <b>A.ZERO.T</b>	Automatic zero point correction
<b>OFF</b>	Switching off
<b>0.5d</b>	Drift up to 1/2 d*



—	1d	Drift up to 1 d
—	3d	Drift up to 3 d
—	<b>AUT.OFF</b>	Counter for automatic switching off
—	OFF	Switching off*
—	1 MIN	Switching off after 1 minute with no activity
—	5 MIN	Switching off after 5 minutes with no activity
—	10 MIN	Switching off after 10 minutes with no activity
—	<b>DYN.TIM</b>	No effect in this device
—	5 SEC	No effect in this device
—	10 SEC	No effect in this device
—	15 SEC	No effect in this device
—	20 SEC	No effect in this device
—	25 SEC	No effect in this device
—	30 SEC	No effect in this device
—	<b>RESET</b>	Factory settings
—	NO	not reset*
—	YES	activated
—	<b>END</b>	Exit menu level

### 5.3.2.3 [UNIT] menu selection

The weight unit can be selected in this menu.

Factory settings are marked with "\*"

<b>UNIT</b>		
—	kg	Kilogram
—	OFF	deactivated
—	ON	activated*
—	g	Gram
—	OFF	deactivated
—	ON	activated*
—	lb	Pound
—	OFF	deactivated
—	ON	activated*
—	oz	Ounce
—	OFF	deactivated
—	ON	activated*
—	lb:oz	Pound:ounce
—	OFF	deactivated*
—	ON	activated
—	<b>RESET</b>	Factory settings
—	NO	not reset*
—	YES	activated
—	<b>END</b>	Exit menu level

### 5.3.2.4 [OP.FUNC] menu selection

The scale parameters can be specified in this menu.

Factory settings are marked with "\*"

<b>OP.FUNC</b>		
—	<b>ZERO.R</b>	Zero range
—	2%	2% max. load
—	10%	10% max. load*
—	<b>A.TARE</b>	Automatic tare

<ul style="list-style-type: none"> <li>— OFF</li> <li>— ON</li> <li>— ON-ACC</li> <li>— BEEP.SI</li> <li>— OFF</li> <li>— ACCEPT</li> <li>— UNDER</li> <li>— OVER</li> <li>— UNDOVR</li> <li>— BEEP.KE</li> <li>— OFF</li> <li>— ON</li> <li>— TOT.SET</li> <li>— OFF</li> <li>— AUTO</li> <li>— MAN</li> <li>— LIGHT.T</li> <li>— 3 SEC</li> <li>— 5 SEC</li> <li>— 8 SEC</li> <li>— D.LIGHT</li> <li>— OFF</li> <li>— ON</li> <li>— AUTO</li> <li>— COM.EQU</li> <li>— OFF</li> <li>— BLUE.TH</li> <li>— WIFI</li> <li>— ETHER.N</li> <li>— RESET</li> <li>— NO</li> <li>— YES</li> <li>— END</li> </ul>	<ul style="list-style-type: none"> <li>deactivated*</li> <li>1st stable weight is tared</li> <li>No effect in this device</li> <li>Signal (in the Checking application)</li> <li>deactivated*</li> <li>No effect in this device</li> <li>No effect in this device</li> <li>No effect in this device</li> <li>No effect in this device</li> <li>Key tone</li> <li>deactivated</li> <li>activated*</li> <li>Totalizing setting</li> <li>deactivated</li> <li>Automatic totalizing</li> <li>Manual totalizing*</li> <li>Duration of the background lighting (D.LIGHT = AUTO)</li> <li>Switching off of the background lighting after 3 seconds with no activity</li> <li>Switching off of the background lighting after 5 seconds with no activity*</li> <li>Switching off of the background lighting after 8 seconds with no activity</li> <li>Background lighting of the display</li> <li>deactivated</li> <li>activated</li> <li>Switches on when a key is pressed or the displayed weight changes*</li> <li>Communication module</li> <li>deactivated*</li> <li>Bluetooth activated (if the Bluetooth module is installed)</li> <li>WiFi activated (if the WiFi module is installed)</li> <li>Ethernet activated (if the Ethernet module is installed)</li> <li>Factory settings</li> <li>not reset*</li> <li>activated</li> <li>Exit menu level</li> </ul>
--	--

**5.3.2.5 [PRINT] menu selection**

Scale parameters can be printed in this menu.

Factory settings are marked with "\*"

<ul style="list-style-type: none"> <li>— PRINT</li> <li>— STABLE</li> <li>— OFF</li> <li>— ON</li> <li>— A.PRINT</li> <li>— OFF</li> <li>— ON.STAB</li> </ul>	<ul style="list-style-type: none"> <li>Print criteria</li> <li>Values are printed immediately</li> <li>Values are only printed if they are stable*</li> <li>Automatic printout</li> <li>deactivated*</li> <li>printing on stability</li> </ul>
---	--

<ul style="list-style-type: none"> <li>— INTER           <ul style="list-style-type: none"> <li>— 1...3600</li> </ul> </li> <li>— CONT</li> <li>— ACCEPT</li> <li>— CONTNT           <ul style="list-style-type: none"> <li>— RESULT               <ul style="list-style-type: none"> <li>— OFF</li> <li>— ON</li> </ul> </li> <li>— GROSS               <ul style="list-style-type: none"> <li>— OFF</li> <li>— ON</li> </ul> </li> <li>— NET               <ul style="list-style-type: none"> <li>— OFF</li> <li>— ON</li> </ul> </li> <li>— TARE               <ul style="list-style-type: none"> <li>— OFF</li> <li>— ON</li> </ul> </li> <li>— HEADER               <ul style="list-style-type: none"> <li>— OFF</li> <li>— ON</li> </ul> </li> <li>— FOOTER               <ul style="list-style-type: none"> <li>— OFF</li> <li>— ON</li> </ul> </li> <li>— MODE               <ul style="list-style-type: none"> <li>— OFF</li> <li>— ON</li> </ul> </li> <li>— INFO               <ul style="list-style-type: none"> <li>— OFF</li> <li>— ON</li> </ul> </li> <li>— TOTAL               <ul style="list-style-type: none"> <li>— OFF</li> <li>— RESULT</li> <li>— ALL</li> </ul> </li> </ul> </li> <li>— LI.SET           <ul style="list-style-type: none"> <li>— FORMAT               <ul style="list-style-type: none"> <li>— MULTI</li> <li>— SINGLE</li> </ul> </li> <li>— FEED               <ul style="list-style-type: none"> <li>— LINE</li> <li>— 4LF</li> <li>— FORM</li> </ul> </li> </ul> </li> <li>— RESET           <ul style="list-style-type: none"> <li>— NO</li> <li>— YES</li> </ul> </li> <li>— END</li> </ul>	<p>Printing in the specified interval 1 ... 3,600 seconds</p> <p>Print continuously</p> <p>Printing on stability and within the tolerance limits</p> <p>Content of a printout</p> <p>Displayed value deactivated activated*</p> <p>Gross value deactivated* activated</p> <p>Net value deactivated* activated</p> <p>Tare deactivated* activated</p> <p>Header deactivated* activated</p> <p>Info on the footer deactivated* activated</p> <p>Info on the application mode deactivated* activated</p> <p>No effect in this device deactivated* activated</p> <p>Totalizing memory/statistics data deactivated*</p> <p>Totalizing memory is printed</p> <p>Totalizing memory/statistics data are printed</p> <p>Totalizing memory</p> <p>Format sent to printer and PC Multi-line (single-column) printout* Single-line printout</p> <p>Setting of the paper feed One-line feed Four-line feed* Page feed after printing</p> <p>Factory settings not reset* activated</p> <p>Exit menu level</p>
---	---

### 5.3.2.6 [PRN.COM] menu selection

The parameters for the print communication can be specified in this menu.  
Factory settings are marked with "\*"

<b>PRN.COM</b>	
— <b>BAUD</b>	Baud rate
2400	2,400
4800	4,800
9600	9,600*
19200	19,200
38400	38,400
57600	57,600
115200	115,200
— <b>PARITY</b>	Parity
7 EVEN	7 data bits, even parity
7 Odd	7 data bits, odd parity
7 NONE	7 data bits, no parity
8 NONE	8 data bits, no parity*
— <b>STOP</b>	Stop bit
1	1*
2	2
— <b>RESET</b>	Factory settings
NO	not reset*
YES	activated
— <b>END</b>	Exit menu level

### 5.3.2.7 [PC.OUT] menu selection

The parameters for the PC output can be specified in this menu.

Factory settings are marked with "\*"

<b>PC.OUT</b>	
— <b>MODE</b>	PC output mode
OFF	deactivated*
MAN.OUT	Manual output
MAN.STA	Manual output, if data are stable
INT.OUT	Interval output
AUT.OUT	Automatic output
AUT.STA	Automatic output, if data are stable
— <b>INTERV</b>	Specify output interval (if INT.OUT is selected)
1 CYC	Every display cycle
2 CYC	After 2 display cycles
5 CYC	After 5 display cycles*
10 CYC	After 10 display cycles
20 CYC	After 20 display cycles
50 CYC	After 50 display cycles
100 CYC	After 100 display cycles
— <b>RESET</b>	Factory settings
NO	not reset*
YES	activated
— <b>END</b>	Exit menu level

### 5.3.2.8 [PC.COM] menu selection

The parameters for the PC communication can be specified in this menu.

Factory settings are marked with "\*"

<b>PC.COM</b>	
— <b>BAUD</b>	Baud rate

— 4800	4,800
— 9600	9,600*
— 19200	19,200
— 38400	38,400
— 57600	57,600
— 115200	115,200
— <b>PARITY</b>	Parity
— 7 EVEN	7 data bits, even parity
— 7 Odd	7 data bits, odd parity
— 7 NONE	7 data bits, no parity
— 8 NONE	8 data bits, no parity*
— 7 MARK	7 data bits, mark parity
— 7 SPACE	7 data bits, space parity
— <b>STOP</b>	Stop bit
— 1	1*
— 2	2
— <b>HAND.SH</b>	Handshake
— NONE	No handshake*
— XON.XOF	No function
— <b>RESET</b>	Factory settings
— NO	not reset*
— YES	activated
— <b>END</b>	Exit menu level

### 5.3.2.9 [CAL.ADJ] menu selection

The scale can be calibrated and adjusted in this menu (see Chapter [5.4](#)).

<b>CAL.ADJ</b>	
— <b>CAL</b>	Initiates a two-point calibration (zero and max. load)
— <b>LIN</b>	Initiates a linearization (zero, half weighing range and max. load)
— <b>GEO</b>	The adjustment of the calibration based on the current location is carried out using the geographic adjustment factor (GEO). (Settings from 0 ... 31, default value = 12)
— <b>END</b>	Exit menu level

### 5.3.2.10 [INFO] menu selection

<b>INFO</b>	
— <b>TYPE</b>	Display model name
— <b>SER.NUM</b>	Display serial number

### 5.3.2.11 [SECURE] menu selection

The safety setting (lock) for menu access can be defined via this menu in order to prevent unauthorized interventions.

Factory settings are marked with "\*"

<b>SECURE</b>	
— <b>S.APPLI</b>	Application menu
— OFF	Unlock*
— ON	Locked
— <b>S.UNIT</b>	Unit menu

—	— OFF	Unlock*
	— ON	Locked
—	<b>S.OP.FUN</b>	Operating functions menu
	— OFF	Unlock*
	— ON	Locked
—	<b>S.METRO</b>	Metrology menu
	— OFF	Unlock*
	— ON	Locked
—	<b>S.PRINT</b>	Printer output menu
	— OFF	Unlock*
	— ON	Locked
—	<b>S.PR.COM</b>	Printer communication menu
	— OFF	Unlock*
	— ON	Locked
—	<b>S.PC.OUT</b>	PC output menu
	— OFF	Unlock*
	— ON	Locked
—	<b>S.PC.COM</b>	PC communication menu
	— OFF	Unlock*
	— ON	Locked
—	<b>S.CAL.AD</b>	Calibration/adjustment menu
	— OFF	Unlock*
	— ON	Locked
—	<b>RESET</b>	Restore factory setting of the current menu
	— OFF	Unlock*
	— ON	Locked
—	<b>END</b>	Exit menu level

## 5.4 Calibration and adjustment

The scale can be calibrated and adjusted in this menu.

### Initial calibration

If the scale is being put into operation for the first time, calibration is recommended in order to ensure precise weighing results. Before the calibration, ensure that the appropriate calibration weights are available.

Adjust the GEO setting according to the location (see Table 5.4.4).

### CAL.ADJ

—	<b>CAL</b>	Initiates a two-point calibration (zero and max. load)
—	<b>LIN</b>	Initiates a linearization (zero, half weighing range and max. load)
—	<b>GEO</b>	The adjustment of the calibration based on the current location is carried out using the geographic adjustment factor (GEO). (Settings from 0 ... 31, default value = 12)
—	<b>END</b>	Exit menu level

### 5.4.1 [CAL] calibration

Call up the menu mode:



1. Press and hold  until [M.E.N.U] is displayed.





Release the key.

- ▷ The first menu item [APPLIC] (application) is displayed.

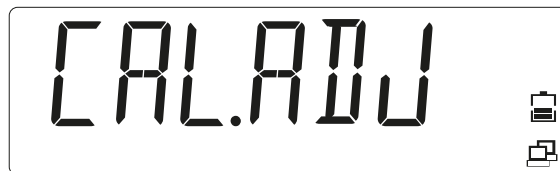

2. Press the  key in order to go to the next menu item, or press the  key to go to the previous menu item.
3. Change the menu item until [CAL.ADJ] is displayed.



4. Press the  (Yes) key to go to the sub-menu item.
  - ▷ The sub-menu item [CAL] (calibration) is displayed.



5. Press the  (Yes) key to start a calibration.
  - ▷ [0 kg] is shown. [0] flashes.



6. Empty the load plate.

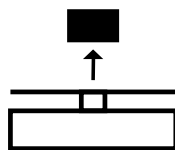

7. Press the  (Yes) key to start the zero point adjustment.
  - ▷ [--C--] is displayed while the zero value is being saved.

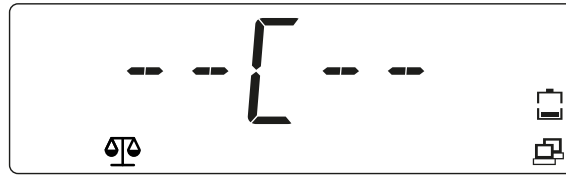

The value of the calibration weight is shown in the display; all digits ([001500.0]) flash (in this example 1,500 kg)

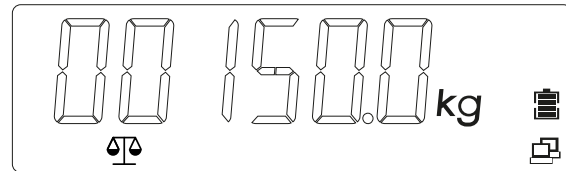

8. To change the value of the calibration weight, press the  (No) key and change the value.



▷ The first digit flashes: [0015.000 kg].



9. Press the  (Yes) key in order to confirm the value and to go to the next digit.

▷ The second digit flashes: [0015.000 kg].



10. Press the  key to increase the value, or the  key to decrease the value.

11. Repeat until all digits are correct.

▷ The value of the calibration weight is displayed using flashing digits in the display: [00100.0] (in this example 100.0 kg)

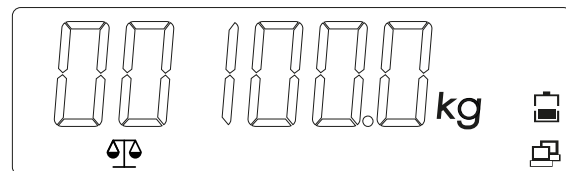

12. If the value of the calibration weight is correct, place the specified weight on the load plate.

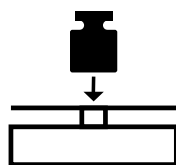

13. Press the  (Yes) key to adopt the second calibration point.



- ▷ [--C--] is displayed while the calibration weight is being saved.

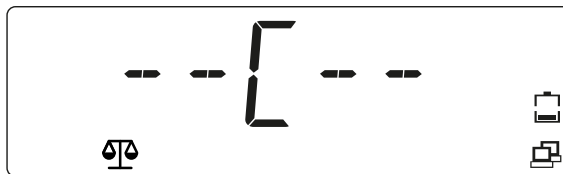

In the event of an error during the calibration process, [CALE] (calibration error) is displayed and the process is canceled.



14. Remove the weight.
  - ▷ The scale is ready for operation.



#### 5.4.2 [LIN] linearization

Call up the menu mode:

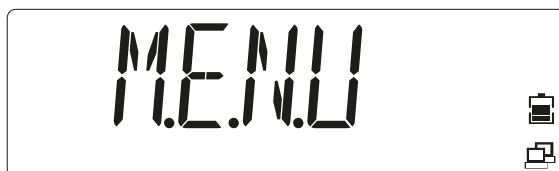

1. Press and hold  until [M.E.N.U] is displayed.





Release the key.

- ▷ The first menu item [APPLIC] (application) is shown in the display.

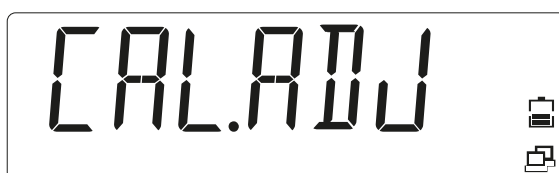

2. Press the  key in order to access the next menu item, or press the  key to access the previous menu item.
3. Repeat until [CAL.ADJ] is shown in the display.



4. Press the  (Yes) key to access the sub-menu item.
5. Select until [LIN] is shown in the display.



6. Press the  (Yes) key to start the linearization.
  - ▷ [0 kg] is shown in the display. [0] flashes.



7. Empty the load plate.

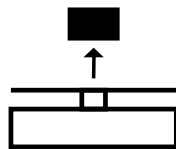

8. Press the  (Yes) key to confirm that no load has been applied.
  - ▷ [--C--] is displayed while the zero value is being saved.

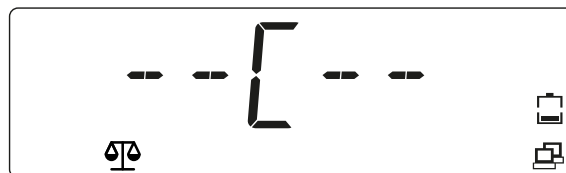

In the display, the value of the 1<sup>st</sup> linearization weight (50% of the capacity of the scale) is displayed with flashing digits [00075.0] (in this example 75 kg). This value cannot be changed.

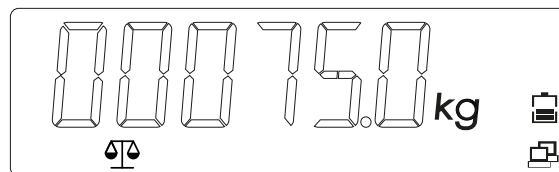

9. Place the 1<sup>st</sup> linearization weight on the load plate.

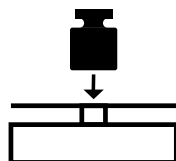

10. Press the  (Yes) key to start the linearization at 50% of the capacity of the scale.
  - ▷ [--C--] is displayed while the value is being saved.

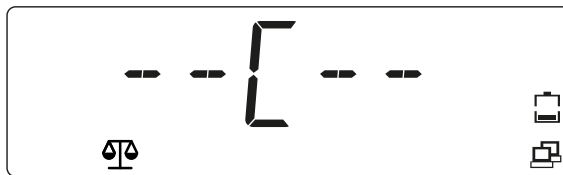

In the display, the value of the 2<sup>nd</sup> linearization weight at 100% of the capacity of the scale is displayed with flashing digits [00150.0] (in this example 150 kg).

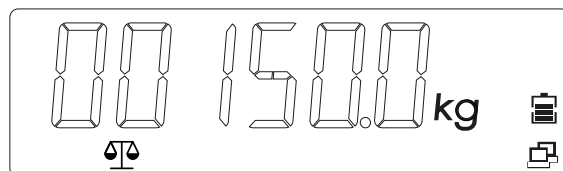

11. Place the 2<sup>st</sup> linearization weight on the load plate.

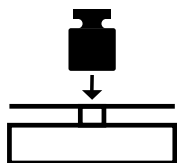

12. Press the  (Yes) key to start the linearization at . 100% of the capacity of the scale.

▷ [--C--] is displayed while the value is being saved.

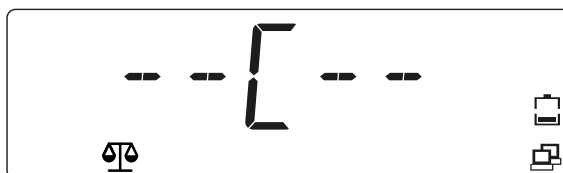

In the display, the value of the linearization weight at 100% of the capacity of the scale is displayed [00150.0] (in this example 150 kg).



If an error occurs during the linearization, [CALE] (calibration error) is displayed and the process is canceled.



13. Remove the weight.  
▷ The scale is ready for operation.

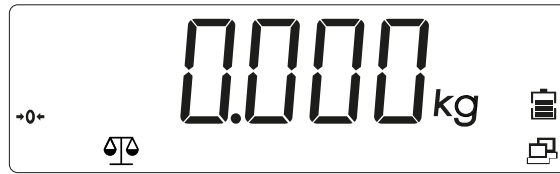

### 5.4.3 [GEO] geographic data (calibration location)

The adjustment of the calibration based on the current location is carried out using the geographic adjustment factor [GEO]. (Settings from 0 ... 31 are available.) The table under [5.4.4](#) contains the GEO values for a wide range of latitudes.

Call up the menu mode:

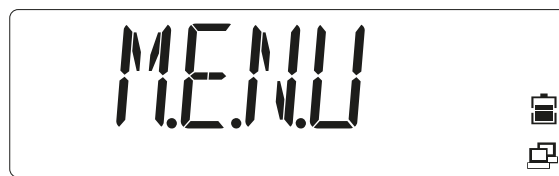

1. Press and hold  until [M.E.N.U] (menu) is displayed.





Release the key.

- ▷ The first menu item [APPLIC] (application) is shown in the display.



2. Press the  key in order to access the next menu item, or press the  key to access the previous menu item.
3. Repeat until [CAL.ADJ] is shown in the display.





4. Press the  (Yes) key to access the sub-menu item.
5. Press the  key in order to access the next menu item, or press the  key to access the previous menu item.
6. Change the menu item until [GEO] (Geo selection) is displayed.





7. Press the  (Yes) key to start the GEO selection.
  - ▷ The GEO value [12] set by default flashes in the display.



8. If the value needs to be changed, select a value between 0 ... 31 and press the  key to increase the GEO value, or press the  key to decrease the GEO value.
9. Press the  (Yes) key to confirm the GEO value.
  - ▷ The GEO value has been saved when [END] is displayed.



10. Press the  (Yes) key to access the options of the sub-menu.
11. Press the  (No) key to return to the first item in the current menu.
12. Press the  key to exit the settings menu and return to the Weighing application.

#### 5.4.4 GEO code table

Altitude in meters												
0	325	650	975	1,300	1,625	1,950	2,275	2,600	2,925	3,250		
325	650	975	1,300	1,625	1,950	2,275	2,600	2,925	3,250	3,575		
Altitude in feet												
0	1,016	2,130	3,200	4,260	5,330	6,400	7,460	8,530	9,600	10,660		
1,060	2,130	3,200	4,260	5,330	6,400	7,460	8,530	9,600	10,660	11,730		
Latitude		GEO value										
0°00'	5°46'	5	4	4	3	3	2	2	1	1	0	0
5°46'	9°52'	5	5	4	4	3	3	2	2	1	1	0
9°52'	12°44'	6	5	5	4	4	3	3	2	2	1	1
12°44'	15°06'	6	6	5	5	4	4	3	3	2	2	1
15°06'	17°10'	7	6	6	5	5	4	4	3	3	2	2
17°10'	19°02'	7	7	6	6	5	5	4	4	3	3	2
19°02'	20°45'	8	7	7	6	6	5	5	4	4	3	3
20°45'	22°22'	8	8	7	7	6	6	5	5	4	4	3
22°22'	23°54'	9	8	8	7	7	6	6	5	5	4	4
23°54'	25°21'	9	9	8	8	7	7	6	6	5	5	4
25°21'	26°45'	10	9	9	8	8	7	7	6	6	5	5
26°45'	28°06'	10	10	9	9	8	8	7	7	6	6	5
28°06'	29°25'	11	10	10	9	9	8	8	7	7	6	6

		Altitude in meters										
		0	325	650	975	1,300	1,625	1,950	2,275	2,600	2,925	3,250
		325	650	975	1,300	1,625	1,950	2,275	2,600	2,925	3,250	3,575
		Altitude in feet										
		0	1,016	2,130	3,200	4,260	5,330	6,400	7,460	8,530	9,600	10,660
		1,060	2,130	3,200	4,260	5,330	6,400	7,460	8,530	9,600	10,660	11,730
Latitude		GEO value										
29°25'	30°41'	11	11	10	10	9	9	8	8	7	7	6
30°41'	31°56'	12	11	11	10	10	9	9	8	8	7	7
31°56'	33°09'	12	12	11	11	10	10	9	9	8	8	7
33°09'	34°21'	13	12	12	11	11	10	10	9	9	8	8
34°21'	35°31'	13	13	12	12	11	11	10	10	9	9	8
35°31'	36°41'	14	13	13	12	12	11	11	10	10	9	9
36°41'	37°50'	14	14	13	13	12	12	11	11	10	10	9
37°50'	38°58'	15	14	14	13	13	12	12	11	11	10	10
38°58'	40°05'	15	15	14	14	13	13	12	12	11	11	10
40°05'	41°12'	16	15	15	14	14	13	13	12	12	11	11
41°12'	42°19'	16	16	15	15	14	14	13	13	12	12	11
42°19'	43°26'	17	16	16	15	15	14	14	13	13	12	12
43°26'	44°32'	17	17	16	16	15	15	14	14	13	13	12
44°32'	45°38'	18	17	17	16	16	15	15	14	14	13	13
45°38'	46°45'	18	18	17	17	16	16	15	15	14	14	13
46°45'	47°51'	19	18	18	17	17	16	16	15	15	14	14
47°51'	48°58'	19	19	18	18	17	17	16	16	15	15	14
48°58'	50°16'	20	19	19	18	18	17	17	16	16	15	15
50°16'	51°13'	20	20	19	19	18	18	17	17	16	16	15
51°13'	52°22'	21	20	20	19	19	18	18	17	17	16	16
52°22'	53°31'	21	21	20	20	19	19	18	18	17	17	16
53°31'	54°41'	22	21	21	20	20	19	19	18	18	17	17
54°41'	55°52'	22	22	21	21	20	20	19	19	18	18	17
55°52'	57°04'	23	22	22	21	21	20	20	19	19	18	18
57°04'	58°17'	23	23	22	22	21	21	20	20	19	19	18
58°17'	59°32'	24	23	23	22	22	21	21	20	20	19	19
58°17'	59°32'	24	23	23	22	22	21	21	20	20	19	19
60°49'	62°90'	25	24	24	23	23	22	22	21	21	20	20
62°90'	63°30'	25	25	24	24	23	23	22	22	21	21	20

Altitude in meters												
<b>0</b>	<b>325</b>	<b>650</b>	<b>975</b>	<b>1,300</b>	<b>1,625</b>	<b>1,950</b>	<b>2,275</b>	<b>2,600</b>	<b>2,925</b>	<b>3,250</b>	<b>3,575</b>	
<b>325</b>	<b>650</b>	<b>975</b>	<b>1,300</b>	<b>1,625</b>	<b>1,950</b>	<b>2,275</b>	<b>2,600</b>	<b>2,925</b>	<b>3,250</b>	<b>3,575</b>		
Altitude in feet												
<b>0</b>	<b>1,016</b>	<b>2,130</b>	<b>3,200</b>	<b>4,260</b>	<b>5,330</b>	<b>6,400</b>	<b>7,460</b>	<b>8,530</b>	<b>9,600</b>	<b>10,660</b>	<b>11,730</b>	
<b>1,060</b>	<b>2,130</b>	<b>3,200</b>	<b>4,260</b>	<b>5,330</b>	<b>6,400</b>	<b>7,460</b>	<b>8,530</b>	<b>9,600</b>	<b>10,660</b>	<b>11,730</b>		
Latitude		GEO value										
<b>63°30'</b>	<b>64°55'</b>	26	25	25	24	24	23	23	22	22	21	21
<b>64°55'</b>	<b>66°24'</b>	26	26	25	25	24	24	23	23	22	22	21
<b>66°24'</b>	<b>67°57'</b>	27	26	26	25	25	24	24	23	23	22	22
<b>67°57'</b>	<b>69°35'</b>	27	27	26	26	25	25	24	24	23	23	22
<b>69°35'</b>	<b>71°21'</b>	28	27	27	26	26	25	25	24	24	23	23
<b>71°21'</b>	<b>73°16'</b>	28	28	27	27	26	26	25	25	24	24	23
<b>73°16'</b>	<b>75°24'</b>	29	28	28	27	27	26	26	25	25	24	24
<b>75°24'</b>	<b>77°55'</b>	29	29	28	28	27	27	26	26	25	25	24
<b>77°55'</b>	<b>80°56'</b>	30	29	29	28	28	27	27	26	26	25	25
<b>80°56'</b>	<b>85°45'</b>	30	30	29	29	28	28	27	27	26	26	25
<b>85°45'</b>	<b>90°00'</b>	31	30	30	29	29	28	28	27	27	26	26

## 5.5 SBI interface

A computer connected via the PC interface (SBI communication) can send control commands to the analysis device in order to control the scale or application functions.

All commands have a shared frame format (data input format). They start with the characters ESC and end with the command end EOC (end of command). The end of command may also be a combination of CR and LF. The scale ignores all entries after EOC and before ESC.

### Reading the displayed value:

ESC	P	EOC													
Response (16 bytes):															
V	W	W	W	W	W	W	W	W	W	W	E	E	E	CR	LF
V	Algebraic sign		Possible characters: "+", "-", ""												
W	Weight value		Possible characters: "0"..."9", ".", "", ""												
E	Unit		Possible characters: "a"..."z", "A"..."Z", ""												
CR	Carriage return		ASCII 0x0D												

---

LF	Line feed	ASCII 0x0A
----	-----------	------------

---

This format is also used for automatically generated telegrams, which are released according to the menu settings: [INT.OUT], [AUT.OUT], [AUT.STA] (see above).

#### Zeroing the scale:

---

ESC	Z	EOC
-----	---	-----

---

Response: see special response telegrams

#### Taring the scale:

---

ESC	T	EOC
-----	---	-----

---

Response: see special response telegrams

#### Special response telegrams:

There are some special responses, which are used as standard responses. Example: Error or confirmation. Special response telegrams are always 5 bytes.

#### OK (confirmed)

---

1	2	3	4	5
O	K	!	CR	LF

---

The scale confirms error-free performance of the command.

#### ERROR (error)

---

1	2	3	4	5
E	R	R	CR	LF

---

The scale reports an error when performing the command.

#### LOCKED (locked)

---

1	2	3	4	5
L	O	C	CR	LF

---

The command cannot be performed because a parameter is currently blocked.



## 6 Maintenance/repairs/cleaning

### 6.1 Repairs

Disconnect a defective device from the mains immediately.

Defective or damaged cables or screw connections must be replaced as a complete unit.

#### **WARNING**

**Improper repairs can pose considerable risks to the user.**

- ▶ Only have repairs carried out by Minebea Intec qualified dealers using original spare parts.

### 6.2 Cleaning

#### 6.2.1 Instructions for cleaning

The device must be cleaned of contaminants on a regular basis.

Before cleaning, maintenance, or repairs, disconnect the device from the supply voltage.

If the scale is in a dry environment, wipe the weighing platform with a damp cloth.

Household cleaning agents can be used. Please check the information provided by the manufacturer.

In the case of devices with an IP43 protection grade, no liquid must get into the scale.

The device must not be cleaned using a high-pressure or steam cleaner. Observe the IP protection grade.

If the device is cleaned with water that is too hot or too cold due to temperature differences, condensation may form in the device. Condensation may cause malfunctions in the device.

#### 6.2.2 Cleaning agents

#### **NOTICE**

**Some cleaning agents may not be compatible with the device material.**

- ▶ Only use disinfectants and cleaning agents in line with the manufacturer's instructions.
- ▶ Do not use cleaning agents that are very acidic, very alkaline, or that contain a high level of chlorine. Avoid substances with a high or low pH value as otherwise there is an increased risk of corrosion.
- ▶ Do not use any abrasive sponges containing iron, steel brushes, or cleaning sponges made of steel wool.
- ▶ Always test cleaning agents and materials in non-critical areas first before using them.

## 7 Waste disposal policy

If the packaging is no longer required, please take it to your local waste disposal facility and/or a reputable disposal company or collection point. The packaging largely consists of environmentally friendly materials, which are suitable for recycling.

It is not permitted—even for small businesses—to dispose of this product with the regular household waste or at collection points run by local public waste disposal companies.

EU legislation requires its Member States to collect electrical and electronic equipment and dispose of it separately from other unsorted municipal waste so that it can then be recycled.

Before disposing of or scrapping the product, any batteries should be removed and taken to a suitable collection point.

Please see our T&Cs for further information.

We reserve the right not to accept products that have been contaminated with hazardous substances (ABC contamination) for repair.

## 8 Error correction

The table lists frequent problems, as well as possible causes and corrective measures. If the problem persists, inform Minebea Intec or an authorized dealer.

Symptom	Possible cause	Corrective measure
Switching on not possible	Scale is not supplied with power	Check connections and voltage
Poor accuracy	Incorrect calibration Unstable environment	Perform a calibration Put scale in a suitable location
Application cannot be called up	Application has not been activated	Activate the application in the menu
Unit cannot be called up	Unit has not been activated	Activate the unit in the menu
Battery icon is flashing	Low battery level	Connect scale to the mains and charge battery
[Err 8.1]	Error during switching on	Read weight exceeds start-up/zeroing limit
[Err 8.2]	Error during switching on	Read weight falls below start-up/zeroing limit
[Err 8.3]	Overload range error	Read weight exceeds overload limit
[Err 8.4]	Underload range error	Read weight falls below overload limit
[Err 8.5]	Tare outside of the tare range	Adjust tare value accordingly
[Err 8.6]	Display capacity fallen short of	Weight > 6 characters
[Err 9.5]	Incorrect calibration data	Repeat calibration
	Busy	Display during tare setting, zero point setting, printing
[--NO--]	Action not permitted	Function cannot be performed
[CAL E]	Calibration error Unstable environment Incorrect calibration weight	Repeat calibration Put scale in a suitable location Use correct calibration weight
[REF.ERR]	Invalid reference weight	The weight on the load plate is too high or too low in order to define a valid reference weight. Reduce or increase reference weight
Battery cannot be fully charged	Battery is defective	Have battery replaced by authorized Minebea Intec service dealer.

## 8.1 Service information

Contact the authorized service partners if a problem cannot be rectified with the aid of the troubleshooting information or is not described there. Our website <http://www.puroscales.com> provides information about your closest service partner.

## 9 Technical data

### 9.1 Specification

<b>Model number</b>	<b>EF - ..</b>	<b>P1</b>	<b>P3</b>	<b>P6</b>	<b>P15</b>	<b>P30</b>
Max load (g)		1,500	3,000	6,000	15,000	30,000
Readability d (g)	- 30 d	0.05	0.1	0.2	0.5	1
Max. resolution		30,000	30,000	30,000	30,000	30,000
Readability d (g)	- 6 d	0.2	0.5	1	2	5
Max. resolution		7,500	6,000	6,000	7,500	6,000
Applications	Weighing, Automatic Tare, Totalizing, Automatic Printing					
Weight units	kg, g, lb, oz, lb:oz					
Version/materials	Housing made of ABS plastic, weighing platform made of stainless steel 304					
Protection grade	IP43					
Display	LCD display with white background lighting on front and rear, digit height 1.1 inches/28 mm					
Indicator displays	3 LEDs (yellow, green, red), function can be configured, acoustic alarm signal					
Keypad	5 mechanical keys					
Zero range	2 or 10% of the max. load of the scale					
Tare range	Max. load via subtraction					
Stabilization time	1 second					
Automatic zero point correction	Off, increments of 0.5, 1, or 3					
Safe overload range	150% of the max. load of the scale					
Leveling aids	Externally visible level indicator and adjustable, non-slip leveling feet					
Electrical supply	U <sub>DC</sub> = 5 V, 2 A, power supply or portable rechargeable lithium battery					
Battery operation time	Up to 210 hours operation time (with standard battery) between the charging processes, 12 hours charge time					
Calibration	External, with freely selectable calibration weights					
Interface	-LT -LF	USB-C, printer port, RS-232 installed				
Interface	-ST -SF	USB-C, printer port installed				
Operating temperature (°C)	-10 ... +40					
Storage temperature (°C)	-10 ... +50					
Product dimensions in mm (W x D x H)	-LT	310 x 302 x 115 mm				

<b>Model number</b>	<b>EF - ..</b>	<b>P1</b>	<b>P3</b>	<b>P6</b>	<b>P15</b>	<b>P30</b>
Platform size (W x L)		280 x 180				
Shipping dimensions in mm (W x D x H)		365 x 365 x 210				
Net weight (kg)		2.9				
Shipping weight (kg)		4.7				
Product dimensions in mm (W x D x H)	- LF	310 x 302 x 85				
Platform size in mm (W x L)		280 x 180				
Shipping dimensions in mm (W x D x H)		365 x 365 x 210				
Net weight (kg)		2.7				
Shipping weight (kg)		4.5				
Product dimensions in mm (W x D x H)	- ST	246 x 302 x 129				
Platform size in mm (W x L)		218 x 180				
Shipping dimensions in mm (W x D x H)		365 x 365 x 210				
Net weight (kg)		2.8				
Shipping weight (kg)		3.2				
Product dimensions in mm (W x D x H)	- SF	246 x 302 x 90				
Platform size in mm (W x L)		218 x 180				
Shipping dimensions in mm (W x D x H)		365 x 365 x 210				
Net weight (kg)		2.6				
Shipping weight (kg)		3				
Accessories		Data printer, USB-C cable (cannot be used for PC communication), printer connection cable, weighing hooks, lithium battery				

## 9.2 Accessories

<b>Option</b>	<b>Order no.</b>
Data printer	YP-DP1
Paper for data printer	YP-P1
USB-C cable (cannot be used for PC communication)	YP-CAC1
Printer cable	YP-CAS1
USB charging device	YP-PS1

---

Option	Order no.
Weighing hooks	YP-H1

---

### 9.3 Dimensions

#### LargeTall (LT)

---

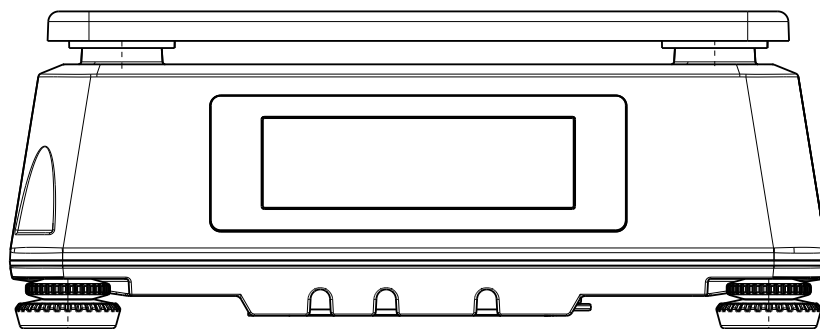
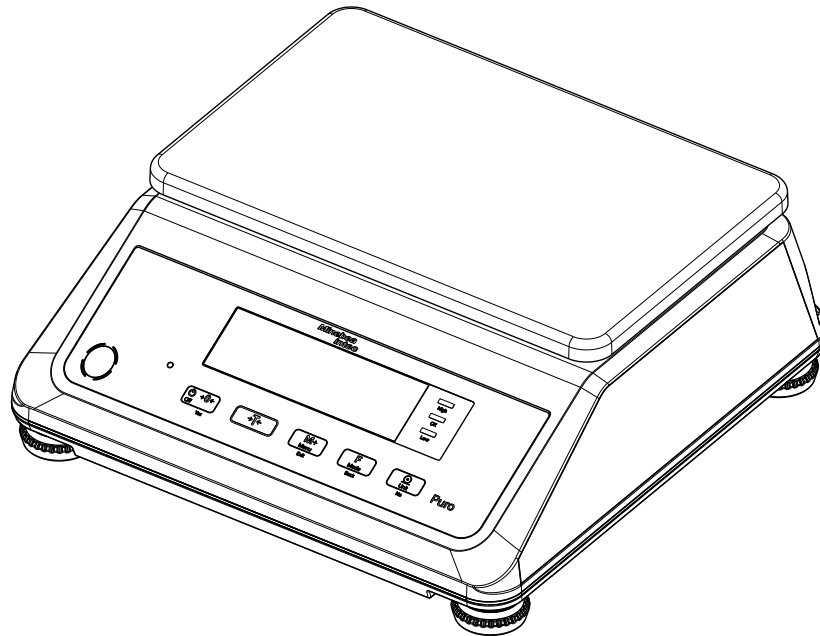

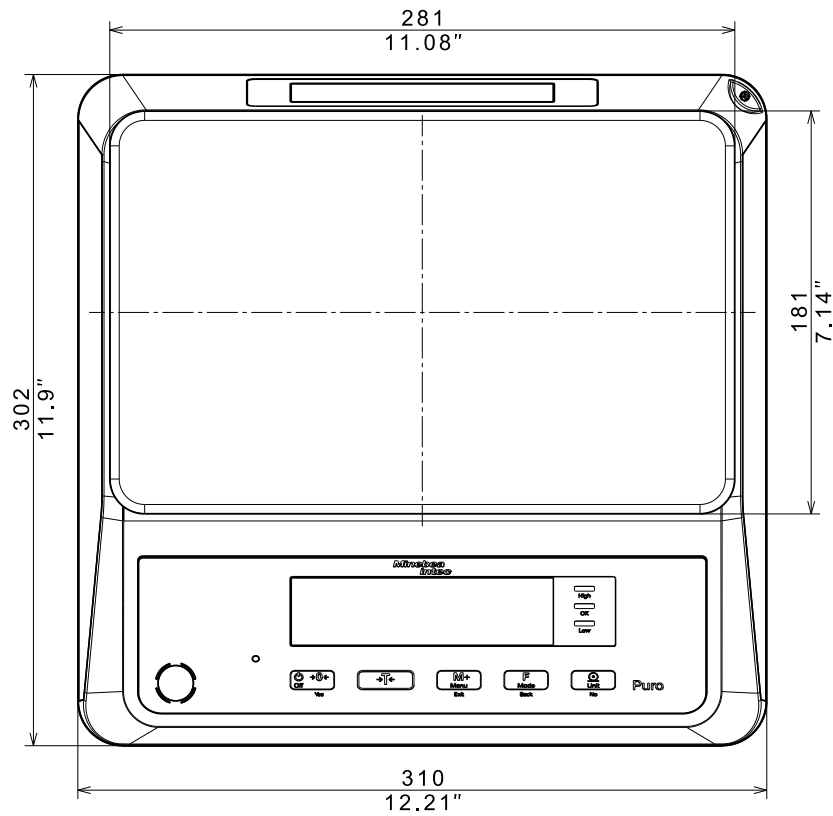

All dimensions in mm / inch

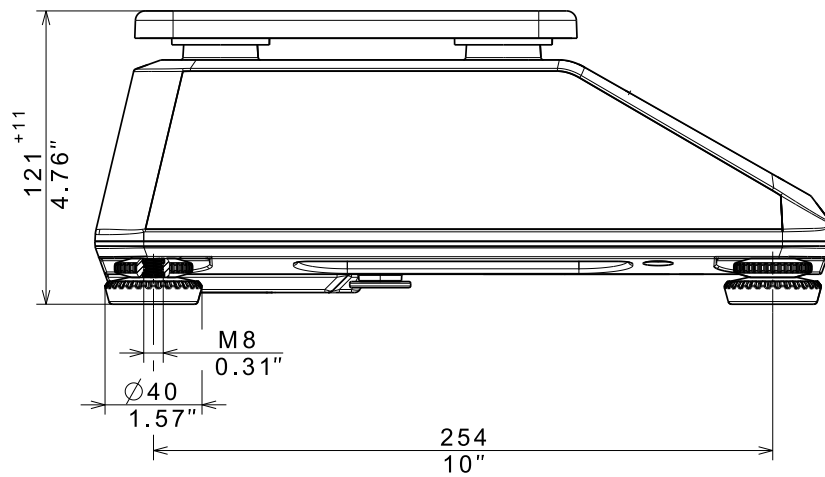

All dimensions in mm / inch



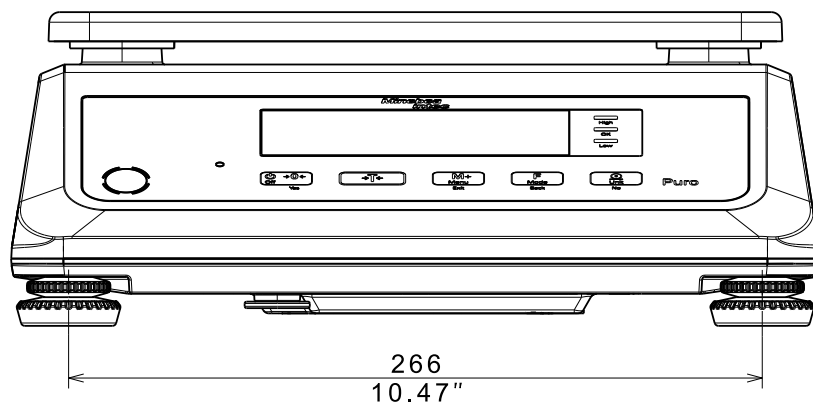

All dimensions in mm / inch

### LargeFlat (LF)

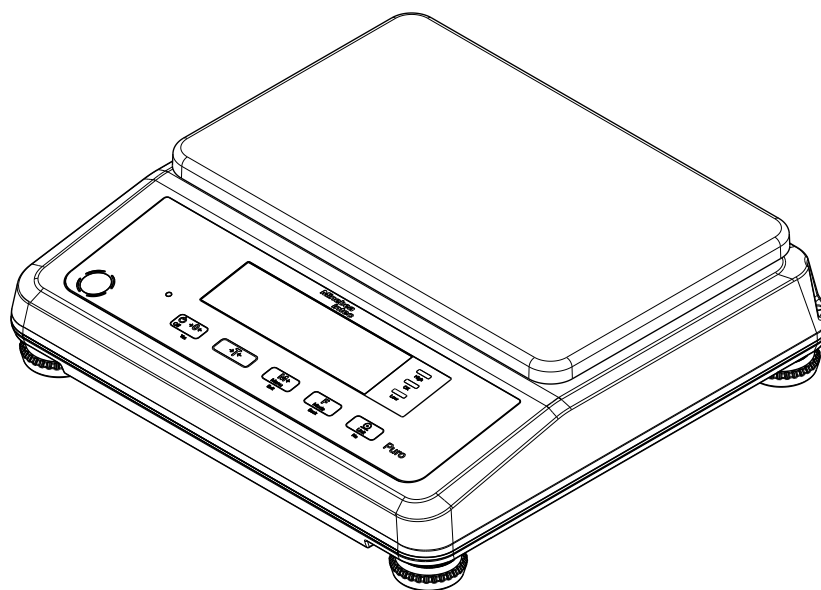

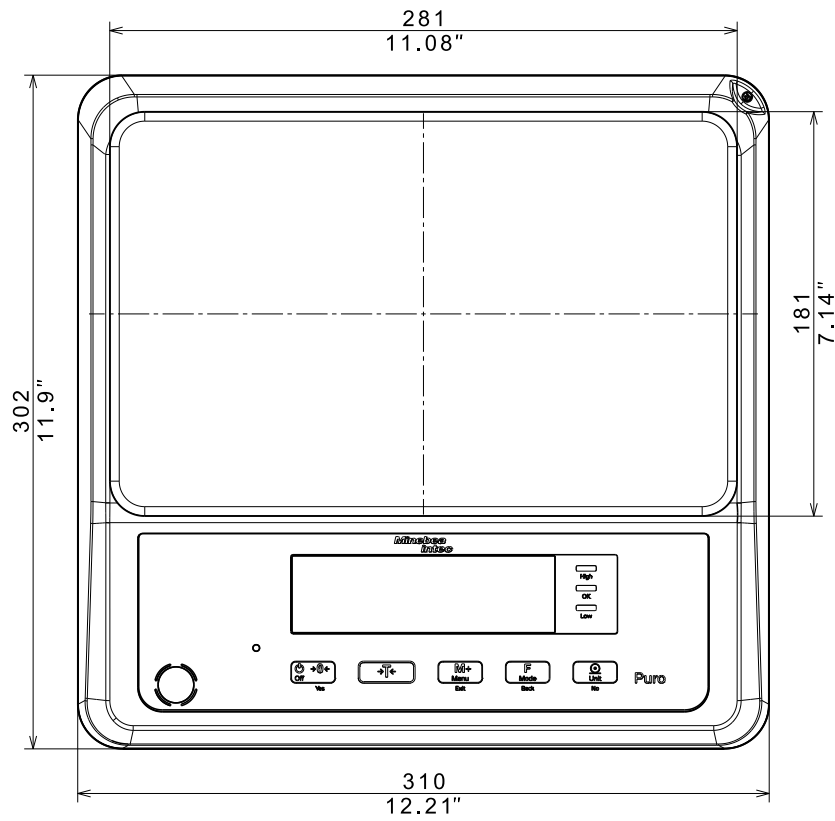

All dimensions in mm / inch

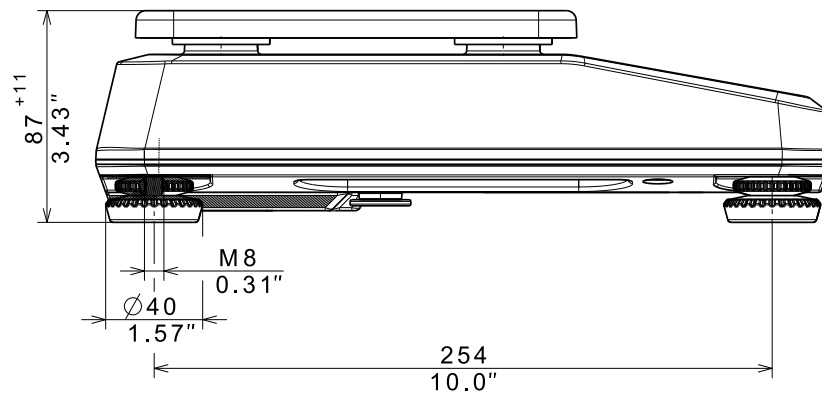

All dimensions in mm / inch

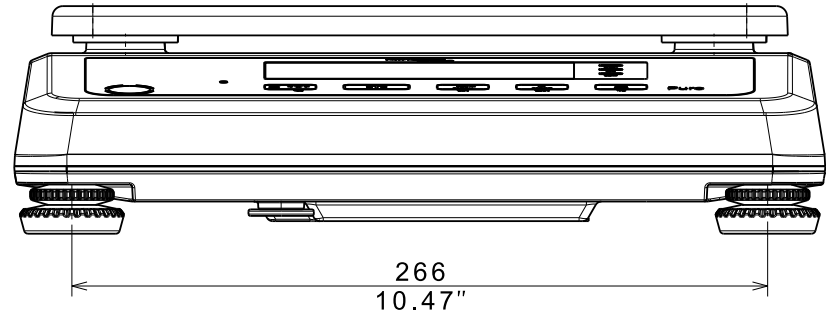

All dimensions in mm / inch

**SmallTall (ST)**

---

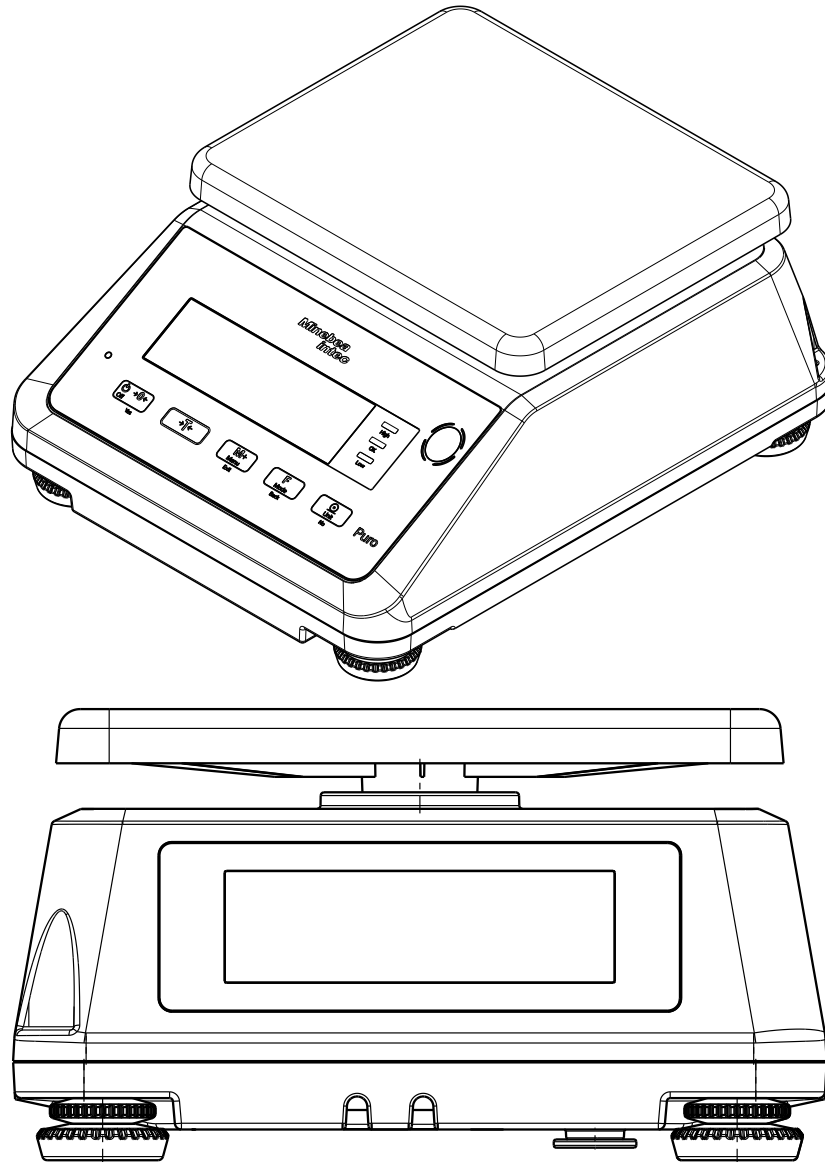

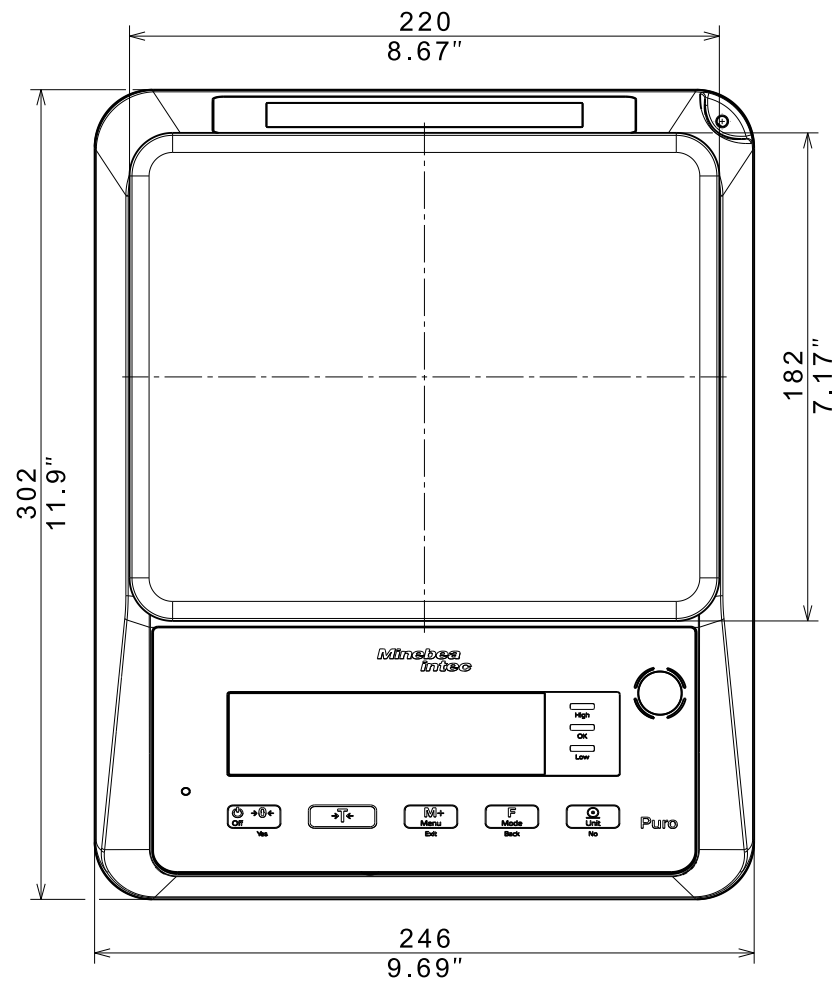

All dimensions in mm / inch

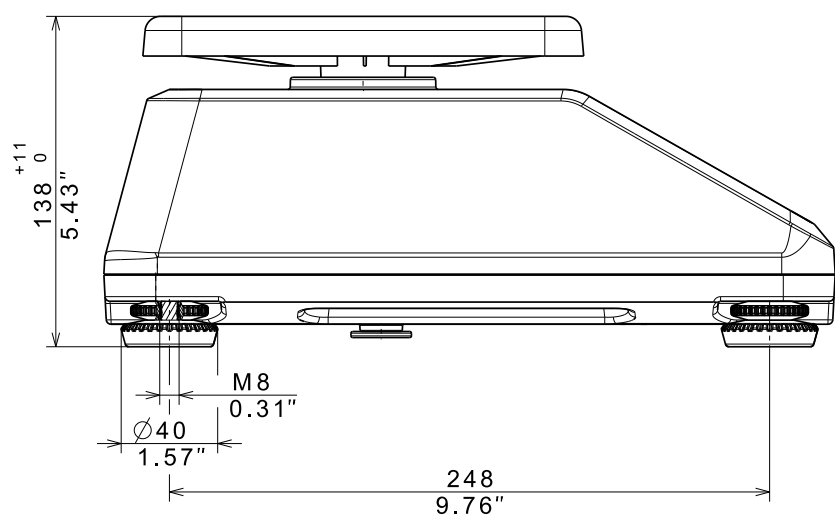

All dimensions in mm / inch

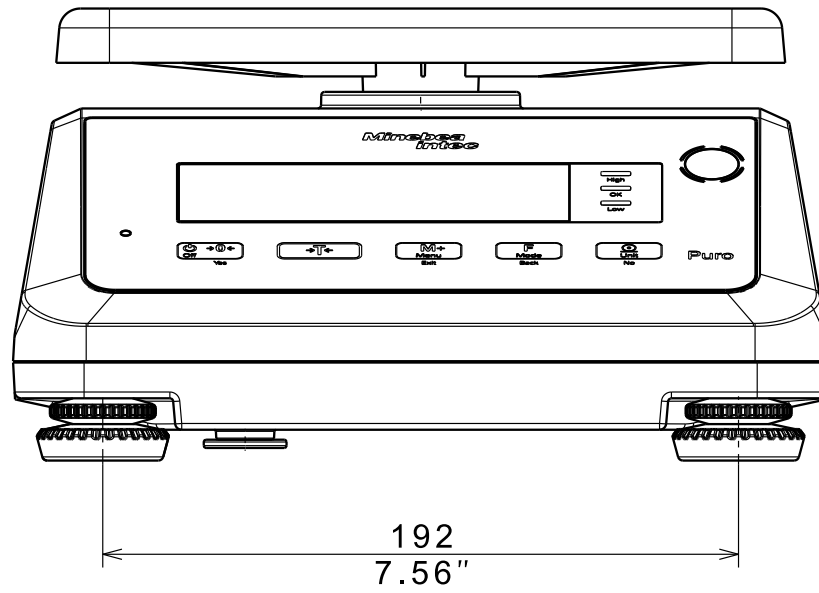

All dimensions in mm / inch

---

### SmallFlat (SF)

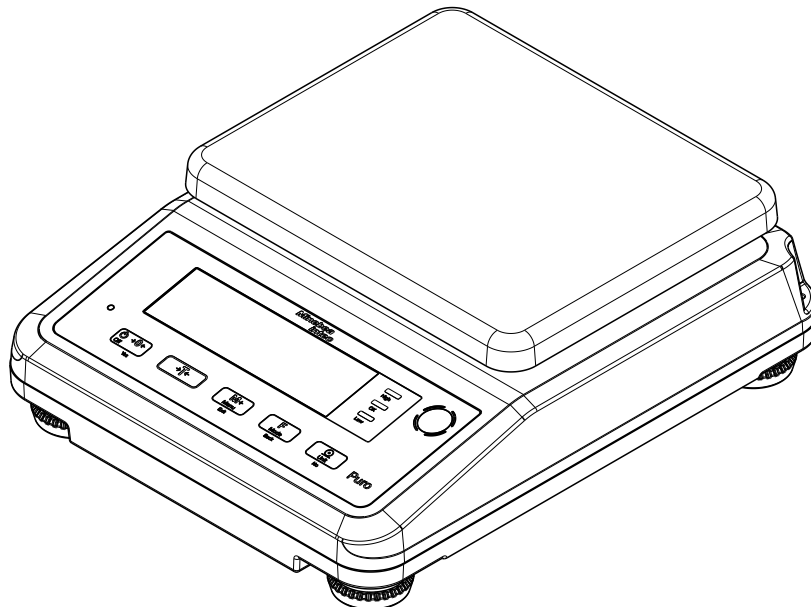

All dimensions in mm / inch

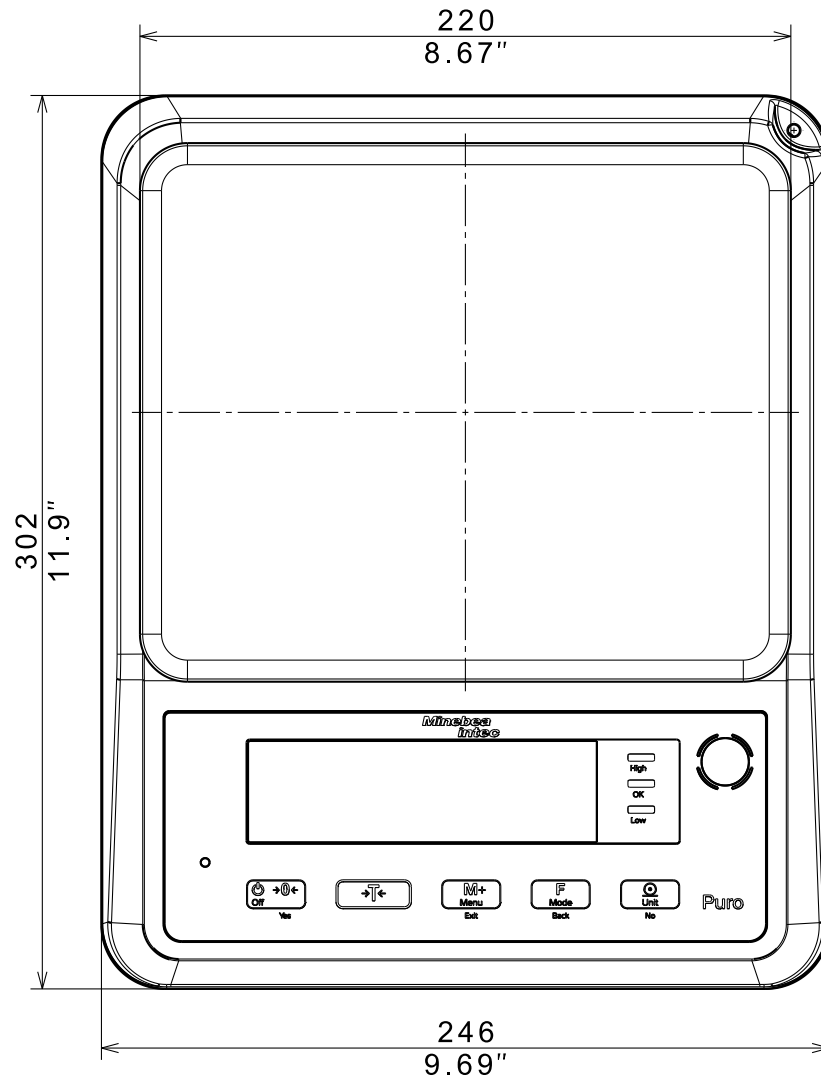

All dimensions in mm / inch

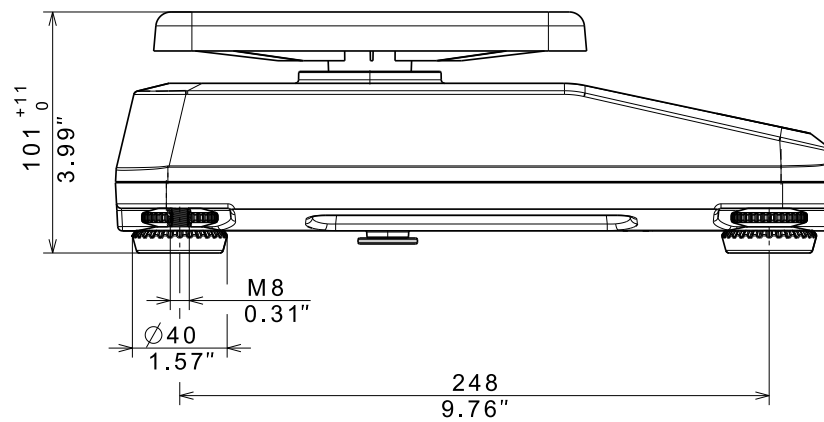

All dimensions in mm / inch

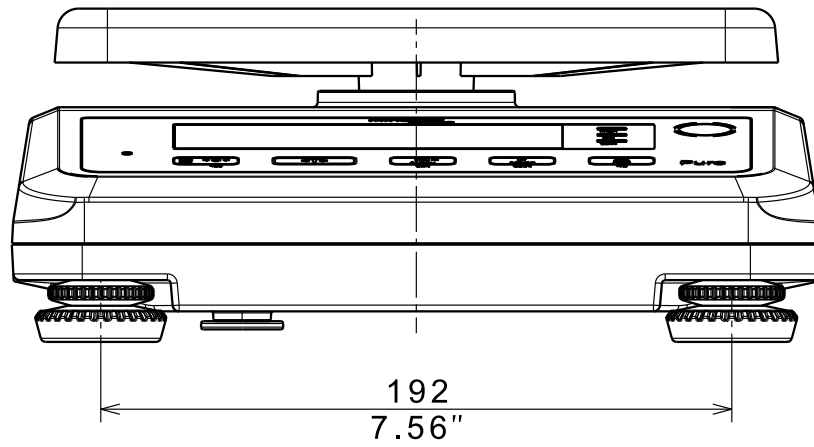

All dimensions in mm / inch



## 10 Appendix

### 10.1 Printouts

Printouts can be created by pressing the  key or using the control command "P". The settings for printouts can be changed in the menu (see Chapter [5.3.2.5](#)).

Example printouts:

#### Printout for the Weighing application

	Description	Note
11.11 kg N	Result line	If Printx → Content → Result = ON
1.23 kg T	Tare value line	If Printx → Content → Tare = ON
11.11 kg N	Net value line	If Printx → Content → Net = ON
12.34 kg G	Gross value line	If Printx → Content → Gross = ON
MODE: WEIGHT	Mode line	If Printx → Content → Application mode = ON
<no line printed>	Information line	If Printx → Content → Info = ON

#### Printout for the Weighing application with Totalizing application

	Description	Note
11.11 kg N	Result line	If Printx → Content → Result = ON
1.23 kg T	Tare value line	If Printx → Content → Tare = ON
11.11 kg N	Net value line	If Printx → Content → Net = ON
12.34 kg G	Gross value line	If Printx → Content → Gross = ON
MODE: WEIGHT	Mode line	If Printx → Content → Application mode = ON
N: 4	Total line	If Printx → Content → Total = All
TOTAL: 50.35 kg	Total line	If Printx → Content → Total = All or Result
MIN: 11.11 kg	Total line	If Printx → Content → Total = All
MAX: 14.85 kg	Total line	If Printx → Content → Total = All

### 10.2 FCC notice

#### Note:

This device has been tested and found to comply with the limits for digital devices of class B as per part 15 of the FCC regulations. These limits were created in order to ensure appropriate protection against interference when operating in residential areas. This device generates, uses, and may emit high-frequency energy and, if it is not installed and used in accordance with the operating instructions, may cause interference with radio communication. However, there is no guarantee that interference will not occur in certain facilities. If this device causes interference with the radio or television reception, which can be determined by switching the device off and then back on again, we recommend one or more of the following measures to eliminate the interference:

- Realignment or repositioning of the reception antenna
- Increasing the distance between the device and the receiver
- Connecting the device and the receiver to separate electric circuits
- Call in the dealer or an experienced radio/television technician

Published by  
Minebea Intec Bovenden GmbH & Co. KG | Leinetal 2 | 37120 Bovenden, Germany  
Phone: +49.551.309.83.0 | Email: [info@minebea-intec.com](mailto:info@minebea-intec.com)  
[www.minebea-intec.com](http://www.minebea-intec.com)

