

**Operating Instructions**

**Floor scale Puro®**



## **Foreword**

### **Must be followed!**

Any information in this document is subject to change without notice and does not represent a commitment on the part of Minebea Intec unless legally prescribed. This product should only be operated/installed by trained and qualified personnel. In correspondence concerning this product, the type, name, and release number/serial number as well as all license numbers relating to the product have to be cited.

### **Note**

This document is partially protected by copyright. It may not be changed or copied, and it may not be used without purchasing or written permission from the copyright owner (Minebea Intec). The use of this product constitutes acceptance by you of the abovementioned provisions.

## Table of contents

<b>1</b>	<b>Introduction.....</b>	<b>3</b>
1.1	Read the manual.....	3
1.2	This is what operating instructions look like.....	3
1.3	This is what lists look like.....	3
1.4	This is what menu items and softkeys look like.....	3
1.5	This is what the safety instructions look like.....	3
<b>2</b>	<b>Safety instructions.....</b>	<b>5</b>
2.1	General information.....	5
2.2	Incoming goods inspection.....	5
2.3	Before operational startup.....	5
2.3.1	Danger of explosion.....	5
2.3.2	IP protection.....	5
2.3.3	Storage and transport conditions.....	6
2.4	Failure and excessive stresses.....	6
<b>3</b>	<b>Device installation.....</b>	<b>7</b>
3.1	Mechanical preparation.....	7
3.1.1	Ambient conditions.....	7
3.1.2	Installation location.....	7
3.1.3	Unpacking.....	7
3.1.4	Checking the equipment supplied.....	8
3.1.5	Leveling the weighing platform.....	8
3.1.6	Acclimatizing the device.....	9
3.2	Connection.....	9
3.2.1	Power supply.....	9
3.2.2	Connections.....	10
3.3	Indicator holder.....	10
<b>4</b>	<b>Device description.....</b>	<b>11</b>
4.1	Display and operating elements.....	11
4.1.1	Overview.....	11
4.1.2	Display elements.....	11
4.1.3	Operating elements.....	12
<b>5</b>	<b>Operating.....</b>	<b>14</b>
5.1	Basic functions.....	14
5.1.1	Switching on the device.....	14
5.1.2	Switching off the device.....	14
5.1.3	Adjusting the GEO setting.....	14
5.1.4	Increment d.....	14

5.1.5	Select application program .....	14
5.2	Application programs .....	15
5.2.1	Weighing application .....	15
5.2.2	Counting application .....	17
5.2.3	Checking application .....	20
5.2.4	Totalizing application and statistics mode .....	28
5.3	Menu.....	32
5.3.1	Accessing the menu.....	33
5.3.2	Menu navigation .....	34
5.4	Calibration and adjustment .....	41
5.4.1	[CAL] calibration.....	41
5.4.2	[LIN] linearization .....	43
5.4.3	[GEO] geographic data (calibration location).....	46
5.4.4	GEO code table.....	48
5.5	SBI interface .....	49
<b>6</b>	<b>Maintenance/repairs/cleaning.....</b>	<b>52</b>
6.1	Repairs.....	52
6.2	Cleaning .....	52
6.2.1	Instructions for cleaning.....	52
6.2.2	Cleaning agents.....	52
<b>7</b>	<b>Waste disposal policy .....</b>	<b>53</b>
<b>8</b>	<b>Error correction .....</b>	<b>54</b>
8.1	Service information .....	54
<b>9</b>	<b>Technical data .....</b>	<b>55</b>
9.1	Specification .....	55
9.2	Accessories .....	56
9.3	Dimensions .....	57
<b>10</b>	<b>Appendix .....</b>	<b>62</b>
10.1	Printouts .....	62
10.2	FCC notice .....	62

# 1 Introduction

## 1.1 Read the manual

- Please read this manual carefully and completely before using the product.
- This manual is part of the product. Keep it in a safe and easily accessible location.

## 1.2 This is what operating instructions look like

1. - n. are placed before steps that must be done in sequence.
  - ▶ is placed before a step.
  - ▷ describes the result of a step.

## 1.3 This is what lists look like

- indicates an item in a list.

## 1.4 This is what menu items and softkeys look like

[ ] frame menu items and softkeys.

**Example:**

[Start]- [Applications]- [Excel]

## 1.5 This is what the safety instructions look like

Signal words indicate the severity of the danger involved when measures for preventing hazards are not followed.

### **DANGER**

#### **Warning of personal injury**

DANGER indicates death or severe, irreversible personal injury which will occur if the corresponding safety measures are not observed.

- ▶ Take the corresponding safety precautions.

### **WARNING**

#### **Warning of hazardous area and/or personal injury**

WARNING indicates that death or severe, irreversible injury may occur if appropriate safety measures are not observed.

- ▶ Take the corresponding safety precautions.

### **CAUTION**

#### **Warning of personal injury.**

CAUTION indicates that minor, reversible injury may occur if appropriate safety measures are not observed.

- ▶ Take the corresponding safety precautions.

**NOTICE****Warning of damage to property and/or the environment.**

NOTICE indicates that damage to property and/or the environment may occur if appropriate safety measures are not observed.

- ▶ Take the corresponding safety precautions.
- 

**Note:**

User tips, useful information, and notes.

---

## 2 Safety instructions

### 2.1 General information

- The device may only be used as intended for weighing tasks.
- Observe the operating limits of the device.
- Do not apply loads that exceed the capacity of the scale.
- Before connecting or disconnecting electronic peripheral devices, disconnect the device from the mains or from the data interface.
- Unplug the power cord from the mains supply before cleaning.
- Unplug the power cord from the mains supply before maintenance; only establish internal connections when disconnected from the power supply.
- Make sure that no liquid enters the device.

### 2.2 Incoming goods inspection

Check the contents of the consignment for integrity. Check the contents visually to determine whether any damage has occurred during transport. If there are grounds for rejection of the goods, a claim must be filed with the carrier immediately. A Minebea Intec sales or service organization must also be notified. Visit our website <http://www.puroscales.com> or contact your dealer.

### 2.3 Before operational startup

#### NOTICE

##### **Perform visual inspection.**

Before operational startup as well as after storage or transport, inspect the product visually for signs of mechanical damage.

- The product should not be put into operation if it displays signs of visible damage and/or is defective.

#### 2.3.1 Danger of explosion

Do not use the device in hazardous areas.

#### 2.3.2 IP protection

The indicator fulfills protection grade IP43.

The load cells fulfill protection grade IP67.

### 2.3.3 Storage and transport conditions

#### NOTICE

##### Material damage is possible.

Unpacked devices may lose their precision due to strong vibrations; strong vibrations may impair the safety of the device.

- ▶ Do not subject the device to extreme temperatures, moisture, shocks, and vibrations.

#### ⚠ CAUTION

##### Risk of injury!

If the load plate is lifted using a suction lifting tool, wear gloves, safety shoes, and safety clothing.

- ▶ This work may only be carried out by reliable personnel who have been assigned to the task.

#### ⚠ CAUTION

##### Warning of personal injury.

Do not walk under the load if transporting or lifting the weighing platform/load plate using a crane.

- ▶ Observe the relevant accident prevention regulations.
- ▶ Do not damage the terminal box or the load receptor during transport.

Weighing platforms from a size of 1 + 1 m are equipped with suspension points.

### 2.4 Failure and excessive stresses

If the device or the power cord display visible damage: Disconnect the power supply and secure the device to prevent it being used further.

Do not unnecessarily subject the device to extreme temperatures, corrosive chemical vapors, moisture, shocks, and vibrations.

Extreme electromagnetic influences can affect the display value. Once the disturbance has ceased, the product can be used again as intended.



## 3 Device installation

### 3.1 Mechanical preparation

#### 3.1.1 Ambient conditions

- Only use within buildings.
- Operating temperature: -10°C to +40°C
- Storage temperature: -20°C to +50°C
- Relative humidity: 20% to 85%, non-condensing
- Altitude: up to 3,575 m

#### 3.1.2 Installation location

- Place the device on a stable, flat surface.
- Position the device so that the power plug is freely accessible and the power cord does not present an obstacle or trip hazard.

Avoid unsuitable influences at the installation location:

- Extreme temperatures and excessive temperature fluctuations
- Heat due to proximity to heaters or due to direct sunlight
- Aggressive chemical vapors
- Extreme moisture
- Extreme vibrations

#### 3.1.2.1 Shock resistance

##### **NOTICE**

**Falling objects, side impacts, and shock loads may affect the performance and the accuracy of the scale and damage the platform.**

- ▶ Avoid shock loads!

#### 3.1.3 Unpacking

**The following applies for devices from a platform size of 60 x 80 cm:**

- ▶ Wear protective clothing (safety shoes and, if necessary, gloves)

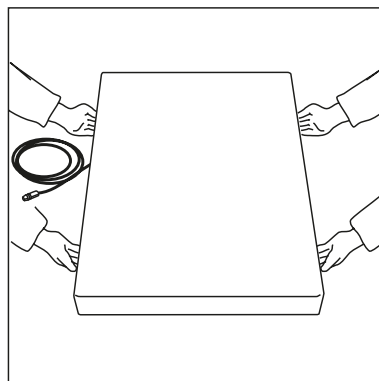

- ▶ When lifting or transporting the weighing platform, always lift it by its longest sides.

- ▶ Unpack the device and check it for visible external damage.
  - ▷ If there is damage, follow the instructions in the chapter "Safety check".
- ▶ Keep the original packaging in case the device needs to be returned. Remove all cables before sending.

### 3.1.4 Checking the equipment supplied

- 1 indicator
- 1 floor platform
- Safety instructions and QR code for access to the complete documentation

### 3.1.5 Leveling the weighing platform

To achieve reproducible weighing results at all times, the weighing platform must be set up to be precisely horizontal.

Therefore the weighing platform must be re-leveled every time it is moved to a different location.

#### Leveling the weighing platform

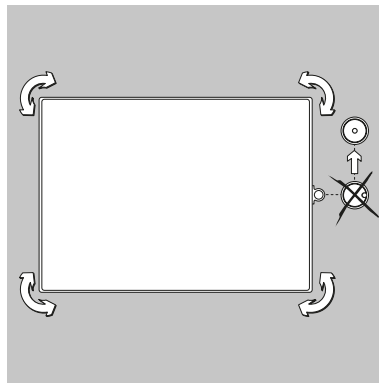

- ▶ Use the adjustable feet to align the weighing platform so that the air bubble of the level indicator is in the center of the circle.
- ▶ Check that all four of the adjustable feet are touching the surface.
  - ▷ The weight of the platform must be spread equally across the adjustable feet.
- ▶ Adjust the adjustable feet: Retract the adjustable feet (clockwise) in order to lift the scale. Extend the adjustable feet (counter-clockwise) in order to lower the scale.

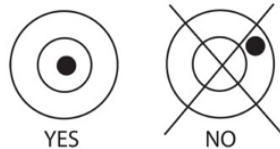

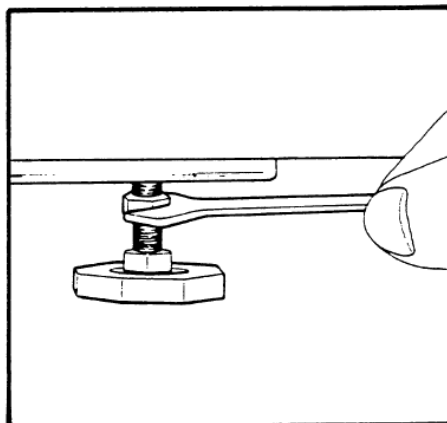

### 3.1.6 Acclimatizing the device

If a cold device is brought into a warm environment, condensation may form.

- Keep the device disconnected from the mains and allow it to acclimatize at room temperature for approx. two hours.

## 3.2 Connection

### 3.2.1 Power supply

AC power is used to power the scale when battery power is not needed.

Plug the USB-C plug into the USB-C jack on the bottom of the unit, then plug the AC power supply into a wall outlet.

---

**Note:**

Do not use the USB-C power supply cable for the PC communication. Instead use a standard USB-C cable.

---





#### 3.2.1.1 Battery power

The scale can be operated immediately with the power supply. In order to operate the scale with the battery, the battery should first be charged for 12 hours. If there is a power outage or if the power cord is disconnected, the scale switches into battery operation automatically. In the event of supply via a power supply, the battery is constantly charged meaning that the battery charging display (see Chapter [4.1.2](#)) is continuously illuminated. The scale can be used during the charging process; the battery is protected against excess charging.

When the device is switched on, the battery status LED illuminates in red while the battery is charging, and it goes green when the battery is fully charged.

The battery must be charged in a dry environment. For a maximum operating time, the battery should be charged at room temperature.

During battery operation, the battery icon displays the battery's remaining charge status. The display switches off automatically when the batteries are empty.

Icon	Charge status
	0 to 10% remaining
	11 to 40% remaining
	41 to 70% remaining
	71 to 100% remaining

**Note:**

If the battery icon flashes rapidly, then there is around 30 minutes of working time left.  
When [lo.bat] is displayed, the scale switches off.

**⚠ WARNING****Danger of explosion**

If the rechargeable battery is replaced with a battery of the wrong type, or if it is not connected correctly, then there is a danger of explosion.

- ▶ The battery may only be replaced with the same type by an authorized Puro® service dealer.
- ▶ The battery must be disposed of according to the locally valid laws and regulations.

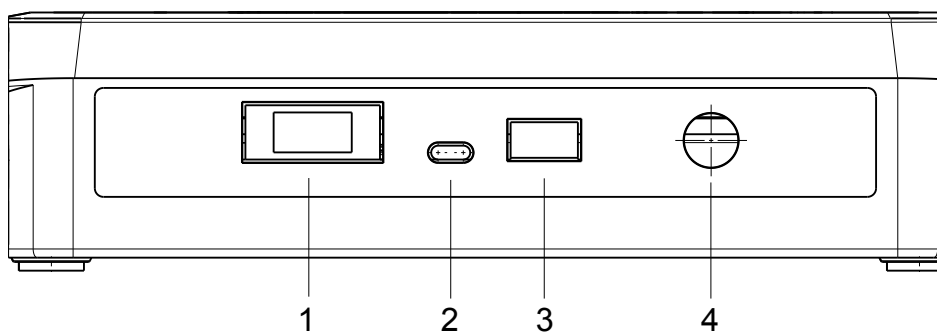
**3.2.2 Connections**

Pos.	Description
1	Accessories
2	DC IN USB-C
3	Printer port
4	LC (load cell)

**3.2.2.1 Connecting a printer**

A printer can be connected via the printer port on the side of the indicator.

**3.3 Indicator holder**

Align the holder using the threaded holes on the side of the indicator and install the knobs. Set the indicator at the desired angle and tighten the knobs.

## 4 Device description

### 4.1 Display and operating elements

#### 4.1.1 Overview

Control panel (front) with LCD display.



No.	Description
1	Display elements, see Chapter 4.1.2.
2	Operating elements, see Chapter 4.1.3.

#### 4.1.2 Display elements

LCD display

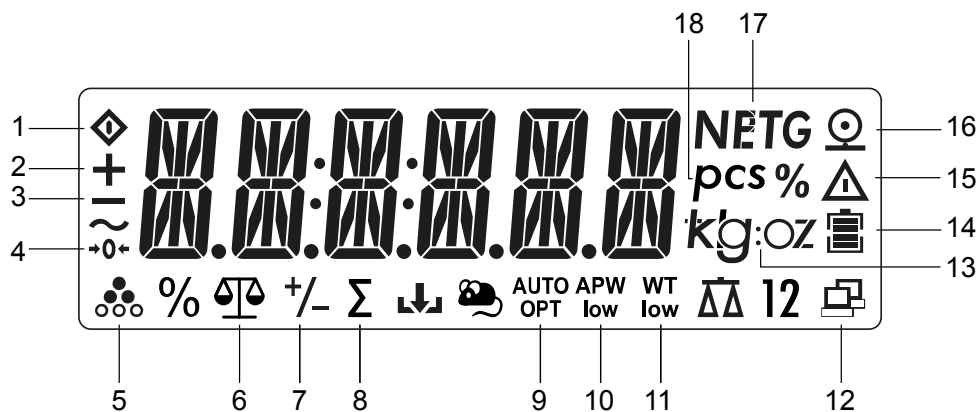

Item	Description	Item	Description
1	Busy (process running)	10	Average sample weight too low
2	Plus sign	11	Sample weight too low
3	Minus sign	12	Data transmission
4	1/4 d range around zero	13	Selected weight unit
5	Counting application active	14	Battery charging
6	Weighing application active	15	Warning icon: Displayed value is not a measured weight value
7	Checking application active	16	Printer icon

Item	Description	Item	Description
8	Totalizing application active	17	Tare active, tare value is displayed
9	Scale tares automatically	18	Item (value in items)

**LED displays**



The battery status LED (1)

- Illuminates red while the battery is being charged
- Illuminates green if the battery is fully charged.





The colored LEDs (2) on the right-hand side of the control panel are displays for the Checking application (see Chapter 5.2.3):

High	Sample > upper limit value	Red LED illuminates.
OK	Sample is within the tolerance limits	Green LED illuminates.
Low	Sample < lower limit value	Yellow LED illuminates.

**4.1.3 Operating elements**

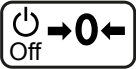

<b>Key</b>					
<b>Primary function</b>	<b>On/Zero</b>	<b>Tare</b>	<b>M+</b>	<b>Function</b>	<b>Print</b>

Key					
(Brief press) < 1 second	Switch on the scale (if the scale is switched off). Zero scale (if the scale is switched on).	Set tare	Totalizing Display weight or totaled values.	Call up applications	Send the current value to the selected COM ports if the "Out" option is specified for automatic printing.
Secondary Function	Off	Menu	Mode	Unit	
(Extended press) > 2 seconds	Switch off the scale	Delete function for totalizing.	Accessing the menu	Changing the application	Changing the weight unit.
Menu function	Yes (Confirm)	Exit	Back	No (Reject)	
(Brief press) < 1 second	Confirm display.	Exit menu. Cancel calibration process. Go to the previous digit.	Go to the previous menu items. Reduce digit value.	Discard current setting in the display and switch to the next available setting. Go to the next menu item. Increase digit value.	

## 5 Operating

### 5.1 Basic functions

#### 5.1.1 Switching on the device

- ▶ Press the  key.
  - ▷ Whenever it is switched on, the device performs a self-test. This will display all display segments for a few seconds.

All indicator LEDs illuminate.

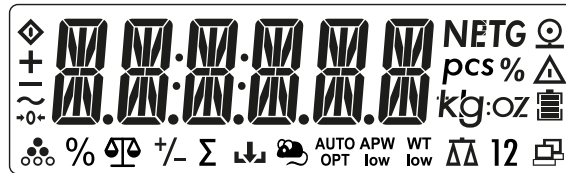

Then the software version number is briefly displayed.

The scale starts with the application that was active before it was last switched off.

If the scale is switched on for the first time, the weighing and totalizing (manual) applications are active.

#### 5.1.2 Switching off the device

- ▶ Press and hold the  key until [OFF] is displayed.
  - ▷ [- OFF -] is displayed briefly in the display.

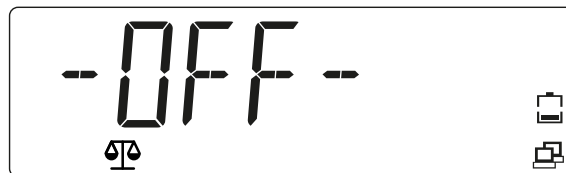

The device switches off, the display goes dark.

#### 5.1.3 Adjusting the GEO setting



Adjust the GEO setting according to the location in order to guarantee accurate weighing results. See Chapter [5.4.3](#).

#### 5.1.4 Increment d

"d" stands for the lowest weight value that can be displayed.

Example  $d = 0.02 \text{ g} \rightarrow 2 d = 0.04 \text{ g} \rightarrow 3 d = 0.06 \text{ g}$

#### 5.1.5 Select application program

- ▶ Press and hold the  key.
  - ▷ The names of the applications are each displayed for 2 seconds until the  key is released.

Releasing the  key will select and start the displayed application.

Possible applications are:





[WEIGHT]	Weighing
[COUNT]	Counting
[CHECK]	Checking
Selectable applications (selection in the menu, see Chapter 5.3.2.1):	- Check Weighing - Check Counting

The Totalizing, Automatic Tare, and Automatic Printing applications can be activated in the menu.

[OP.FUNC]		
	[A.TARE]	Automatic tare
	[TOT.SET]	Totalizing
[PRINT]		
	[A.PRINT]	Automatic printout

## 5.2 Application programs

### 5.2.1 Weighing application

- To select the Weighing application, press and hold the  key until [WEIGHT] (weighing) is displayed at the lower edge of the display with the application icon .



Release the key. The application is activated.

- ▷ [0.000] is shown.



- Place the sample on the load plate (in this example: 0.598 kg).

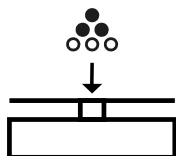

- ▷ The weight of the sample is displayed with the unit symbol (here [kg]).



### 5.2.1.1 Set tare

- ▶ Place the empty container on the load plate.

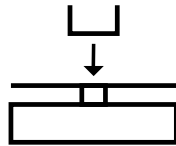

- ▷ The tare weight of the container is displayed:



- ▶ Press the  (Tare) key to save the tare weight.
- ▷ [0.000 kg] and [NET] (net value) is displayed:



The scale has been tared. The tare weight remains saved until it is deleted or overwritten with a new weight.

### 5.2.1.2 Weight unit

The weight value can be displayed in various weight units:

[kg / g / lb / oz / lb:oz]

Select weight unit:

- ▶ Press the  (unit) key until the desired weight unit is displayed. Release the key to activate the weight unit.

Possible units are:

Weight unit	Unit symbol
Gram	[g]
Kilogram	[kg]
Pound	[lb]
Ounce	[oz]
Pound-ounce	[lb:oz]

**Note:**

Weight units must be activated in the menu in order to be able to be called up via the  (unit) key. See Chapter [5.3.2.3](#).

**5.2.1.3 Stable weight value**

A stable weight value is displayed with the unit symbols (e.g. [kg]).

Stable weight value:

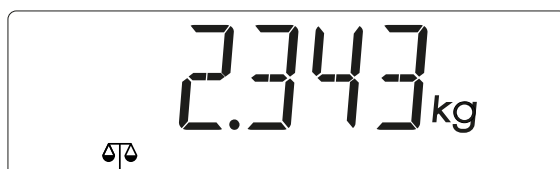

A non-stable weight value is displayed without the unit symbols.

Non-stable weight value:

**5.2.1.4 Negative weight value**

A negative stable net weight value is displayed with the unit symbols (e.g. [kg]):



A negative (stable or unstable) gross weight value is displayed without unit symbols:



If the gross weight 20 d is below zero, [L] is displayed.

If the gross weight 7 d is above the max. capacity, [H] is displayed.



**5.2.2 Counting application****Note:**

The application must be activated in the menu. See Chapter [5.3.2.1](#).

In the Counting application it is possible to determine the quantity of parts with approximately the same weight. For this purpose, the average sample weight is calculated from a known reference quantity and saved as the reference sample weight.

Example: Use a known number of parts (reference quantity) to determine an unknown number of parts.

If counting needs to be carried out into a container, tare the container.



1. To select the Counting application, press the  key until [COUNT] (Counting) is displayed at the lower edge of the screen with the application icon .

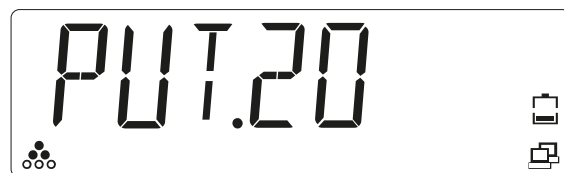

Release the key. The application is activated.

2. [PUT 20] (apply 20 parts) is displayed.<sup>1)</sup>



3. Select the desired reference quantity (10, 20, 50, 100, 200) by briefly pressing the  (decrease in increments) key or the  (increase in increments) key.
4. Press the  (Yes) key to save the selected reference quantity.
  - ▷ If the load plate is empty, [PUT.PW] (apply reference weight) is displayed in the display.



5. Place the number of parts (reference quantity, in this example 20) on the load plate.

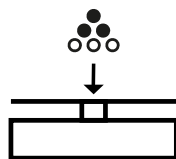

6. Press the  (Yes) key to save the average sample weight.
  - ▷ [PW.OK] (reference weight confirmed) is briefly displayed in the display.<sup>2)</sup>

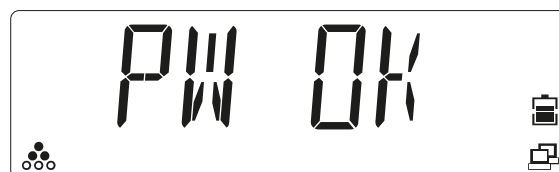

7. Counting is initialized. The currently applied quantity is displayed in the display: e.g. [20 pcs].



8. Place the sample (parts to be counted) on the load plate.
- ▷ The number of parts applied ([pcs]) is displayed. The warning symbol  $\triangle$  indicates that the displayed value is not a weight value.

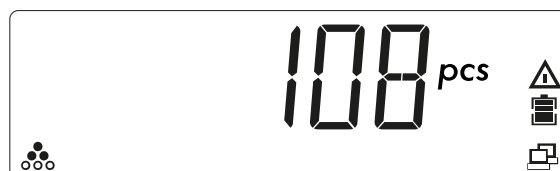

9. To count parts that are removed from a container, after initializing the sample weight, place the container with the items to be counted on the scale and press the  $\rightarrow T \leftarrow$  (Tare) key.
10. In order to display the saved reference sample weight, briefly press the  $\text{F Mode}$  key.
- ▷ The scale briefly displays [REF.WT] (reference weight) and then the saved reference sample weight.



**Note:**

1) If a reference sample weight is already saved, [CLR.PW] (delete reference sample weight) will be displayed.



In order to use the saved reference sample weight, press the  (No) key.

In order to delete the saved reference sample weight and replace it with a new sample weight, press the  (Yes) key.

If the reference weight is low ( $<$  reference sample weight AND calculated reference sample weight  $\geq 2 d/10$ ), then [LOW.REF] is displayed for 2 seconds. Increase the reference weight or proceed with step 7.

If [LOW.REF] is briefly displayed in the display, then the weight on the load plate is too low in order to achieve the desired accuracy.

2) If [REF.ERR] is briefly displayed in the display, then the applied weight is  $< 2 d$  or the calculated sample weight is  $< 2 d/10$ . Proceed with step 5.



### 5.2.3 Checking application

Using the "Checking" application, it is possible to determine whether a sample matches a specified weight value or lies within set tolerance limits.

The scale supports positive check weighing, negative check weighing and check against zero.

#### Positive check weighing

Using the positive Check Weighing application, it is possible to determine an upper and lower limit value and check if the sample lies within the specified tolerance limits.

In this case, the value for upper limit and lower limit must be a **positive** value.

**The upper limit must be greater than the lower limit.**

Place the sample on the load plate until it is within the specified tolerance limits (green).

#### Negative check weighing

Using the negative Check Weighing application, it is possible to determine an upper and lower limit value and check if the sample removed from the scale lies within the specified tolerance limits.

In this case, the value for upper limit and lower limit must be a **negative** value.

**(The lower limit must be greater than the upper limit, i.e. lower limit = -10/upper limit = -15).**

Place the sample on the load plate and press the  key.

Remove part of the sample until it is within the specified tolerance limits (green).

**Check against zero** Using the Check Against Zero application, it is possible to check the sample as a difference from the reference weight. In this case the lower limit must be a **negative** value and the upper limit must be a **positive** value or zero.

Place the reference weight on the load plate and press the  key. Remove the reference weight and place the sample to be measured on the scale in order to determine whether it is within the specified tolerance limits (green).

It is also possible to check a precise partial weight value. In this case, the values for upper limit and lower limit must be **the same**. The various applications for checking must be activated in the menu (see Chapter 5.3.2.1).



### 5.2.3.1 Check Weighing application

**Note:**

The application must be activated in the menu. See Chapter 5.3.2.1.

Using the Check Weighing application, it is possible to determine an upper and lower limit value and display if the sample lies within the specified tolerance limits.

Example: The limit values are specified as 1 kg (lower limit) and 1.1 kg (upper limit).



- To select the Check Weighing application, press and hold the  key until [CHECK] (checking) is displayed with the application icons  and .

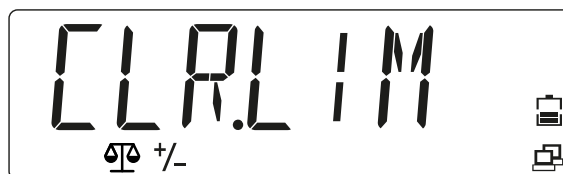

Release the key. The application is activated.

- ▷ If limit values are already saved in the device, [CLR.LIM] (delete limit values) will be displayed and all indicator LEDs will illuminate.



- In order to use the saved limit values, press the  (No) key. Proceed with step 11.  
Or:
- In order to specify new limit values, press the  (Yes) key.
  - ▷ [SET.LOW] (specify lower limit) is displayed and the yellow LED for the lower limit illuminates.





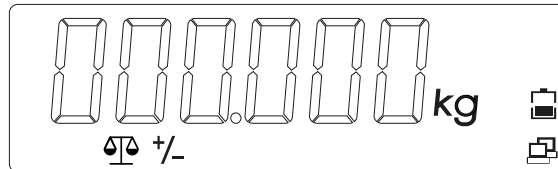

4. Press the  (Yes) key to change the value for the lower limit.  
 ▷ The value for the lower limit is displayed using flashing digits in the display: [000.000] (in this example 0.000 kg).



5. Press the  (No) key to change the value.  
 ▷ The first digit flashes: [\_00.000].



6. Enter the value for the lower limit: Press the  key in order to increase the value. Press the  key in order to decrease the value. To move to the next digit, press the  (Yes) key; to go to the previous digit, press the  (End) key.

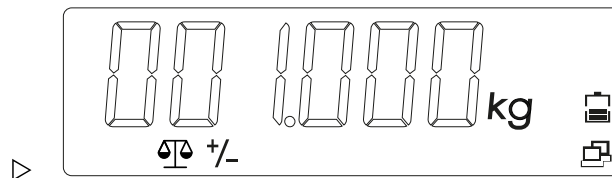

7. If all digits are flashing at the same time, press the  (Yes) key to save the value for the lower limit.  
 ▷ [SET.HI] (specify upper limit) is displayed in the display.

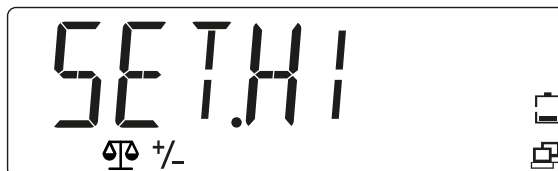

8. Enter the value for the upper limit. (Procedure as in steps 5 to 7)  
 ▷ If the limit values have been validly defined, the scale is ready for the Check Weighing application within the defined tolerance limits.<sup>1)</sup>





9. Place the container on the load plate (in this example: 0.527 kg).
10. To tare the container, press the →T← (Tare) key until [0 kg] and [NET] are displayed.



11. Place the sample in the container.
  - ▷ The indicator LEDs indicate whether the weight of the sample is below, within, or above the tolerance limits.

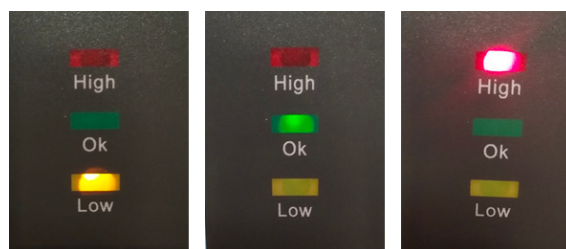

Sample < lower limit value	Yellow LED illuminates.
Sample is within the tolerance limits	Green LED illuminates.
Sample > upper limit value	Red LED illuminates.

In order to display the currently defined limit values (in this example the value for the lower limit is 1 kg and the value for the upper limit is 1.100 kg), the F Mode key can be pressed briefly at any time during the check weighing.

The scale displays the value for the lower limit when the yellow LED briefly illuminates and the value for the upper limit when the red LED briefly illuminates.



**Note:**

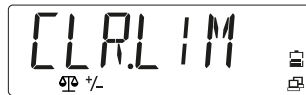

1) If [LIM.ERR] (limit value error) is briefly displayed followed by [CLR.LIM] (delete limit value), then invalid limit values have been defined. Repeat the setup process.

**5.2.3.2 Check Counting application****Note:**

The application must be previously activated in the menu. See Chapter [5.3.2.1](#).

The Check Counting application can be used to determine whether the quantity of the sample is within specified tolerance limits.

Example: The limit values for the tolerance limits are specified as 500 items (lower limit) and 510 items (upper limit).



1. In order to select the Check Counting application or to restart with new limit values, press and hold the  key until [CHECK] (checking) is displayed at the lower edge of the screen with the application icons  and .







Release the key. The application is activated.

If a reference sample weight is already saved, [CLR.PW] (delete reference sample weight) will be displayed.



2. Press the  (No) key in order to use the saved reference sample weight (PW), and proceed with step 11.  
or
3. Press the  (Yes) key in order to delete the saved reference sample weight (PW), and specify a new sample weight.  
▷ [PUT.20] (for example) is displayed on the display.



4. Press the desired reference quantity by briefly pressing the  (decrease in increments) key or the  (No) (increase in increments) key in order to switch between the selection options [10, 20, 50, 100, 200].
5. Press the  (Yes) key to confirm the reference quantity.
  - ▷ If the load plate is empty, [PUT.PW] (apply reference weight) is displayed in the display.
6. Place the desired reference quantity on the load plate or in the container and press the  (Yes) key in order to determine and save the new reference sample weight.

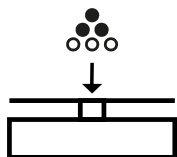



- ▷ If there are reference sample weights on the load plate, [PW OK] (adopt sample weight) is displayed in the display for 2 seconds, then [CLR.LIM] (delete limit values).<sup>1)</sup>



If there is no reference sample weight on the load plate or the weight is less than 2 d, [REF.ERR] (reference error) is briefly displayed in the display. Apply higher sample weights.



7. In order to specify new limit values, press the  (Yes) key. Or: in order to use the saved limit values, press the  (No) key and proceed with step 16.
  - ▷ [SET.LOW] (specify lower limit) is displayed on the scale.





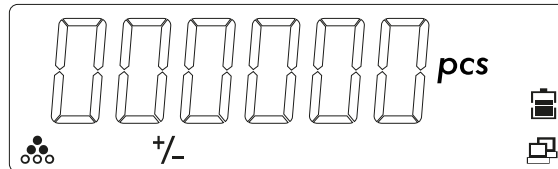

8. Press the  (Yes) key to enter the lower limit.  
 ▷ The saved lower limit is displayed using flashing digits in the display: [000000] (in this example 0 items).



9. Press the  (No) key to change the value.  
 ▷ The first digit flashes: [ \_00000].



10. Enter the value for the lower limit: Press the  key in order to increase the value. Press the  key in order to decrease the value. To move to the next digit, press the  (Yes) key; to go to the previous digit, press the  (End) key.  
 ▷ The value for the lower limit is displayed using flashing digits in the display: [000500] (here 500 parts).

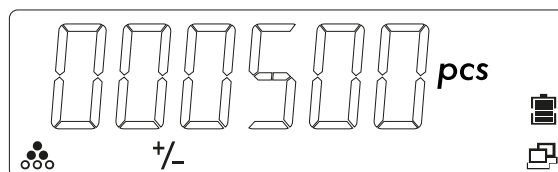

11. Press the  (Yes) key to confirm the value for the lower limit.  
 [SET.HI] (specify upper limit) is displayed in the display.

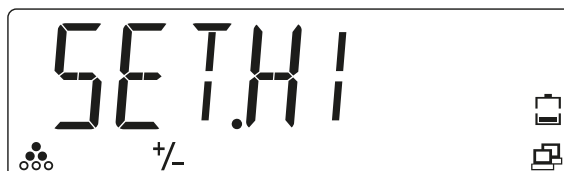

12. Enter the value for the upper limit. (Procedure as in steps 5 to 10)  
 ▷ The value for the upper limit is displayed using flashing digits in the display: [00510.0] (here 510 parts).

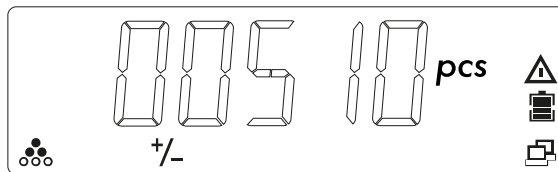

13. Press the  (Yes) key to confirm the value for the upper limit.

▷ The scale can now be used for the Check Counting application within the specified limit values.

If the limit values defined are invalid, [LIM.ERR] (limit value error) is displayed briefly, followed by [CLR.LIM] (delete limit value).



Perform the setup process again.

14. Place the container on the load plate (in this example: 109 items).

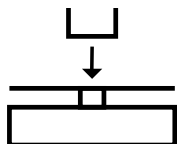

15. To tare the container, press the  (Tare) key. [NET] is displayed next to the weight value.



16. Place the sample in the container.

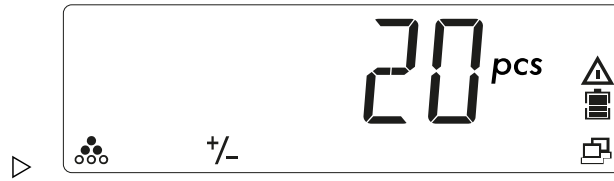

The LEDs indicate whether the sample is within the limit values.

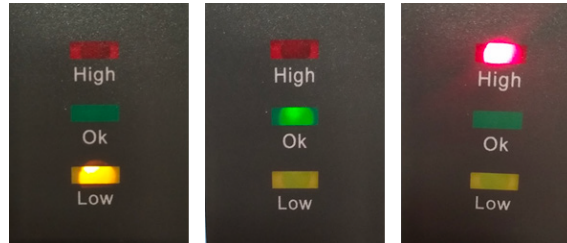

Sample < lower limit value	Yellow LED illuminates.
Sample is within the tolerance limits	Green LED illuminates.
Sample > upper limit value	Red LED illuminates.

17. In order to display the currently defined limit values (here the value for the lower limit is 500 parts and the value for the upper limit is 510 parts), the  $\left[ \begin{smallmatrix} F \\ \text{Mode} \end{smallmatrix} \right]$  key can be pressed briefly at any time during the Check Counting application.

- ▷ The display shows the value for the lower limit when the yellow LED briefly illuminates and the value for the upper limit when the red LED briefly illuminates.

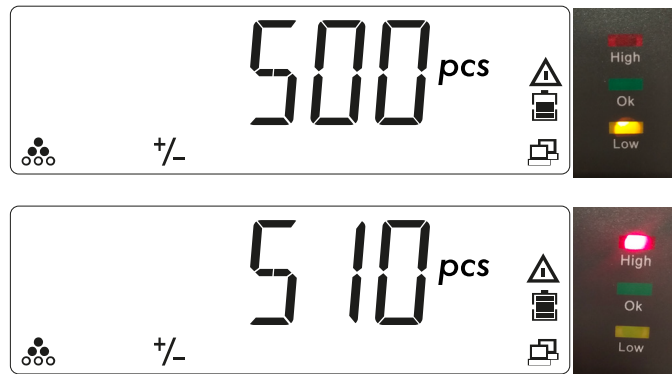

## 5.2.4 Totalizing application and statistics mode

With the Totalizing application, it is possible to manually or automatically add together values in the totalizing memory. In addition to the total, the number of items totalized is also saved.

Statistics data (total value, minimum/maximum weight, parts, and total weighed objects) are saved for testing and printing. The totalizing function is available in every application. Manual totalizing is activated as standard.

### 5.2.4.1 Setting up the Totalizing application



1. To access the menu mode, press and hold the  $\left[ \begin{smallmatrix} M+ \\ \text{Menu} \end{smallmatrix} \right]$  key until [M.E.N.U] is displayed.



Release the key.

- ▷ The first menu item [APPLIC] (application) is shown in the display.







2. Press the  (No) key in order to access the next menu item, or press the  key to access the previous menu item.
3. Repeat until [OP.FUNC] (operating function) is shown in the display.



4. Press the  (Yes) key to access the sub-menu item.
5. Repeat until [TOT.SET] (Totalizing) is displayed.



6. Press the  (Yes) key to access the sub-menu, then use the  key to select one of the options [OFF / AUTO / MAN] (off/automatic/manual) and save the selection using the  (Yes) key.
7. Press the  key to exit the menu.

#### 5.2.4.2 Totalizing weight values

The Totalizing application is activated when the  $\Sigma$  icon is displayed.



1. Place the first weight on the scale.

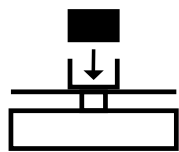

2. Press the **M+ Menu** key to add the weight to the totalized data (manual mode).

OR

The weight value is automatically added to the totalized data as soon as the measured value is stable (automatic mode).

The  $\Sigma$  icon flashes until the weight is removed.

3. Empty the load plate.

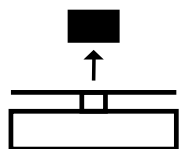

The weight must be removed from the load plate in order for the next weight to be able to be added to the totalized data.



4. Place another weight on the scale and repeat the process (automatic or manual mode).

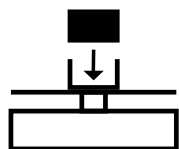

- ▷ The  $\Sigma$  icon flashes until the weight is removed.

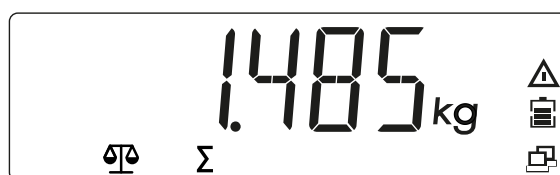

### 5.2.4.3 Displaying and deleting statistics data



Requirement: In order to display saved statistics, there must not be a load on the scale.

1. Empty the load plate.

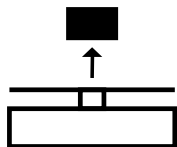

2. Press the **M+ Menu** key in order to display the saved totalized data.

The statistics information is displayed in the display in the following order:

Number of weighings carried out (N = 7):

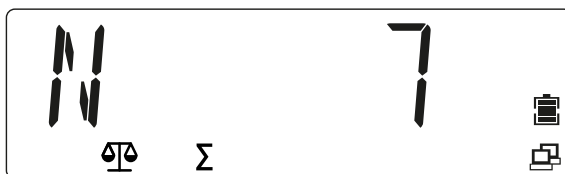

Totalized value (total = 5.225 kg)

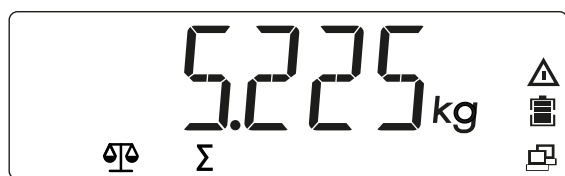
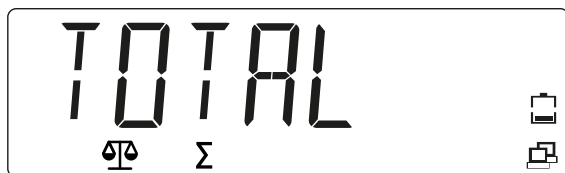

Minimum value (min = 0.470 kg):

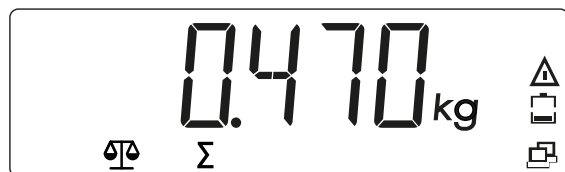
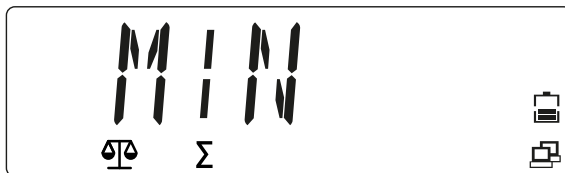

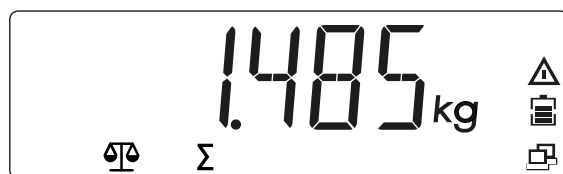
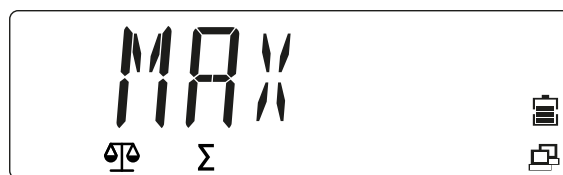

Maximum value (max = 1.485 kg)



Deleting the totalizing memory:

3. Press and hold the  key while there is no load on the load plate and the totalized data are displayed.
  - ▷ The message [CLR.TOT] is displayed.



4. To confirm the message, press the  (Yes) key; to cancel the process, press the  (No) key.

Check whether the totalizing memory has been deleted:

5. Press the  key in order to display the statistics information.

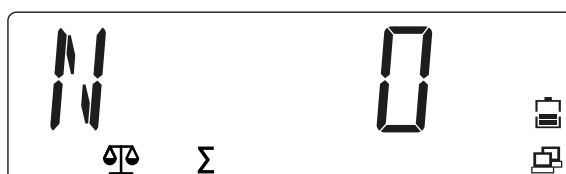

#### Note:

- The object must be removed from the load plate in order for the next weight to be able to be added to the totalized data.
- Only stable weights are saved.
- When calling up another application, the totalizing memory is deleted.
- Gross weights and net weights cannot be added to the same total.
  - If the first weight is a gross weight, the following weights must also be gross weights.
  - If the first weight is a net weight, the following weights must also be net weights.

## 5.3 Menu

The scale settings can be adjusted in the user menu (menu mode).

**Note:**

If appropriate interface options are installed, additional sub-menus may be available. Information on this can be found in the manual for the interface used.

**5.3.1 Accessing the menu**

1. Press and hold the  key until [M.E.N.U] is displayed.

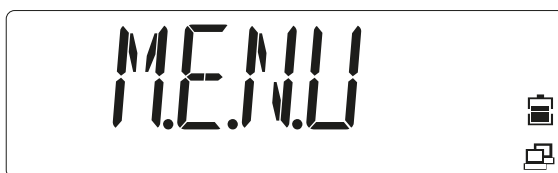



Release the key.

- ▷ The first menu item [APPLIC] (application) is shown in the display.



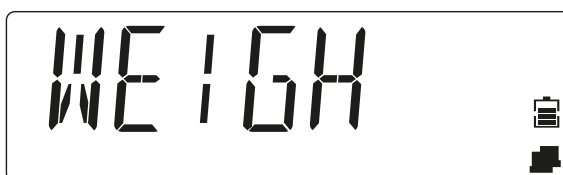

2. To call up a menu item (in this example [APPLIC]- [WEIGH]), press the  (Yes) key.



3. Or: Press the  key in order to go to the next menu item, or press the  key to go to the previous menu item.

- ▷ The second menu item [METRO] is shown in the display.



4. When the setting is displayed (in this example [METRO]- [STAB.RA] value 0.5 d), press the  (Yes) key in order to adopt the setting, or the  (No) key in order to change the setting. The current selection is marked with [◦].



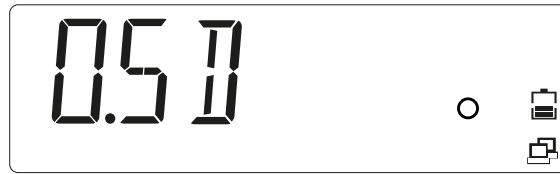

- When [END] is displayed, press the (Yes) key in order to return to the options from the sub-menu.



- Press the (No) key to return to the first item in the current menu.
- Press the key to exit the menu.

### 5.3.2 Menu navigation

Overview of the options of the menu mode:

— <b>APPLIC</b>	Application (see Chapter <a href="#">5.3.2.1</a> )
— <b>METRO</b>	Metrology (see Chapter <a href="#">5.3.2.2</a> )
— <b>UNIT</b>	Weight units (see Chapter <a href="#">5.3.2.3</a> )
— <b>OP.FUNC</b>	Operating functions (see Chapter <a href="#">5.3.2.4</a> )
— <b>PRINT</b>	Printer outputs (see Chapter <a href="#">5.3.2.5</a> )
— <b>PRN.COM</b>	Printer port communication (see Chapter <a href="#">5.3.2.6</a> )
— <b>PC.OUT</b>	PC output (see Chapter <a href="#">5.3.2.7</a> )
— <b>PC.COM</b>	PC port communication (see Chapter <a href="#">5.3.2.8</a> )
— <b>CAL.ADJ</b>	Calibration/adjustment (see Chapter <a href="#">5.3.2.9</a> )
— <b>INFO</b>	Info (display of serial number and type designation)
— <b>SECURE</b>	Block menu items (see Chapter <a href="#">5.3.2.11</a> )
— <b>E.N.D.</b>	Exiting menus

#### 5.3.2.1 [APPLIC] menu selection

The application to be used can be selected in this menu.

Only activated applications can be called up using the (mode) key.

Factory settings are marked with "\*"

<b>APPLIC</b>	
— <b>WEIGH</b>	Weighing
— <b>OFF</b>	deactivated
— <b>ON</b>	activated*
— <b>COUNT</b>	Counting
— <b>OFF</b>	deactivated
— <b>ON</b>	activated*
— <b>CHECK</b>	Checking
— <b>OFF</b>	deactivated*
— <b>CHE.WEI</b>	Check Weighing activated
— <b>CHE.CNT</b>	Check Counting activated
— <b>RESET</b>	Factory settings

		NO	not reset*
		YES	activated
		END	Exit menu level

**5.3.2.2 [METRO] menu selection**

The functions of the displays and scales can be adjusted in this menu.  
Factory settings are marked with "\*"

<b>METRO</b>		
		STAB.RA
		0.5d
		1d
		2d
		4d
		FILTER
		LOW
		MED
		HI
		A.ZERO.T
		OFF
		0.5d
		1d
		3d
		AUT.OFF
		OFF
		1 MIN
		5 MIN
		10 MIN
		DYN.TIM
		5 SEC
		10 SEC
		15 SEC
		20 SEC
		25 SEC
		30 SEC
		RESET
		NO
		YES
		END
		Stability range
		1/2 d
		1 d*
		2 d
		4 d
		Adjustment filter
		Lower accuracy, short stabilization time
		Normal accuracy, average stabilization time*
		High accuracy, long stabilization time
		Automatic zero point correction
		Switching off
		Drift up to 1/2 d*
		Drift up to 1 d
		Drift up to 3 d
		Counter for automatic switching off
		Switching off*
		Switching off after 1 minute with no activity
		Switching off after 5 minutes with no activity
		Switching off after 10 minutes with no activity
		No effect in this device
		No effect in this device
		No effect in this device
		No effect in this device
		No effect in this device
		No effect in this device
		No effect in this device
		Factory settings
		not reset*
		activated
		Exit menu level

**5.3.2.3 [UNIT] menu selection**

The weight unit can be selected in this menu.

Only activated units can be called up using the  (unit) key.

Factory settings are marked with "\*"

<b>UNIT</b>		
		kg
		OFF
		ON
		g
		OFF
		ON
		lb
		Kilogram
		deactivated
		activated*
		Gram
		deactivated
		activated*
		Pound

<ul style="list-style-type: none"> <li>— OFF</li> <li>— ON</li> </ul>	<ul style="list-style-type: none"> <li>deactivated</li> <li>activated*</li> </ul>
<ul style="list-style-type: none"> <li>— oz</li> <li>— OFF</li> <li>— ON</li> </ul>	<ul style="list-style-type: none"> <li>Ounce</li> <li>deactivated</li> <li>activated*</li> </ul>
<ul style="list-style-type: none"> <li>— lb:oz</li> <li>— OFF</li> <li>— ON</li> </ul>	<ul style="list-style-type: none"> <li>Pound:ounce</li> <li>deactivated*</li> <li>activated</li> </ul>
<ul style="list-style-type: none"> <li>— RESET</li> <li>— NO</li> <li>— YES</li> </ul>	<ul style="list-style-type: none"> <li>Factory settings</li> <li>not reset*</li> <li>activated</li> </ul>
<ul style="list-style-type: none"> <li>— END</li> </ul>	<ul style="list-style-type: none"> <li>Exit menu level</li> </ul>

**5.3.2.4 [OP.FUNC] menu selection**

The scale parameters can be specified in this menu.

Factory settings are marked with "\*"

<b>OP.FUNC</b>	
<ul style="list-style-type: none"> <li>— ZERO.R</li> <li>— 2%</li> <li>— 10%</li> </ul>	<ul style="list-style-type: none"> <li>Zero range</li> <li>2% max. load</li> <li>10% max. load*</li> </ul>
<ul style="list-style-type: none"> <li>— A.TARE</li> <li>— OFF</li> <li>— ON</li> <li>— ON-ACC</li> </ul>	<ul style="list-style-type: none"> <li>Automatic tare</li> <li>deactivated*</li> <li>1st stable weight is tared</li> <li>Stable loads within the tolerance limits are tared (in the Checking application)</li> </ul>
<ul style="list-style-type: none"> <li>— BEEP.SI</li> <li>— OFF</li> <li>— ACCEPT</li> <li>— UNDER</li> <li>— OVER</li> <li>— UNDOVR</li> </ul>	<ul style="list-style-type: none"> <li>Signal (in the Checking application)</li> <li>deactivated*</li> <li>Alarm when the weight is within the tolerance limits</li> <li>Alarm when the weight is below the lower limit</li> <li>Alarm when the weight is above the upper limit</li> <li>Alarm when the weight is outside the tolerance limits</li> </ul>
<ul style="list-style-type: none"> <li>— BEEP.KE</li> <li>— OFF</li> <li>— ON</li> </ul>	<ul style="list-style-type: none"> <li>Key tone</li> <li>deactivated</li> <li>activated*</li> </ul>
<ul style="list-style-type: none"> <li>— TOT.SET</li> <li>— OFF</li> <li>— AUTO</li> <li>— MAN</li> </ul>	<ul style="list-style-type: none"> <li>Totalizing setting</li> <li>deactivated</li> <li>Automatic totalizing</li> <li>Manual totalizing*</li> </ul>
<ul style="list-style-type: none"> <li>— LIGHT.T</li> <li>— 3 SEC</li> <li>— 5 SEC</li> <li>— 8 SEC</li> </ul>	<ul style="list-style-type: none"> <li>Duration of the background lighting (D.LIGHT = AUTO)</li> <li>Switching off of the background lighting after 3 seconds with no activity</li> <li>Switching off of the background lighting after 5 seconds with no activity*</li> <li>Switching off of the background lighting after 8 seconds with no activity</li> </ul>
<ul style="list-style-type: none"> <li>— D.LIGHT</li> <li>— OFF</li> <li>— ON</li> </ul>	<ul style="list-style-type: none"> <li>Background lighting of the display</li> <li>deactivated</li> <li>activated</li> </ul>

<ul style="list-style-type: none"> <li>— AUTO</li> <li>— COM.EQU</li> <li>— OFF</li> <li>— BLUE.TH</li> <li>— WIFI</li> <li>— ETHER.N</li> <li>— RESET</li> <li>— NO</li> <li>— YES</li> <li>— END</li> </ul>	<p>Switches on when a key is pressed or the displayed weight changes*</p> <p>Communication module deactivated*</p> <p>Bluetooth activated (if the Bluetooth module is installed)</p> <p>WiFi activated (if the WiFi module is installed)</p> <p>Ethernet activated (if the Ethernet module is installed)</p> <p>Factory settings not reset*</p> <p>activated</p> <p>Exit menu level</p>
---	---

5.3.2.5 [PRINT] menu selection

Scale parameters can be printed in this menu.

Factory settings are marked with "\*"

<b>PRINT</b>	
<ul style="list-style-type: none"> <li>— STABLE</li> <li>— OFF</li> <li>— ON</li> <li>— A.PRINT</li> <li>— OFF</li> <li>— ON.STAB</li> <li>— INTER</li> <li>— 1...3600</li> <li>— CONT</li> <li>— ACCEPT</li> <li>— CONTNT</li> <li>— RESULT</li> <li>— OFF</li> <li>— ON</li> <li>— GROSS</li> <li>— OFF</li> <li>— ON</li> <li>— NET</li> <li>— OFF</li> <li>— ON</li> <li>— TARE</li> <li>— OFF</li> <li>— ON</li> <li>— HEADER</li> <li>— OFF</li> <li>— ON</li> <li>— FOOTER</li> <li>— OFF</li> <li>— ON</li> <li>— MODE</li> <li>— OFF</li> <li>— ON</li> </ul>	<p>Print criteria</p> <p>Values are printed immediately</p> <p>Values are only printed if they are stable*</p> <p>Automatic printout deactivated*</p> <p>printing on stability</p> <p>Printing in the specified interval</p> <p>1 ... 3,600 seconds</p> <p>Print continuously</p> <p>Printing on stability and within the tolerance limits</p> <p>Content of a printout</p> <p>Displayed value deactivated</p> <p>activated*</p> <p>Gross value deactivated*</p> <p>activated</p> <p>Net value deactivated*</p> <p>activated</p> <p>Tare deactivated*</p> <p>activated</p> <p>Header deactivated*</p> <p>activated</p> <p>Info on the footer deactivated*</p> <p>activated</p> <p>Info on the application mode deactivated*</p> <p>activated</p>

		<b>INFO</b>	Info on reference (CkWt, CkCount, Count)
		<b>OFF</b>	deactivated*
		<b>ON</b>	activated
		<b>TOTAL</b>	Totalizing memory/statistics data
		<b>OFF</b>	deactivated*
		<b>RESULT</b>	Totalizing memory is printed
		<b>ALL</b>	Totalizing memory/statistics data are printed
		<b>LI.SET</b>	Totalizing memory
		<b>FORMAT</b>	Format sent to printer and PC
		<b>MULTI</b>	Multi-line (single-column) printout*
		<b>SINGLE</b>	Single-line printout
		<b>FEED</b>	Setting of the paper feed
		<b>LINE</b>	One-line feed
		<b>4LF</b>	Four-line feed*
		<b>FORM</b>	Page feed after printing
		<b>RESET</b>	Factory settings
		<b>NO</b>	not reset*
		<b>YES</b>	activated
		<b>END</b>	Exit menu level

**5.3.2.6 [PRN.COM] menu selection**

The parameters for the print communication can be specified in this menu.

Factory settings are marked with "\*"

<b>PRN.COM</b>			
		<b>BAUD</b>	Baud rate
		<b>2400</b>	2,400
		<b>4800</b>	4,800
		<b>9600</b>	9,600*
		<b>19200</b>	19,200
		<b>38400</b>	38,400
		<b>57600</b>	57,600
		<b>115200</b>	115,200
		<b>PARITY</b>	Parity
		<b>7 EVEN</b>	7 data bits, even parity
		<b>7 Odd</b>	7 data bits, odd parity
		<b>7 NONE</b>	7 data bits, no parity
		<b>8 NONE</b>	8 data bits, no parity*
		<b>STOP</b>	Stop bit
		<b>1</b>	1*
		<b>2</b>	2
		<b>RESET</b>	Factory settings
		<b>NO</b>	not reset*
		<b>YES</b>	activated
		<b>END</b>	Exit menu level

**5.3.2.7 [PC.OUT] menu selection**

The parameters for the PC output can be specified in this menu.

Factory settings are marked with "\*"

<b>PC.OUT</b>			
		<b>MODE</b>	PC output mode
		<b>OFF</b>	deactivated*



—	MAN.OUT	Manual output
—	MAN.STA	Manual output, if data are stable
—	INT.OUT	Interval output
—	AUT.OUT	Automatic output
—	AUT.STA	Automatic output, if data are stable
—	INTERV	Specify output interval (if INT.OUT is selected)
—	1 CYC	Every display cycle
—	2 CYC	After 2 display cycles
—	5 CYC	After 5 display cycles*
—	10 CYC	After 10 display cycles
—	20 CYC	After 20 display cycles
—	50 CYC	After 50 display cycles
—	100 CYC	After 100 display cycles
—	RESET	Factory settings
—	NO	not reset*
—	YES	activated
—	END	Exit menu level

### 5.3.2.8 [PC.COM] menu selection

The parameters for the PC communication can be specified in this menu.

Factory settings are marked with "\*"

<b>PC.COM</b>		
—	BAUD	Baud rate
—	4800	4,800
—	9600	9,600*
—	19200	19,200
—	38400	38,400
—	57600	57,600
—	115200	115,200
—	PARITY	Parity
—	7 EVEN	7 data bits, even parity
—	7 Odd	7 data bits, odd parity
—	7 NONE	7 data bits, no parity
—	8 NONE	8 data bits, no parity*
—	7 MARK	7 data bits, mark parity
—	7 SPACE	7 data bits, space parity
—	STOP	Stop bit
—	1	1*
—	2	2
—	HAND.SH	Handshake
—	NONE	No handshake*
—	XON.XOF	No function
—	RESET	Factory settings
—	NO	not reset*
—	YES	activated
—	END	Exit menu level

### 5.3.2.9 [CAL.ADJ] menu selection

The scale can be calibrated and adjusted in this menu (see Chapter 5.4).

<b>CAL.ADJ</b>	
—	CAL

<ul style="list-style-type: none"> <li>— LIN</li> <li>— GEO</li> <li>— END</li> </ul>	<p>Initiates a two-point calibration (zero and max. load)</p> <p>Initiates a linearization (zero, half weighing range and max. load)</p> <p>The adjustment of the calibration based on the current location is carried out using the geographic adjustment factor (GEO). (Settings from 0 ... 31, default value = 12)</p> <p>Exit menu level</p>
---	--

**5.3.2.10 [INFO] menu selection**

<b>INFO</b>	
<ul style="list-style-type: none"> <li>— TYPE</li> <li>— SER.NUM</li> </ul>	<p>Display model name</p> <p>Display serial number</p>

**5.3.2.11 [SECURE] menu selection**

The safety setting (lock) for menu access can be defined via this menu in order to prevent unauthorized interventions.

Factory settings are marked with "\*"

<b>SECURE</b>	
<ul style="list-style-type: none"> <li>— S.APPLI <ul style="list-style-type: none"> <li>— OFF</li> <li>— ON</li> </ul> </li> <li>— S.UNIT <ul style="list-style-type: none"> <li>— OFF</li> <li>— ON</li> </ul> </li> <li>— S.OP.FUN <ul style="list-style-type: none"> <li>— OFF</li> <li>— ON</li> </ul> </li> <li>— S.METRO <ul style="list-style-type: none"> <li>— OFF</li> <li>— ON</li> </ul> </li> <li>— S.PRINT <ul style="list-style-type: none"> <li>— OFF</li> <li>— ON</li> </ul> </li> <li>— S.PR.COM <ul style="list-style-type: none"> <li>— OFF</li> <li>— ON</li> </ul> </li> <li>— S.PC.OUT <ul style="list-style-type: none"> <li>— OFF</li> <li>— ON</li> </ul> </li> <li>— S.PC.COM <ul style="list-style-type: none"> <li>— OFF</li> <li>— ON</li> </ul> </li> <li>— S.CAL.AD <ul style="list-style-type: none"> <li>— OFF</li> <li>— ON</li> </ul> </li> <li>— RESET <ul style="list-style-type: none"> <li>— OFF</li> <li>— ON</li> </ul> </li> <li>— END</li> </ul>	<p>Application menu</p> <p>Unlock*</p> <p>Locked</p> <p>Unit menu</p> <p>Unlock*</p> <p>Locked</p> <p>Operating functions menu</p> <p>Unlock*</p> <p>Locked</p> <p>Metrology menu</p> <p>Unlock*</p> <p>Locked</p> <p>Printer output menu</p> <p>Unlock*</p> <p>Locked</p> <p>Printer communication menu</p> <p>Unlock*</p> <p>Locked</p> <p>PC output menu</p> <p>Unlock*</p> <p>Locked</p> <p>PC communication menu</p> <p>Unlock*</p> <p>Locked</p> <p>Calibration/adjustment menu</p> <p>Unlock*</p> <p>Locked</p> <p>Restore factory setting of the current menu</p> <p>Unlock*</p> <p>Locked</p> <p>Exit menu level</p>

## 5.4 Calibration and adjustment

The scale can be calibrated and adjusted in this menu.

### Initial calibration

If the scale is being put into operation for the first time, calibration is recommended in order to ensure precise weighing results. Before the calibration, ensure that the appropriate calibration weights are available.

Adjust the GEO setting according to the location (see Table 5.4.4).

### CAL.ADJ

<ul style="list-style-type: none"> <li>— CAL</li> <li>— LIN</li> <li>— GEO</li> <li>— END</li> </ul>	<p>Initiates a two-point calibration (zero and max. load)</p> <p>Initiates a linearization (zero, half weighing range and max. load)</p> <p>The adjustment of the calibration based on the current location is carried out using the geographic adjustment factor (GEO). (Settings from 0 ... 31, default value = 12)</p> <p>Exit menu level</p>
--	--

### 5.4.1 [CAL] calibration

Call up the menu mode:

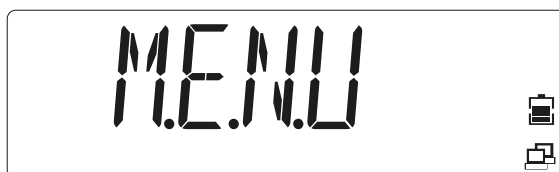

1. Press and hold  until [M.E.N.U] is displayed.





Release the key.

- ▷ The first menu item [APPLIC] (application) is displayed.

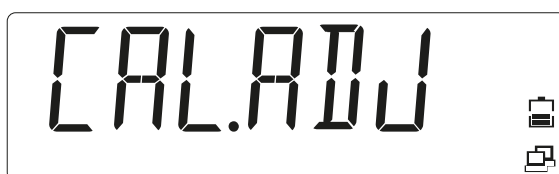

2. Press the  key in order to go to the next menu item, or press the  key to go to the previous menu item.
3. Change the menu item until [CAL.ADJ] is displayed.



4. Press the  (Yes) key to go to the sub-menu item.
  - ▷ The sub-menu item [CAL] (calibration) is displayed.



5. Press the  (Yes) key to start a calibration.
  - ▷ [0 kg] is shown. [0] flashes.



6. Empty the load plate.

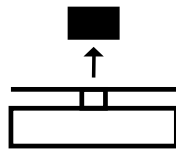

7. Press the  (Yes) key to start the zero point adjustment.
  - ▷ [--C--] is displayed while the zero value is being saved.

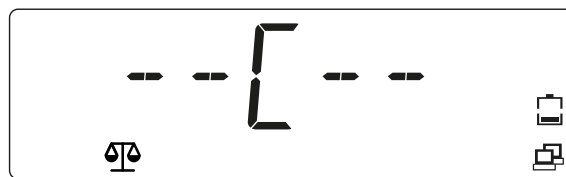

The value of the calibration weight is shown in the display; all digits ([001500.0]) flash (in this example 1,500 kg)

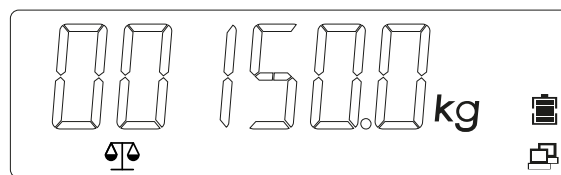



8. To change the value of the calibration weight, press the  (No) key and change the value.
  - ▷ The first digit flashes: [\_0]15.000 kg].



9. Press the  (Yes) key in order to confirm the value and to go to the next digit.
  - ▷ The second digit flashes: [0\_]15.000 kg].



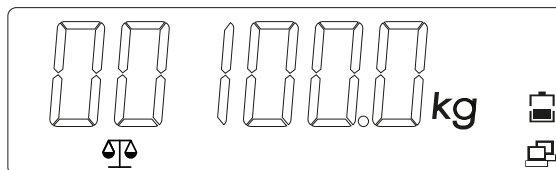

10. Press the  key to increase the value, or the  key to decrease the value.  
 11. Repeat until all digits are correct.

- ▷ The value of the calibration weight is displayed using flashing digits in the display: [00100.0] (in this example 100.0 kg)

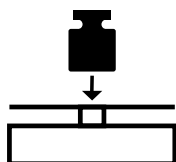

12. If the value of the calibration weight is correct, place the specified weight on the load plate.



13. Press the  (Yes) key to adopt the second calibration point.  
 ▷ [--C--] is displayed while the calibration weight is being saved.

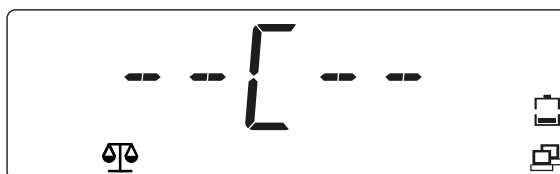

In the event of an error during the calibration process, [CALE] (calibration error) is displayed and the process is canceled.



14. Remove the weight.  
 ▷ The scale is ready for operation.



### 5.4.2 [LIN] linearization

Call up the menu mode:

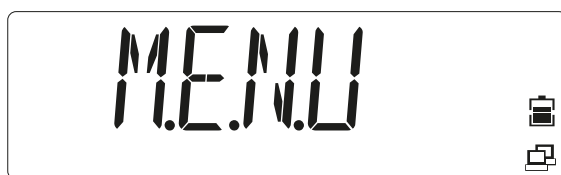

1. Press and hold  until [M.E.N.U] is displayed.





Release the key.

- ▷ The first menu item [APPLIC] (application) is shown in the display.

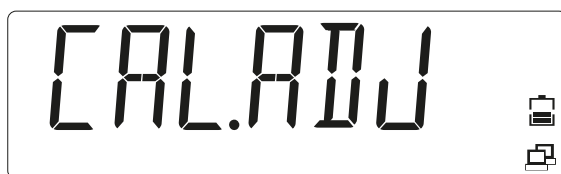

2. Press the  key in order to access the next menu item, or press the  key to access the previous menu item.
3. Repeat until [CAL.ADJ] is shown in the display.



4. Press the  (Yes) key to access the sub-menu item.
5. Select until [LIN] is shown in the display.

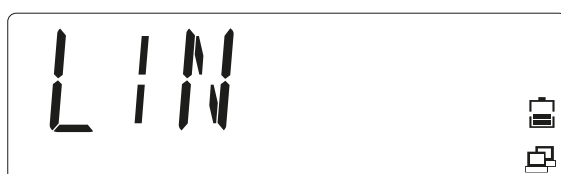

6. Press the  (Yes) key to start the linearization.
 

▷ [0 kg] is shown in the display. [0] flashes.



7. Empty the load plate.

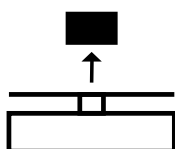

8. Press the  (Yes) key to confirm that no load has been applied.

▷ [--C--] is displayed while the zero value is being saved.

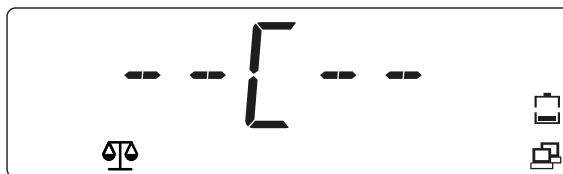

In the display, the value of the 1<sup>st</sup> linearization weight (50% of the capacity of the scale) is displayed with flashing digits [00075.0] (in this example 75 kg). This value cannot be changed.

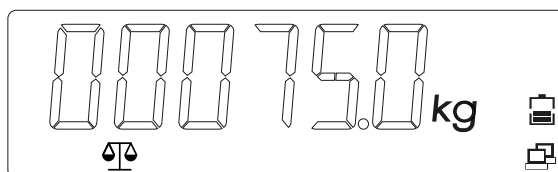

9. Place the 1<sup>st</sup> linearization weight on the load plate.

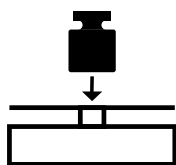

10. Press the  (Yes) key to start the linearization at 50% of the capacity of the scale.

▷ [--C--] is displayed while the value is being saved.



In the display, the value of the 2<sup>nd</sup> linearization weight at 100% of the capacity of the scale is displayed with flashing digits [00150.0] (in this example 150 kg).

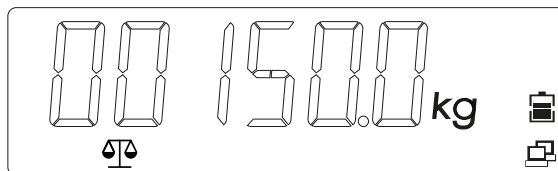

11. Place the 2<sup>st</sup> linearization weight on the load plate.

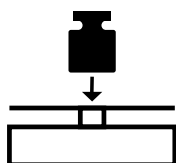

12. Press the  (Yes) key to start the linearization at . 100% of the capacity of the scale.

- ▷ [--C--] is displayed while the value is being saved.



In the display, the value of the linearization weight at 100% of the capacity of the scale is displayed [00150.0] (in this example 150 kg).



If an error occurs during the linearization, [CALE] (calibration error) is displayed and the process is canceled.



13. Remove the weight.
  - ▷ The scale is ready for operation.



### 5.4.3 [GEO] geographic data (calibration location)

The adjustment of the calibration based on the current location is carried out using the geographic adjustment factor [GEO]. (Settings from 0 ... 31 are available.) The table under [5.4.4](#) contains the GEO values for a wide range of latitudes.

Call up the menu mode:

1. Press and hold  until [M.E.N.U] (menu) is displayed.

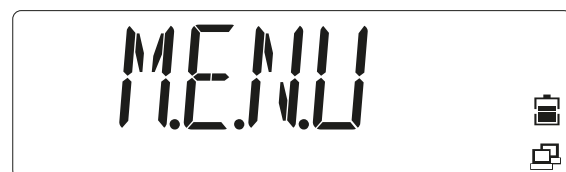



Release the key.



- ▷ The first menu item [APPLIC] (application) is shown in the display.



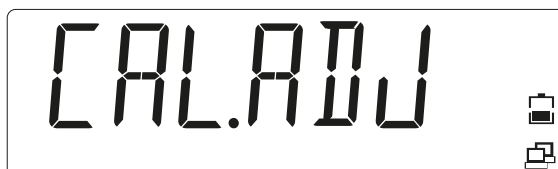

2. Press the  key in order to access the next menu item, or press the  key to access the previous menu item.
3. Repeat until [CAL.ADJ] is shown in the display.





4. Press the  (Yes) key to access the sub-menu item.
5. Press the  key in order to access the next menu item, or press the  key to access the previous menu item.
6. Change the menu item until [GEO] (Geo selection) is displayed.





7. Press the  (Yes) key to start the GEO selection.
  - ▷ The GEO value [12] set by default flashes in the display.



8. If the value needs to be changed, select a value between 0 ... 31 and press the  key to increase the GEO value, or press the  key to decrease the GEO value.
9. Press the  (Yes) key to confirm the GEO value.
  - ▷ The GEO value has been saved when [END] is displayed.



10. Press the  (Yes) key to access the options of the sub-menu.
11. Press the  (No) key to return to the first item in the current menu.
12. Press the  key to exit the settings menu and return to the Weighing application.

**5.4.4 GEO code table**

		Altitude in meters										
		0	325	650	975	1,300	1,625	1,950	2,275	2,600	2,925	3,250
		325	650	975	1,300	1,625	1,950	2,275	2,600	2,925	3,250	3,575
		Altitude in feet										
		0	1,016	2,130	3,200	4,260	5,330	6,400	7,460	8,530	9,600	10,660
		1,060	2,130	3,200	4,260	5,330	6,400	7,460	8,530	9,600	10,660	11,730
Latitude		GEO value										
0°00'	5°46'	5	4	4	3	3	2	2	1	1	0	0
5°46'	9°52'	5	5	4	4	3	3	2	2	1	1	0
9°52'	12°44'	6	5	5	4	4	3	3	2	2	1	1
12°44'	15°06'	6	6	5	5	4	4	3	3	2	2	1
15°06'	17°10'	7	6	6	5	5	4	4	3	3	2	2
17°10'	19°02'	7	7	6	6	5	5	4	4	3	3	2
19°02'	20°45'	8	7	7	6	6	5	5	4	4	3	3
20°45'	22°22'	8	8	7	7	6	6	5	5	4	4	3
22°22'	23°54'	9	8	8	7	7	6	6	5	5	4	4
23°54'	25°21'	9	9	8	8	7	7	6	6	5	5	4
25°21'	26°45'	10	9	9	8	8	7	7	6	6	5	5
26°45'	28°06'	10	10	9	9	8	8	7	7	6	6	5
28°06'	29°25'	11	10	10	9	9	8	8	7	7	6	6
29°25'	30°41'	11	11	10	10	9	9	8	8	7	7	6
30°41'	31°56'	12	11	11	10	10	9	9	8	8	7	7
31°56'	33°09'	12	12	11	11	10	10	9	9	8	8	7
33°09'	34°21'	13	12	12	11	11	10	10	9	9	8	8
34°21'	35°31'	13	13	12	12	11	11	10	10	9	9	8
35°31'	36°41'	14	13	13	12	12	11	11	10	10	9	9
36°41'	37°50'	14	14	13	13	12	12	11	11	10	10	9
37°50'	38°58'	15	14	14	13	13	12	12	11	11	10	10
38°58'	40°05'	15	15	14	14	13	13	12	12	11	11	10
40°05'	41°12'	16	15	15	14	14	13	13	12	12	11	11
41°12'	42°19'	16	16	15	15	14	14	13	13	12	12	11
42°19'	43°26'	17	16	16	15	15	14	14	13	13	12	12
43°26'	44°32'	17	17	16	16	15	15	14	14	13	13	12
44°32'	45°38'	18	17	17	16	16	15	15	14	14	13	13
45°38'	46°45'	18	18	17	17	16	16	15	15	14	14	13

		Altitude in meters										
		0	325	650	975	1,300	1,625	1,950	2,275	2,600	2,925	3,250
		325	650	975	1,300	1,625	1,950	2,275	2,600	2,925	3,250	3,575
		Altitude in feet										
		0	1,016	2,130	3,200	4,260	5,330	6,400	7,460	8,530	9,600	10,660
		1,060	2,130	3,200	4,260	5,330	6,400	7,460	8,530	9,600	10,660	11,730
Latitude		GEO value										
46°45'	47°51'	19	18	18	17	17	16	16	15	15	14	14
47°51'	48°58'	19	19	18	18	17	17	16	16	15	15	14
48°58'	50°16'	20	19	19	18	18	17	17	16	16	15	15
50°16'	51°13'	20	20	19	19	18	18	17	17	16	16	15
51°13'	52°22'	21	20	20	19	19	18	18	17	17	16	16
52°22'	53°31'	21	21	20	20	19	19	18	18	17	17	16
53°31'	54°41'	22	21	21	20	20	19	19	18	18	17	17
54°41'	55°52'	22	22	21	21	20	20	19	19	18	18	17
55°52'	57°04'	23	22	22	21	21	20	20	19	19	18	18
57°04'	58°17'	23	23	22	22	21	21	20	20	19	19	18
58°17'	59°32'	24	23	23	22	22	21	21	20	20	19	19
58°17'	59°32'	24	23	23	22	22	21	21	20	20	19	19
60°49'	62°90'	25	24	24	23	23	22	22	21	21	20	20
62°90'	63°30'	25	25	24	24	23	23	22	22	21	21	20
63°30'	64°55'	26	25	25	24	24	23	23	22	22	21	21
64°55'	66°24'	26	26	25	25	24	24	23	23	22	22	21
66°24'	67°57'	27	26	26	25	25	24	24	23	23	22	22
67°57'	69°35'	27	27	26	26	25	25	24	24	23	23	22
69°35'	71°21'	28	27	27	26	26	25	25	24	24	23	23
71°21'	73°16'	28	28	27	27	26	26	25	25	24	24	23
73°16'	75°24'	29	28	28	27	27	26	26	25	25	24	24
75°24'	77°55'	29	29	28	28	27	27	26	26	25	25	24
77°55'	80°56'	30	29	29	28	28	27	27	26	26	25	25
80°56'	85°45'	30	30	29	29	28	28	27	27	26	26	25
85°45'	90°00'	31	30	30	29	29	28	28	27	27	26	26

## 5.5 SBI interface

A computer connected via the PC interface (SBI communication) can send control commands to the analysis device in order to control the scale or application functions.

All commands have a shared frame format (data input format). They start with the characters ESC and end with the command end EOC (end of command). The end of command may also be a combination of CR and LF. The scale ignores all entries after EOC and before ESC.

#### Reading the displayed value:

ESC	P	EOC
-----	---	-----

Response (16 bytes):

V	W	W	W	W	W	W	W	W	W	W	E	E	E	CR	LF
---	---	---	---	---	---	---	---	---	---	---	---	---	---	----	----

V	Algebraic sign	Possible characters: "+", "-", ""
W	Weight value	Possible characters: "0"... "9", ".", "", ""
E	Unit	Possible characters: "a"... "z", "A"... "Z", ""
CR	Carriage return	ASCII 0x0D
LF	Line feed	ASCII 0x0A

This format is also used for automatically generated telegrams, which are released according to the menu settings: [INT.OUT], [AUT.OUT], [AUT.STA] (see above).

#### Zeroing the scale:

ESC	Z	EOC
-----	---	-----

Response: see special response telegrams

#### Taring the scale:

ESC	T	EOC
-----	---	-----

Response: see special response telegrams

#### Special response telegrams:

There are some special responses, which are used as standard responses. Example: Error or confirmation. Special response telegrams are always 5 bytes.

#### OK (confirmed)

1	2	3	4	5
O	K	!	CR	LF

The scale confirms error-free performance of the command.

**ERROR** (error)

---

1	2	3	4	5
E	R	R	CR	LF

---

The scale reports an error when performing the command.

**LOCKED** (locked)

---

1	2	3	4	5
L	O	C	CR	LF

---

The command cannot be performed because a parameter is currently blocked.

## 6 Maintenance/repairs/cleaning

### 6.1 Repairs

Disconnect a defective device from the mains immediately.

Defective or damaged cables or screw connections must be replaced as a complete unit.

#### **WARNING**

**Improper repairs can pose considerable risks to the user.**

- ▶ Only have repairs carried out by Minebea Intec qualified dealers using original spare parts.

### 6.2 Cleaning

#### 6.2.1 Instructions for cleaning

The device must be cleaned of contaminants on a regular basis.

Before cleaning, maintenance, or repairs, disconnect the device from the supply voltage.

If the scale is in a dry environment, wipe the weighing platform with a damp cloth.

Household cleaning agents can be used. Please check the information provided by the manufacturer.

Devices with protection grade IP65 or above may also be rinsed with a water jet directed onto the load plate from above.

In the case of devices with an IP43 protection grade, no liquid must get into the scale.

If the device is cleaned with water that is too hot or too cold due to temperature differences, condensation may form in the device. Condensation may cause malfunctions in the device.

#### 6.2.2 Cleaning agents

#### **NOTICE**

**Some cleaning agents may not be compatible with the device material.**

- ▶ Only use disinfectants and cleaning agents in line with the manufacturer's instructions.
- ▶ Do not use cleaning agents that are very acidic, very alkaline, or that contain a high level of chlorine. Avoid substances with a high or low pH value as otherwise there is an increased risk of corrosion.
- ▶ Do not use any abrasive sponges containing iron, steel brushes, or cleaning sponges made of steel wool.
- ▶ Always test cleaning agents and materials in non-critical areas first before using them.

## 7 Waste disposal policy

If the packaging is no longer required, please take it to your local waste disposal facility and/or a reputable disposal company or collection point. The packaging largely consists of environmentally friendly materials, which are suitable for recycling.

It is not permitted—even for small businesses—to dispose of this product with the regular household waste or at collection points run by local public waste disposal companies.

EU legislation requires its Member States to collect electrical and electronic equipment and dispose of it separately from other unsorted municipal waste so that it can then be recycled.

Before disposing of or scrapping the product, any batteries should be removed and taken to a suitable collection point.

Please see our T&Cs for further information.

We reserve the right not to accept products that have been contaminated with hazardous substances (ABC contamination) for repair.

## 8 Error correction

### 8.1 Service information

Contact the authorized service partners if a problem cannot be rectified with the aid of the troubleshooting information or is not described there. Our website <http://www.purocales.com> provides information about your closest service partner.



## 9 Technical data

### 9.1 Specification

<b>Model number</b>	<b>EF-4P</b>	<b>1,500</b>	<b>3,000</b>
Max. load (kg)		1,500	3,000
Readability d (kg)		0.5	1
Max. resolution		3,000	3,000
Dimensions in mm (W x D x H)	LL	1,000 x 1,000 x 110	
	NN	1,250 x 1,250 x 110	1,250 x 1,250 x 110
	RR	1,500 x 1,500 x 110	1,500 x 1,500 x 110
Applications	4	Weighing, Counting, Check Weighing, Check Counting, Totalizing	
Version/materials indicator	P	Plastic	
Version/materials platform	P	Frame made of painted carbon steel, load plate made of stainless steel 304, 1.2 mm	
	S	Entirely made of stainless steel 304	
<b>Indicator</b>			
Weight units		kg, g, lb, oz, lb:oz	
Protection grade		IP43	
Display		LCD display with white background lighting, digit height 0.8 inches/20 mm	
Indicator displays		3 LEDs (yellow, green, red), function can be configured, acoustic alarm signal	
Keypad		5 mechanical keys	
Zero range		2 or 10% of the max. load of the scale	
Tare range		Max. load via subtraction	
Stabilization time		1 second	
Automatic zero point correction		Off, increments of 0.5, 1, or 3	
Electrical supply		Power supply (100–240 V, ~50/60 Hz) or installed, rechargeable lithium battery	
Battery operation time		Up to 200 hours operation time (with standard battery) between the charging processes, 12 hours charge time	
Calibration		External with calibration weights	
Interface		USB-C, printer port, RS-232, LC installed	
<b>Platform</b>			
Safe overload range (central load)		150% of the max. load of the scale	

<b>Model number</b>	<b>EF-4P</b>	<b>1,500</b>	<b>3,000</b>
Safe overload range (corner load)	50% of the max. load of the scale		
Safe overload range (side load)	100% of the max. load of the scale		
Leveling aids	Externally visible level indicator and adjustable leveling feet		
Protection grade of the load cell(s)	IP67		
Excitation voltage of the load cell(s)	max. 18 V (AC/DC)/5 V–12 V (AC/DC) recommended		
Net weight (kg)	LL	78	
	NN	82	
	RR	142	
Shipping dimensions in mm (W x D x H)	LL	1,080 x 1,080 x 255	
	NN	1,330 x 1,330 x 255	
	RR	1,580 x 1,580 x 255	
Shipping weight (kg)	LL	90	
	NN	130	
	RR	250	

## 9.2 Accessories

<b>Option</b>	<b>Order no.</b>
Lithium battery pack:	
Battery pack, small compact scale 4 cells standard capacity	YP-BPS4S
Battery pack, large compact scale 6 cells standard capacity	YP-BPL6S
Data printer:	
Brightek WHT2BR10	YP-DP1

### 9.3 Dimensions

#### EF-4P

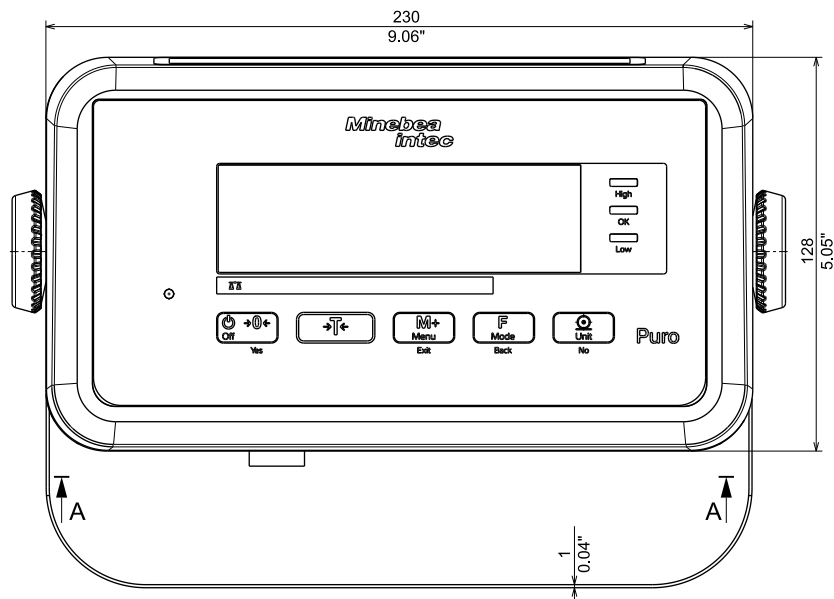
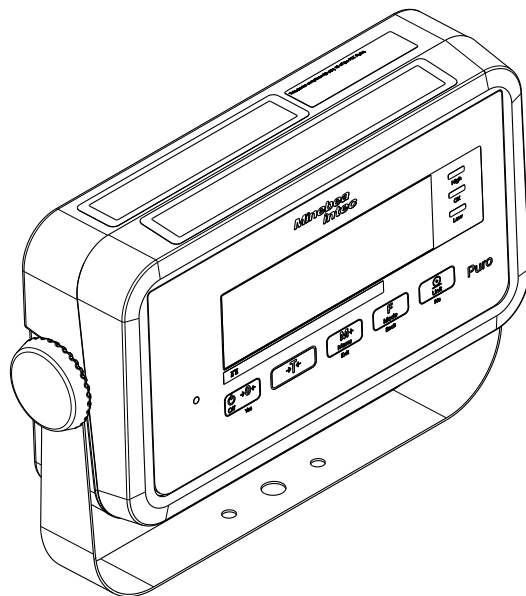

All dimensions in mm / inch

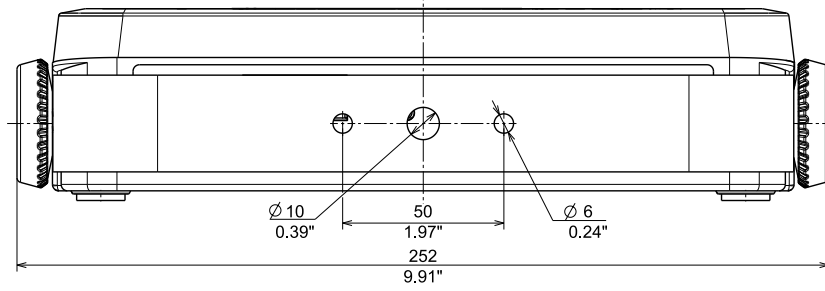

All dimensions in mm / inch

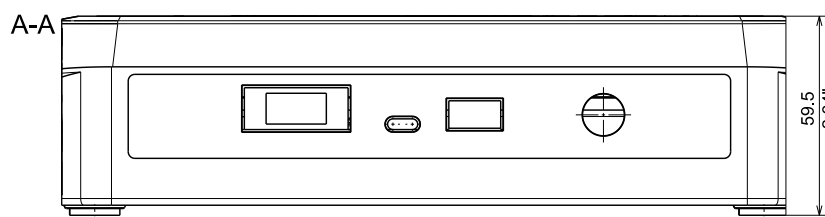

All dimensions in mm / inch

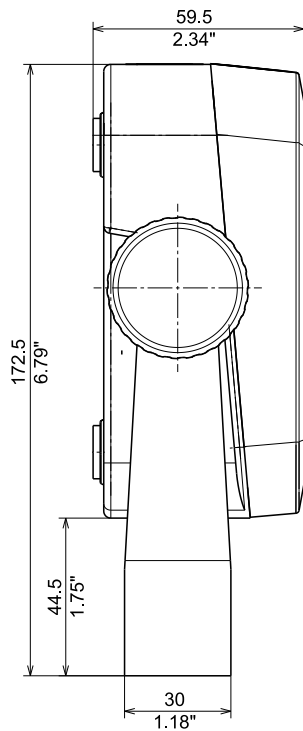

All dimensions in mm / inch

**EF-4PLLP-1500**

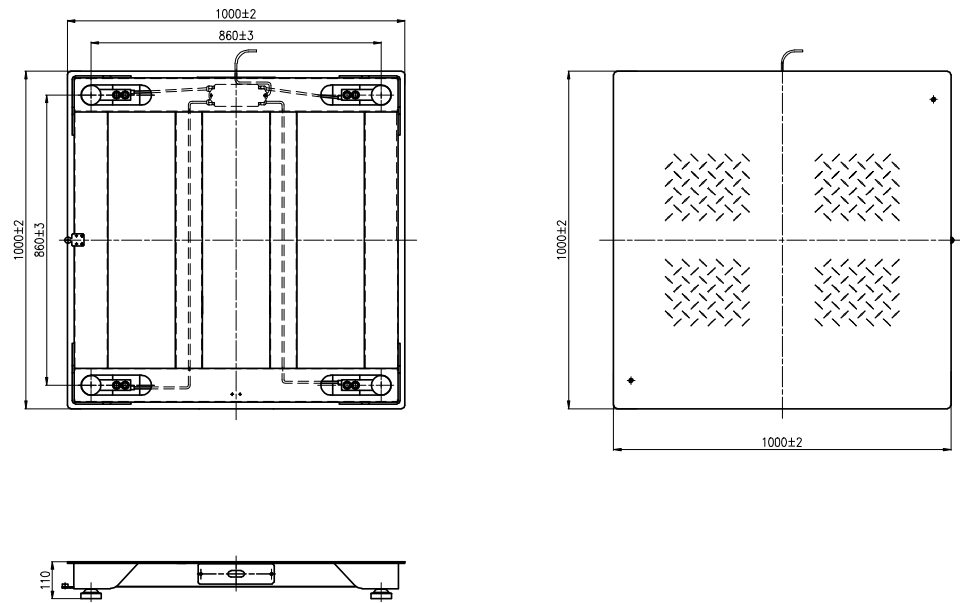

All dimensions in mm

**EF-4PLLS-1500**

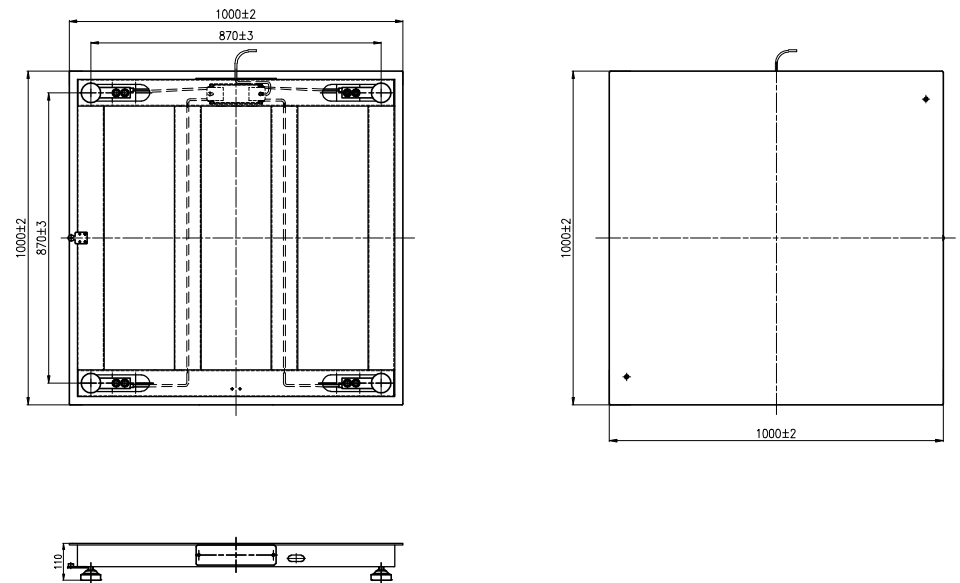

All dimensions in mm

**EF-4PNNP-1500/3000**

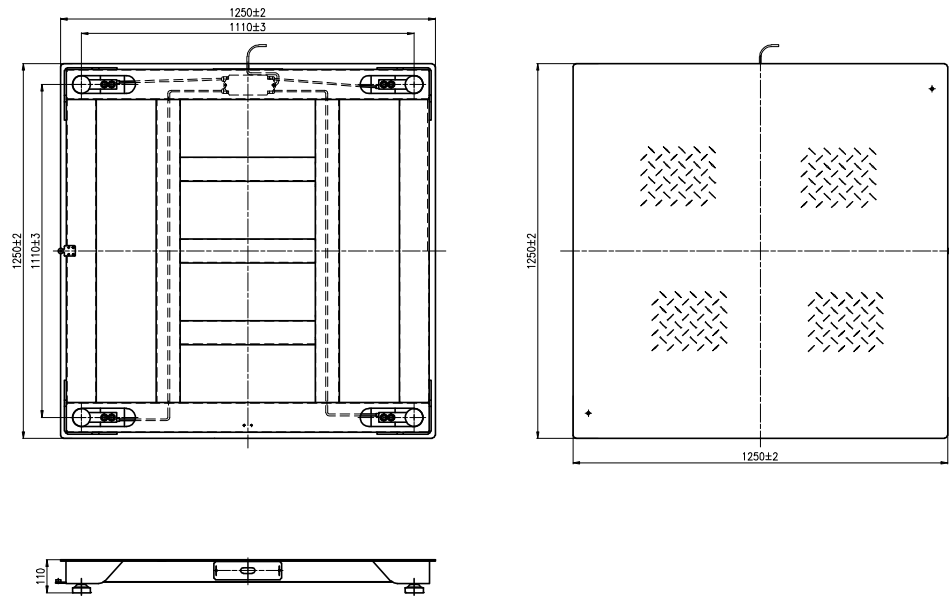

All dimensions in mm

**EF-4PNNS-1500/3000**

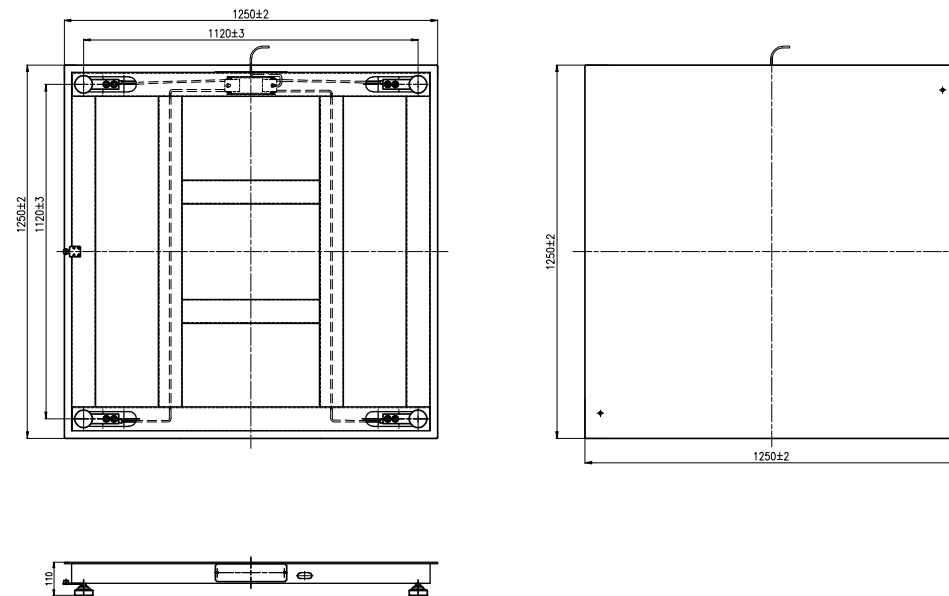

All dimensions in mm

**EF-4PRRP-1500/3000**

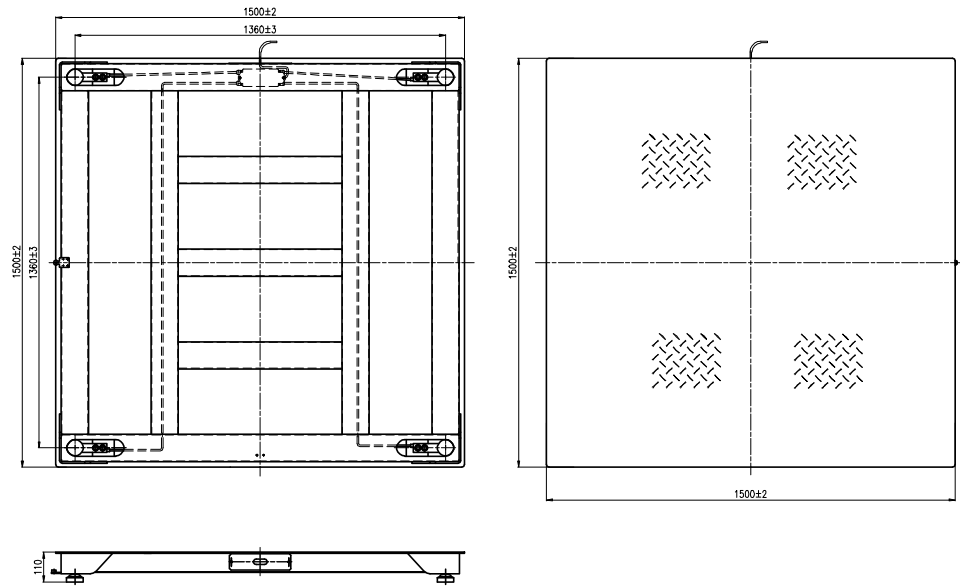

All dimensions in mm

**EF-4PRRS-1500/3000**

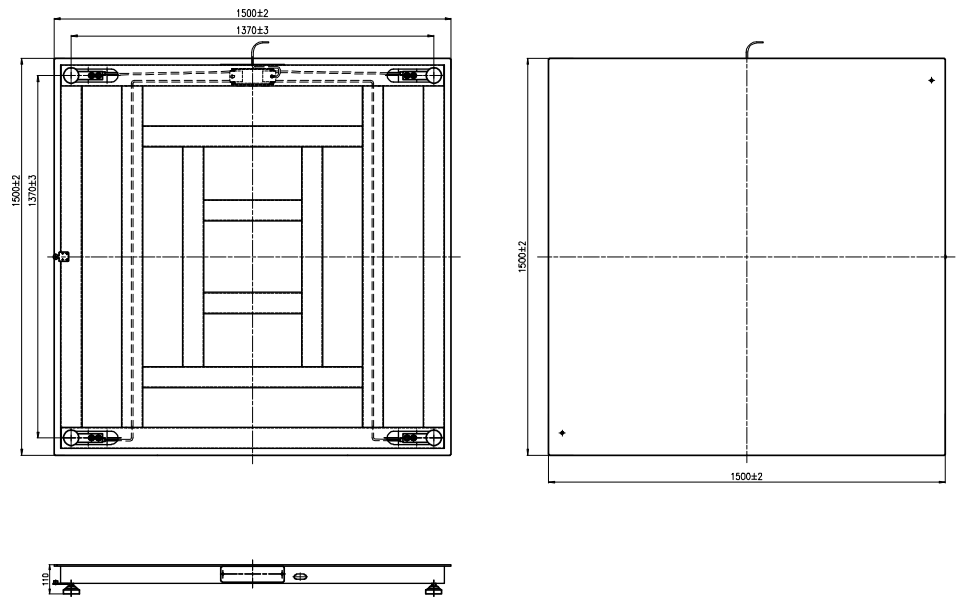

All dimensions in mm

## 10 Appendix

### 10.1 Printouts

Printouts can be created by pressing the  key or using the control command "P". The settings for printouts can be changed in the menu (see Chapter [5.3.2.5](#)).

Example printouts:

#### Printout for the Weighing application

			Description	Note
11.11	kg	N	Result line	If Printx → Content → Result = ON
1.23	kg	T	Tare value line	If Printx → Content → Tare = ON
11.11	kg	N	Net value line	If Printx → Content → Net = ON
12.34	kg	G	Gross value line	If Printx → Content → Gross = ON
MODE: WEIGHT			Mode line	If Printx → Content → Application mode = ON
<no line printed>			Information line	If Printx → Content → Info = ON

#### Printout for the Weighing application with Totalizing application

			Description	Note
11.11	kg	N	Result line	If Printx → Content → Result = ON
1.23	kg	T	Tare value line	If Printx → Content → Tare = ON
11.11	kg	N	Net value line	If Printx → Content → Net = ON
12.34	kg	G	Gross value line	If Printx → Content → Gross = ON
MODE: WEIGHT			Mode line	If Printx → Content → Application mode = ON
N: 4			Total line	If Printx → Content → Total = All
TOTAL: 50.35 kg			Total line	If Printx → Content → Total = All or Result
MIN: 11.11 kg			Total line	If Printx → Content → Total = All
MAX: 14.85 kg			Total line	If Printx → Content → Total = All

### 10.2 FCC notice

#### Note:

This device has been tested and found to comply with the limits for digital devices of class B as per part 15 of the FCC regulations. These limits were created in order to ensure appropriate protection against interference when operating in residential areas. This device generates, uses, and may emit high-frequency energy and, if it is not installed and used in accordance with the operating instructions, may cause interference with radio communication. However, there is no guarantee that interference will not occur in certain facilities. If this device causes interference with the radio or television reception, which can be determined by switching the device off and then back on again, we recommend one or more of the following measures to eliminate the interference:

- Realignment or repositioning of the reception antenna
- Increasing the distance between the device and the receiver
- Connecting the device and the receiver to separate electric circuits
- Call in the dealer or an experienced radio/television technician



Published by  
Minebea Intec Bovenden GmbH & Co. KG | Leinetal 2 | 37120 Bovenden, Germany  
Phone: +49.551.309.83.0 | Email: [info@minebea-intec.com](mailto:info@minebea-intec.com)  
[www.minebea-intec.com](http://www.minebea-intec.com)

