

Operating Instructions
Original Operating Instructions

Moisture Analyzer

Model MA35
Electronic Moisture Analyzer



1000034789



SARTORIUS

Contents

Intended Use	4
Warnings and Safety Information	5
Getting Started	8
General View of the Equipment	8
Storage and Shipping Conditions	9
Conditioning the Moisture Analyzer	10
Setting up the Moisture Analyzer	10
Connecting the Moisture Analyzer to AC Power	11
Safety Precautions	11
Connecting Electronic Peripheral Devices	11
Warmup Time	12
Leveling the Moisture Analyzer	12
Installing the Aluminum Panels (Optional; Part No. YDS05MA)	12
Turning On the Analyzer; Opening and Closing the Sample Chamber	13
Basic Principles	14
Purpose	14
Material	14
Preparation	17
Adjusting against an Existing Measurement System	17
Setting the Drying Program Parameters	17
Preparing the Sample	17
Use a disposable sample pan	18
Distribute the sample on the sample pan	18
Operating Design	19
Keys	19
Display	20
Configuration	21
Setting the Device Parameters	21
Setting the Drying Parameters	23
Operation	27
Example: Analysis with Specified Drying Time	27
Adjusting the Analyzer	29
Heating Element Adjustment	29
Weighing System Adjustment	29
External Calibration and Adjustment with a Factory-Defined Weight	30
Interface Port	32
Female Interface Connector	33
Error Codes	34
Care and Maintenance	35
Service	35
Repairs	35
Cleaning	35
Cleaning the Heating Unit and Temperature Sensor	36
Safety Inspection	37
Disposal	37
Service Address for Disposal	37
Overview	38
Specifications	38
Accessories (Options)	40
EU Declaration of Conformity	41
FCC Supplier's Declaration of Conformity	42
CSA Certificate of Compliance	43

Intended Use

The MA35 moisture analyzer is intended for fast and reliable determination of the material moisture content of liquid, pasty and solid substances using the thermogravimetric method.

Symbols

The following symbols are used in these instructions:

- indicates steps you must perform
- indicates steps required only under certain conditions
- > describes what happens after you have performed a particular step
- indicates an item in a list
-  indicates a hazard

Warnings and Safety Information

This moisture analyzer complies with the European Council Directives as well as international regulations and standards for electrical equipment, electromagnetic compatibility, and the stipulated safety requirements. Improper use or handling, however, can result in damage and/or injury.

To prevent damage to the equipment, read these operating instructions thoroughly before using your MA35 moisture analyzer. Keep these instructions in a safe place.

Follow the instructions below to ensure safe and trouble-free operation of your moisture analyzer:

 Use the moisture analyzer only for performing moisture analysis on samples. Any improper use of the analyzer can endanger persons and may result in damage to the analyzer or other material assets.

 Do not use this moisture analyzer in a hazardous area; operate it only under the ambient conditions specified in these instructions.

 If you use electrical equipment in installations and under ambient conditions subject to stricter safety standards than those described in the manual, you must comply with the provisions as specified in the applicable regulations for installation in your country.

- The moisture analyzer may be operated only by qualified persons who are familiar with the properties of the sample to be analyzed.

 Make sure before getting started that the voltage rating printed on the manufacturer's label is identical to your local line voltage (see "Connecting the Moisture Analyzer to AC Power" in the chapter entitled "Getting Started").

- The analyzer comes with a power supply that has a grounding conductor.
- The only way to switch the power off completely is to unplug the power cord.
- Position the power cord so that it cannot touch any hot areas of the moisture analyzer.
- Use only extension cords that meet the applicable standards and have a protective grounding conductor.
- Disconnecting the ground conductor is prohibited.
- Connect only Sartorius accessories and options, as these are optimally designed for use with your moisture analyzer.

Note on installation:

The operator shall be responsible for any modifications to Sartorius equipment or connections of cables not supplied by Sartorius and must check and, if necessary, correct these modifications. On request, Sartorius will provide information on the minimum operating specifications.

- Protect the analyzer from contact with liquid
- If there is visible damage to the equipment or power cord, unplug the equipment and lock it in a secure place to ensure that it cannot be used for the time being.

 Clean your moisture analyzer only according to the cleaning instructions (see "Care and Maintenance").

Do not open the analyzer housing.

- Please contact your local Sartorius Service should any problems arise with your device.



Warning: Severe Burns!

- When setting up the moisture analyzer, leave enough space to prevent heat from building up and to keep your analyzer from overheating:
 - leave 20 cm (about 8 inches) around the moisture analyzer
 - leave 1 m (3 ft.) above the moisture analyzer
- Do not place any flammable substances on, under or near the moisture analyzer, because the area around the heating unit will heat up
- Be careful when removing a sample from the chamber: the sample, the heating unit and the sample pan may still be extremely hot
- Prevent excess heat build-up around the analyzer

Hazards for persons or equipment posed by certain sample materials:



Fire



Explosion

- Flammable or explosive substances
- Substances that contain solvents
- Substances that release flammable or explosive gases or vapors during the drying process

In some cases, it is possible to operate the moisture analyzer in an enclosed nitrogen atmosphere to prevent the vapor released during drying from coming into contact with oxygen in the surrounding atmosphere. Check on a case-to-case basis whether this method can be used, because installation of the analyzer in too small an enclosed space can affect its functioning (for instance, through excessive heat build-up within the analyzer). When in doubt, perform a risk analysis.

The user shall be liable and responsible for any damage that arises in connection with this moisture analyzer.



Poisoning



Caustic burns

- Substances containing toxic or caustic or corrosive components may only be dried under a fume hood. The value for the "lower toxic limit" in a work area must not be exceeded.
- Corrosion:
 - Corrosion may be caused by substances that release aggressive vapors during the heating process (such as acids).

We recommend working with only small quantities of such samples, to avoid build-up of vapors that can condense on cold housing parts and can cause corrosion.

The user shall be liable and responsible for any damage that arises in connection with this moisture analyzer.

Getting Started

General View of the Equipment

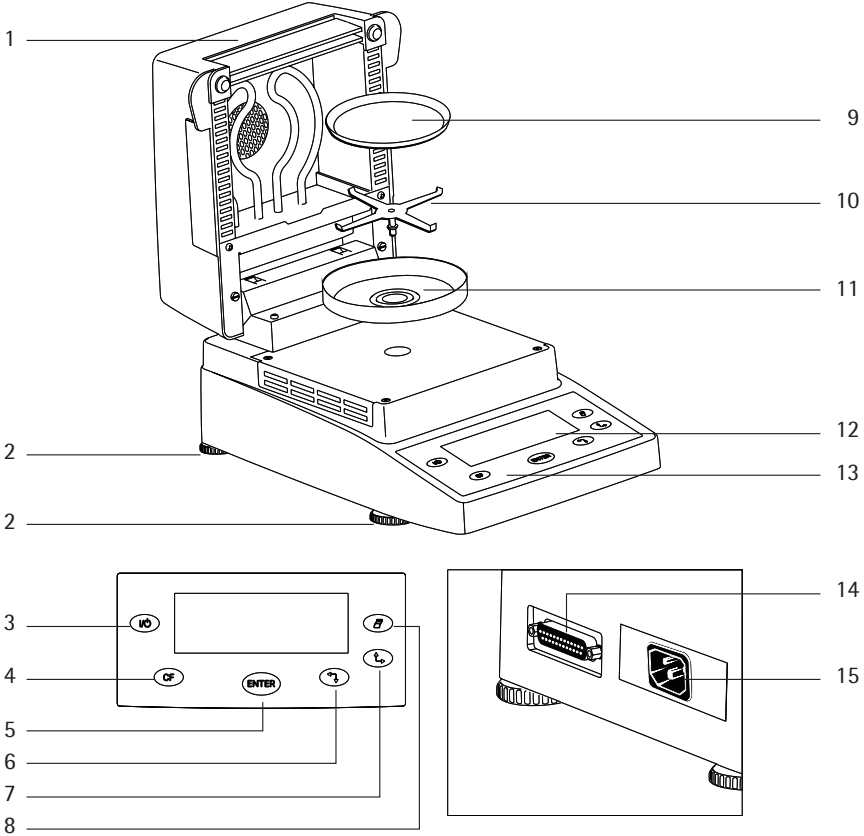

Pos.	Designation
1	Hinged cover with heating element
2	Leveling feet
3	On/off key
4	CF key (clear function; delete)
5	Enter key (confirm)
6	'Down/Back' key
7	'Up/Forward' key
8	Print key

Pos.	Designation
9	Disposable sample pan
10	Pan support
11	Pan draft shield
12	Display
13	Keypad
14	Interface port
15	Power jack

The moisture analyzer is a compact analyzer and comprises the following components: a heater unit, a weighing system and an operating unit. In addition to the socket for AC power (mains supply), it also has an interface port for connecting peripheral devices, such as a computer, printer, etc.

Storage and Shipping Conditions

Allowable storage temperature:
-20 to +70°C

Do not expose the moisture analyzer unnecessarily to extreme temperatures, moisture, shocks, blows or vibration.

Unpacking the Moisture Analyzer

- After unpacking the equipment, please check it immediately for any visible damage
- If any sign of damage is visible, proceed as directed under "Safety Inspection" in the chapter entitled "Care and Maintenance."

It is a good idea to save the box and all parts of the packaging until you have successfully installed your equipment. Only the original packaging provides the best protection for shipment. Before packing your moisture analyzer, unplug all connected cables to prevent damage.

Equipment Supplied

The equipment supplied includes the components listed below:

- Moisture analyzer
- Power cord
- Pan support
- Pan draft shield
- 80 disposable aluminum sample pans
- 1 pair of forceps

Installation Instructions

The MA35 moisture analyzer is designed to provide reliable results under normal ambient conditions in the laboratory and in industry. When choosing a location to set up your analyzer, observe the following so that you will be able to work with added speed and accuracy:

- Set up the moisture analyzer on a stable, even surface that is not exposed to vibrations, and level it using the four leveling feet
- Avoid placing the moisture analyzer in close proximity to a heater or otherwise exposing it to heat or direct sunlight
- Avoid exposing the moisture analyzer to extreme temperature fluctuations
- Protect the moisture analyzer from drafts that come from open windows or doors
- Keep the moisture analyzer protected from dust, whenever possible
- Protect the moisture analyzer from aggressive chemical vapors
- Do not expose the equipment to extreme moisture over long periods
- Make sure to choose a place where excessive heat cannot build up. Leave enough space between the moisture analyzer and materials that are affected by heat.

Conditioning the Moisture Analyzer

Moisture in the air can condense on the surfaces of a cold moisture analyzer whenever it is brought into a substantially warmer place. If you transfer the moisture analyzer to a warmer area, condition it for about 2 hours at room temperature, leaving it unplugged from AC power. Leave the device connected to the power supply after first connecting.

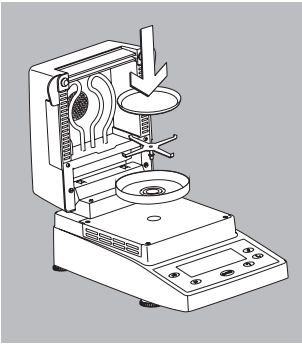

Setting up the Moisture Analyzer

- Position the components listed below in the order given:
 - Pan draft shield
 - Pan support
 - Disposable sample pan

Connecting the Moisture Analyzer to AC Power

- Check the voltage rating and the plug design
- The heating element has been factory-set to 230 V or 115 volts for technical reasons. The voltage has been set as specified on your order. The voltage setting is indicated on the manufacturer's label (see the bottom of the analyzer), for example:
 - 230 volts: MA35M-...230...
 - 115 volts: MA35M-...115...



CAUTION! If the voltage indicated on the label does not match your local line voltage:

Do not operate your moisture analyzer; contact your local Sartorius office or dealer.

Use only

- Genuine Sartorius power cords, or
- Power cords approved by a certified electrician
- If you need to connect an extension cord, use only a cable with a protective grounding conductor

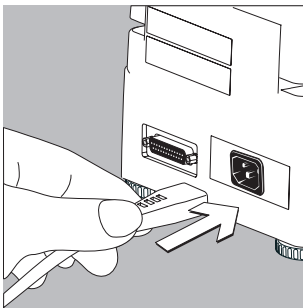

- Connecting the moisture analyzer, rated to Class 1, to AC power (mains supply):
Plug the power cord into an electrical outlet (mains supply) that is properly installed with a protective grounding conductor (protective earth = PE)

Safety Precautions

If you use an electrical outlet that does not have a protective grounding conductor, make sure to have an equivalent protective conductor installed by a certified electrician as specified in the applicable regulations for installation in your country.

Make sure the protective grounding effect is not neutralized by use of an extension cord that lacks a protective grounding conductor.

Connecting Electronic Peripheral Devices

- Make absolutely sure to unplug the analyzer from AC power before you connect or disconnect a peripheral device (printer or PC) to or from the interface port.

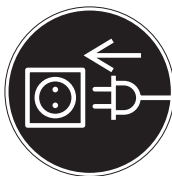

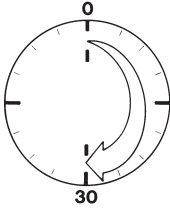

Warmup Time

To deliver exact results, the moisture analyzer must warm up for at least 30 minutes every time you connect it to AC power or after a relatively long power outage.

Only after this time will the analyzer have reached the required operating temperature.

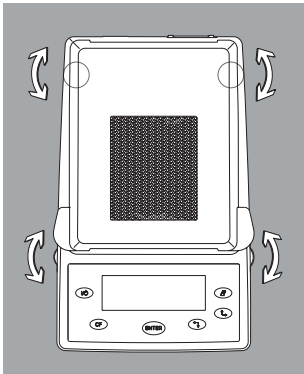

Leveling the Moisture Analyzer

Purpose:

- To compensate for unevenness at the place of installation
- This is particularly important for testing liquid samples, which must be at a uniform level in the sample pan

Always level the moisture analyzer again any time after it has been moved to a different location.

- Extend or retract the front and/or rear leveling feet as needed to adjust the moisture analyzer

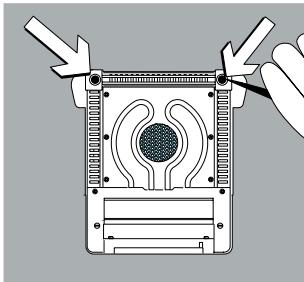

Installing the Aluminum Panels (Optional; Part No. YDS05MA)

⚠ To prevent burns, allow the glass panels to cool sufficiently before removing them

⚠ Do not handle the aluminum panels with oily or greasy fingers

⚠ Do not scratch the aluminum panels; do not use abrasive or corrosive substances to clean the aluminum panels

- Remove the 2 rubber caps and the 2 screws beneath them, and then remove the panel retainer
- Remove the glass panels
- Position the aluminum panels in the retainer
- Fasten the aluminum panels with the retainer and screws; replace the 2 rubber caps

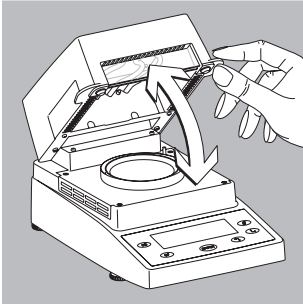

Turning On the Analyzer; Opening and Closing the Sample Chamber

- To turn on the analyzer: press 
- When opening or closing the sample chamber, do not release the cover until it is in the fully open or fully closed position

Basic Principles

Purpose

The moisture analyzer can be used for quick and reliable determination of the moisture content of materials of liquid, pasty, and solid substances using the thermogravimetric method.

Material

The moisture of a material is often mistakenly equated to its water content. In fact, the moisture of a material includes all of the volatile components which are emitted when the sample is heated, irrespective of the type of material. Among such volatile substances are:

- Water
- Fats
- Oils
- Alcohols
- Organic solvents
- Flavorings
- Volatile components, products of decomposition (when a sample is overheated)

There are many methods for determining the moisture content of a substance. Basically, these methods can be divided into two categories:

When absolute methods are used, the moisture content is directly determined (for example, as a weight loss registered during the drying routine). These methods include oven drying, infrared drying, and microwave drying. All three of these methods are thermogravimetric.

When deductive methods are used, the moisture content is indirectly determined. A physical property related to the moisture in the substance is measured (e.g., conductivity). These methods include capacitive and spectroscopic approaches.

Thermogravimetry is the process of determining the loss of mass that occurs when a substance is heated. In this process, the sample is weighed before and after being heated, and the difference between the two weights is calculated.

In a conventional drying oven, circulating hot air warms the sample from the outside to the inside. Efficiency is lost during drying because as the moisture evaporates, it cools the sample surface.

By contrast, infrared rays (IR rays) penetrate the substance. The majority of the rays reach the interior of a sample, and then directly heat the sample.

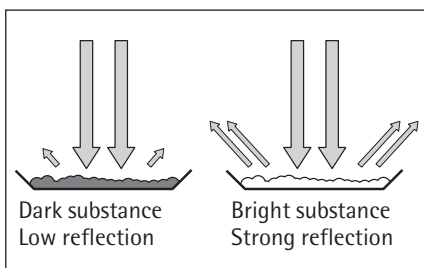
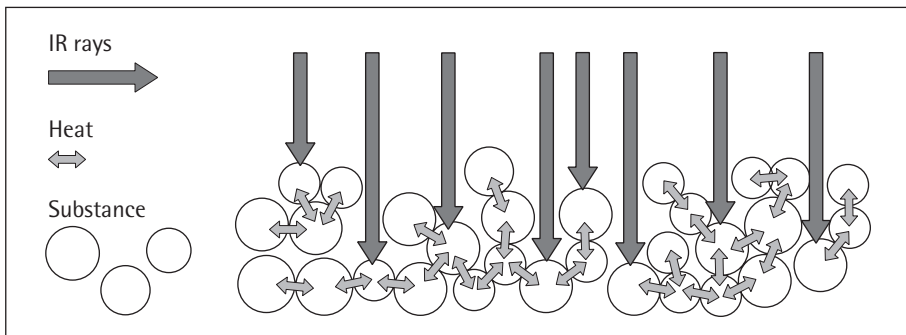

How the rays penetrate the sample depends on the permeability of the sample. If the degree of light-transmitting capacity is low, the rays can penetrate only the uppermost layers of the sample. The heat conductivity of the sample dictates the degree to which the heat can be transmitted to the underlying layers. The higher the conductivity, the faster and more uniformly the substance is heated.

The proportion of the IR rays which does not heat the sample is either reflected on the surface of the sample or penetrates the sample unimpeded.

The color and surface properties of the sample significantly influence how effective the heating process is. For example, dark substances absorb IR rays better than bright substances.

The substance should be applied to the sample pan in a thin, even layer. A height of approximately 2–5 mm for 5–15 g substance weight has proved to be ideal. Otherwise, the sample will not be dried completely or the analysis time will be unnecessarily extended, a crust/skin will form on the surface of the sample or the sample will scorch, and the analysis results obtained will not be reproducible (and hence cannot be used).

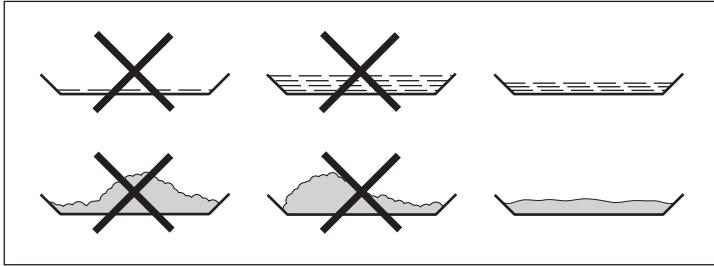

While preparing substances for measurement, no processes may be used that generate heat. The heat generated may result in a loss of moisture prior to the measurement.

Perform initial analysis of a new substance to test how the IR rays are absorbed by the sample and converted into heat. A printout of the intermediate values of the drying process provides information on this at an early stage.

Since introducing IR rays produces intensive energy input in the sample, the temperature setting selected for infrared drying is usually lower than the temperature setting used when working with a drying oven.

In many cases, the fully automatic switch-off mode will meet your requirements. If the final result is higher or lower than expected, try varying the temperature setting before resorting to a different switch-off criterion.

When analyzing the samples that lose their moisture only very slowly or when operating a cold moisture analyzer, the fully automatic mode may end the drying routine too early since no analyzable progress in the drying routine can be detected. In this case, preheat the moisture analyzer for two to three minutes before starting the drying routine, or select a different switch-off criterion.

Preparation

Before drying a sample, you must carry out the following preparations:

- Adjust against the existing measurement system
- Prepare the sample
- Set the drying program parameters

Adjusting against an Existing Measurement System

A moisture analysis method often replaces another drying method (such as oven drying method) because it is simple to use and requires shorter analysis time. In this case, you should adapt this method to that of the moisture analyzer in order to obtain values comparable to those yielded by your standard reference method.

Setting the Drying Program Parameters

- By selecting the right drying program parameters, it is possible to achieve the same results as the standard procedure in a much shorter time and with much simpler operation.

Preparing the Sample

- ▶ Select a sample
Select a representative part of the whole substance as a sample.
- Choose a representative number of individual samples for quality control
- Choose enough samples to indicate a trend for in-process control

If required, homogenize the product before a sample is taken by:

- Mixing or stirring
- Taking several samples from different areas of the product
- Taking several samples at defined intervals

Take only one sample at a time for a given analysis and prepare it as quickly as possible.

In this way, it will not lose or gain moisture as a result of the ambient conditions.

If several samples need to be taken simultaneously, the samples must be sealed in airtight containers to ensure that the storage conditions do not alter the state or condition of the samples:

- Warm or highly volatile substances lose their moisture very quickly.
- If you store the samples in a container, the moisture can condense on the walls of the container.
- If the container is too big and not filled completely, the sample can exchange its moisture with the air remaining in the container.

Mix the condensed moisture back in with a sample if necessary.

Prepare the sample

When crushing a sample, avoid any contact with heat. Heat results in moisture loss.

- ▶ Crush the sample using
 - Pestle
 - Lab mill

-
- ▶ Use an appropriate tool for grinding the sample.
 - ▶ If the sample is liquid containing solids, use one of the following tools:
 - Glass stirrer
 - Spoon
 - Magnetic stirrer

Use a disposable sample pan

- ▶ Use only Sartorius disposable sample pans (inner diameter of 90 mm). Reusing sample pans leads to poor repeatability of results:
 - After cleaning, sample residues can still remain on the pan.
 - Residues from cleaning agents can evaporate during the next moisture analysis.
 - Scratches and grooves made during cleaning result in damage that forms points of attack for hot, rising air produced during the drying process (more pronounced buoyancy).

Distribute the sample on the sample pan

- ▶ Distribute the sample on the sample pan in a thin, even layer (height: 2 to 5 mm, weight: 5 to 15 g); otherwise:
 - A sample applied unevenly will result in a nonuniform distribution of heat
 - The sample will not be dried completely
 - The analysis time will be unnecessarily extended
 - The sample will burn or a crust/skin will form on its surface as a result of a very thick layer
 - The crust makes it difficult or impossible for moisture to escape from the sample during the drying process
 - An uncertain and unknown quantity of moisture will remain in the sample

- ▶ Apply liquid samples, pasty samples, or samples that can melt to a glass-fiber filter (order no. 6906940); this provides the following benefits:
 - Uniform distribution due to the capillary effect
 - Liquids are prevented from beading together and forming drops
 - With larger surfaces, the moisture can evaporate faster
 - Colorless/transparent samples do not reflect
 - Considerably more convenient than the "sea-sand method"

When drying samples containing sugar, a crust or skin can form and seal the surface. A glass-fiber filter is particularly useful in such cases. The moisture can evaporate downwards through the surface of the filter. Crust/skin formation can be prevented or limited by placing the glass-fiber filter on top of the sample.

- ▶ Cover solid, heat-sensitive samples with a glass-fiber filter (order no. 6906940); this provides the following benefits:
 - Gentle heating, because the sample surface is shielded from excessive heat
 - Higher temperature setting can be selected
 - Uniformity of the sample surface
 - Fast evaporation of the moisture
 - Excellent repeatability for samples containing fat

Operating Design







This chapter explains the operating options available to you so that you can familiarize yourself with the moisture analyzer. There is only one key to a function, i.e., the key retains this function throughout most of the menu levels. The texts and symbols shown always have the same meaning.



Keys

Some of the keys trigger different functions, depending on whether you press the key briefly or press and hold the key:

- Press briefly = hold the key down for less than 1.2 seconds
- Press and hold = hold the key down for more than 1.2 seconds
- If you press and hold longer than 1.2 seconds, the function triggered is repeated every 0.6 seconds for as long as you hold the key.

Key	Designation	Press briefly	Press and hold
	On/off key	Switch device on or off*	–
	CF key	Analysis: cancel function Menu: cancel selection	–
	Enter key	Analysis: trigger the selected function (e.g., tare) Menu: store the selected setting	Menu: store the selected setting and tare) close the menu
	Down/Back key	Analysis: select a function (e.g., tare) Menu: decrease value or return to previous selection	Menu: decrease value 10-fold
	Up/Forward key	Analysis: select a function (e.g., tare) Menu: increase value or go to next selection	Menu: increase value 10-fold
	Print key	Send readout value or data record over the interface port	–

* When you switch off the moisture analyzer, it remains in standby mode

Display

The texts and symbols shown on the display always have the same meaning. The display is divided into several areas.

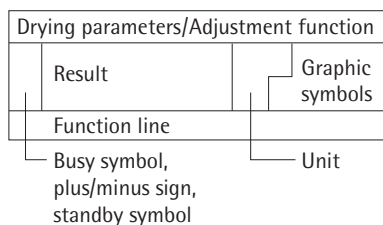

Drying parameters:

The following symbols indicate drying program parameters for information, selection and configuration:

 120 °C Target temperature

 40 min
A Fully automatic

 g
Weight unit or unit for a calculated value

 A
Analysis start

 20 min
Interval for automatic output of intermediate results

Adjustment function:

P b Adjustment function

Busy symbol, plus/minus sign, standby symbol:

The  symbol is shown here when the moisture analyzer is processing a function. The plus/minus sign for the weight value or calculated value appears here as well, and the standby symbol when the device is switched off.

Result:

This section shows the weight or calculated value.

Unit:

When the weighing system stabilizes, the unit of measurement for the weight or calculated value is displayed here.

Graphic symbols:

Which symbol is shown here depends on the operating status of the analyzer. The examples below indicate "Please close hood," "Heating the sample" and "Please wait" (hourglass).



Function line:

Press the Down/Back or Up/Forward keys to move the focus and select one of the functions shown here, and the Enter key to activate the selected function:

CAL SET PRG END START TAR







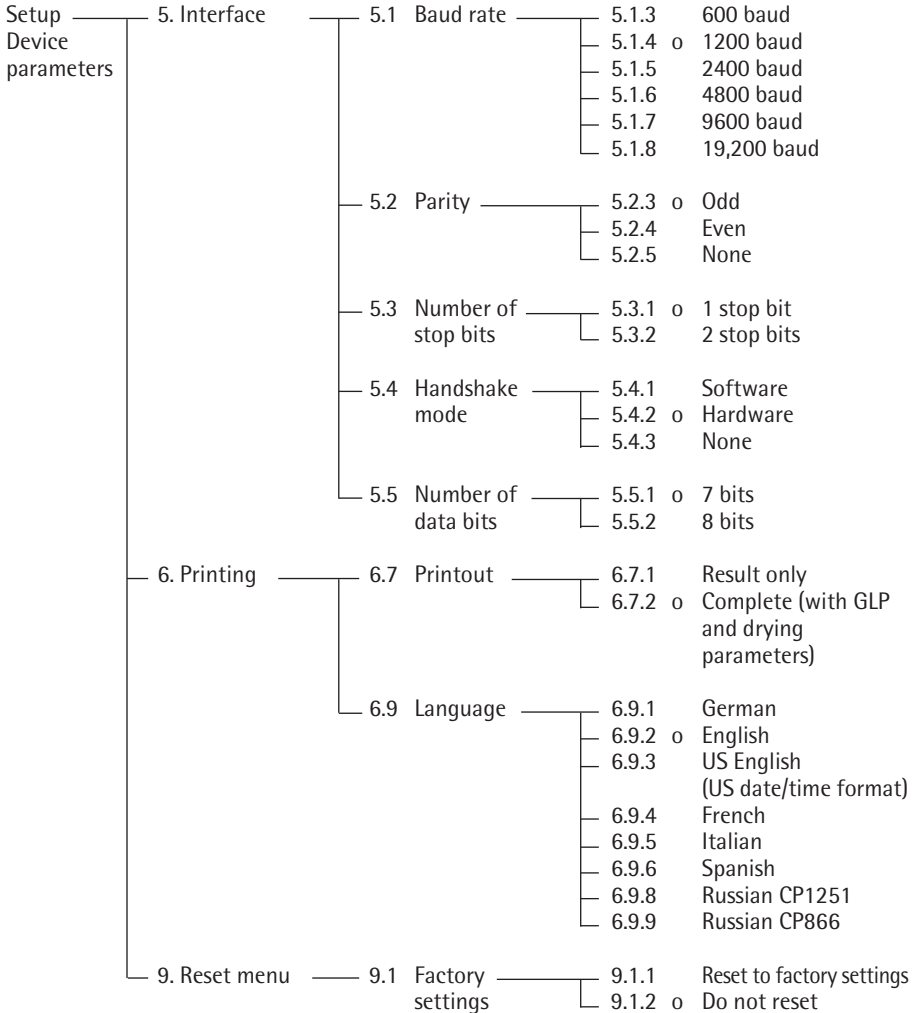



Configuration

Setting the Device Parameters

- o Factory setting







Example
Changing the language to US mode (menu item 6.9.3)

Step	Key (or instruction)	Display
1. Select SET in the function line	Repeatedly: 	
2. Confirm SET		5.
3. Select menu item 6		6.
4. Open submenu		6.7
5. Select menu item 6.9		6.9
6. Open submenu		6.9.2°
7. Select menu item 6.9.3		6.9.3
8. Confirm menu item 6.9.3		6.9.3°
9. Close the Setup menu	Repeatedly: 	

Setting the Drying Parameters

Select PRG in the function line to adapt parameters for the drying program to the particular requirements of the product sampled.

Drying Parameters

	Temperature during heating
40 ... 160°C	
	End of analysis
0.0 min	Select 0.0 minutes for fully automatic shutoff
0.1 to 99 min	Select an interval from 0.1 to 99 minutes to define a specific analysis time
	Display mode for result
%M	Moisture
%S	Dry weight
%MS	Ratio
g	Residual weight
	Start of analysis
E	With stability, after the ENTER key is pressed
A	Without stability, after the cover is closed
	Print intermediate results
Off	
0.0 min	
0.1 to 10.0 min	

Drying Parameter Features

- Heating temperature set to defined value during measurement

Start of analysis

- With stability after the **ENTER** key is pressed:
When START is shown in the function line and you press **ENTER** to confirm, the initial weight is stored at stability regardless of whether the cover is open or closed.
Measurement begins as soon as the cover is closed.
- Without stability after the cover is closed:
A symbol shown in the graphic symbol display prompts you to close the cover once the initial weight condition is met.
The initial weight is stored without stability as soon as the sample chamber is closed, and analysis begins.

End of Analysis with Shutoff Parameters

- Fully automatic mode
- Timer mode

Fully automatic mode:

Use the fully automatic mode when loss of weight on drying follows a clearly delineated curve which can be unambiguously evaluated (see below).

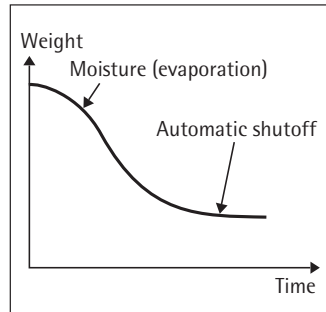

Timer mode:

The analysis ends as soon as the specified time has elapsed.

Display Mode for Result

The following units can be selected for displaying analysis results:















- Moisture %M
- Dry weight %S
- Ratio %MS
- Residual weight g













Print Intermediate Results

Intermediate results can be printed either at user-definable intervals or by pressing the **PRINT** key.

Example: setting the following drying parameters

Heating temperature: 130°C
 Start of analysis: without stability after the cover is closed
 End of analysis: after 10 minutes
 Display mode for result: moisture

Step	Key (or instruction)	Display
1. Turn on the analyzer		Self-test runs 
2. Select PRG: drying program parameters		<u>PRG</u>
3. Confirm PRG (the previously set temperature is displayed; in this example, 105°C)		<u> 105°C</u>
4. Set the heating temperature (in this example: 130°C)	 repeatedly	<u> 130°C</u>
5. Confirm heating temperature (the previously set analysis time is displayed; in this example, 0.0 min)		<u> 0.0 min</u>
6. Set the parameter for the end of analysis; in this example, 10 minutes)	 repeatedly	<u> 10 min</u>
7. Confirm the "end of analysis" parameter		<u></u>
8. Select the result display mode (in this example, moisture)	 or 	<u>%M</u>

Step	Key (or instruction)	Display
9. Confirm the display mode		 <i>E</i>
10. Select the start parameter (in this example, W/o stability after the cover is closed)	 or 	 <i>A</i>
11. Confirm the start parameter		 <i>10 min</i>
12. Select setting for printout of intermediate results (in this example, no printout = 0.0)	 repeatedly	 <i>0.0 min</i>
13. Confirm setting for intermediate printout of results		 <i>130°C</i>
14. Save changes and exit menu for drying parameter input	 > 2 sec	

Operation

Example: Analysis with Specified Drying Time











The specified drying time in the example is 10 minutes.

Heating temperature: 130°C

Start of analysis: Without stability after the cover is closed

End of analysis: After 10 minutes

Display mode: Moisture

Step	Key (or instruction)	Display
1. Switch on the moisture analyzer		Self-test runs 
2. Set the drying parameters (see "Setting the Drying Parameters" in the chapter entitled "Configuration")		
3. Open the sample chamber and place an unused sample pan on the pan support		
4. Tare the sample pan: select TAR ...and confirm	 or  as needed 	
5. Distribute approx. 2 g sample evenly on the sample pan		
6. Close the sample chamber		

The printout header is printed:
see next page

Step	Key (or instruction)	Display
------	----------------------	---------

The printout header is printed

```

-----
23.08.2005      11:25 *)
Model          MA35M-230N
Ser. no.       99992581
Ver. no.       00-33-01
ID
-----
Temp.          130 °C
Start          W/O STABI.
End            10.0 min
IniWt +       2.036 g
-----

```

*) Date and time included only if a Sartorius printer model YDP20-OCE is used

Current moisture loss and elapsed time are displayed (in this example, 0.36% moisture after 0.3 min)



Drying stops automatically after 10 minutes



The footer of the printout is printed

```

-----
10.0 +         10.90 %M
FinWt +        1.814 g
Name:
-----

```



You can print the result as often as you wish by pressing . Printout when function canceled: ("B" stands for "Break")

```

-----
10.0 +         10.90 %M
B 5.7 +        0.03 %M
-----

```

7. Clear the display 

During and after the analysis you can change the mode for display and printout of results at any time by pressing the  and  keys.

Adjusting the Analyzer

Heating Element Adjustment

The procedure for adjusting the heating element is described in the instructions supplied with the YTM15MA temperature adjustment set.

Weighing System Adjustment

To adjust the weighing system, perform calibration and adjustment as described in the following.

Purpose

Calibration is the determination of the difference between the weight readout and the true weight (mass) of a sample. Calibration does not entail making any changes within the weighing system.

Adjustment is the correction of the difference between the measured value displayed and the true weight (mass) of a sample, or the reduction of the difference to a level within specified permissible error limits.

Features















Calibration is performed externally with the following weight value:







- MA35: 30 g; see "Accessories," order no. YSS43-02

You can have calibration and adjustment results documented as a ISO/GLP-compliant printout (see the page after next for an example).

External Calibration and Adjustment with a Factory-Defined Weight

Externally calibrate and adjust the weighing system using a 30-g calibration weight

Step	Key (or instruction)	Display
1. Turn on the analyzer		Self-test runs 
2. Select CAL for calibration/ adjustment		
3. Confirm CAL		
4. Confirm again when Pb is shown		
5. Tare the weighing system		
6. Select CAL again		
7. Confirm CAL		

Step	Key (or instruction)	Display
The prompt for calibration weight is displayed		
8. Open the hinged cover		
9. Place the 30-weight on the weighing system Minus sign -: weight value too low Plus sign +: weight value too high No sign: weight value OK		
The weight unit symbol (g) is displayed at the end of adjustment		
Printout after calibration and adjustment *) Date and time included only if a Sartorius printer model YDP20-OCE is used		<pre> ----- 23.03.2017 10:51 *) Model MA35M-230N Ser. no. 99992581 Ver. no. 00-33-01 ID ----- </pre>
		<pre> ----- External calibration W-ID Nom. + 30.000 g Diff. + 0.001 g External adjustment Diff. + 0.000 g completed ----- Name: ----- </pre>
10. Unload the analyzer Close the cover		
11. Quit calibration/adjustment		

Interface Port

Purpose

The moisture analyzer has an interface port for connecting an external printer or computer (or other peripheral device).

External Printer

You can use an external printer to generate printouts.

Computer

Analyses and calculated values can be transmitted to a computer for further evaluation and for documentation.

Warning When Using Pre-wired RS-232 Connecting Cables:

RS-232 cables purchased from other manufacturers often have pin assignments that are incompatible with Sartorius products. Be sure to check the pin assignments against the chart on the next page before connecting the cable, and disconnect any lines identified differently from those specified by Sartorius (e.g., pin 11). Failure to do so may damage or even completely ruin your moisture analyzer and/or peripheral device(s).

Preparation

For instructions on adapting the interface port to the peripheral device, please refer to the chapter entitled "Configuration."

To get the most from the versatile characteristics of your moisture analyzer with regard to documentation of results, we recommend connecting a printer from Sartorius. The resulting printouts will contribute decisively to simplifying GLP-compliant practices.

Female Interface Connector

25-position D-Submini (DB25S) with screw lock hardware for cable gland

Required Male Connector

25-pin D-Submini (DB25S) with shielded cable clamp assembly (Amp type 826 985-1C) and fastening screws (Amp type 164 868-1).

Pin assignments in the 25-contact RS-232 female connector

- Pin 1: Signal ground
- Pin 2: Data output (TxD)
- Pin 3: Data input (RxD)
- Pin 4: Not connected
- Pin 5: Clear to send (CTS)
- Pin 6: Not connected
- Pin 7: Internal ground (GND)
- Pin 8: Not connected
- Pin 9: Not connected
- Pin 10: Not connected
- Pin 11: Rechargeable battery: charge voltage
+10 V (1_out 25 mA)
- Pin 12: Reset_Out *)
- Pin 13: +5 V output
- Pin 14: Internal ground (GND)
- Pin 15: Not connected
- Pin 16: Not connected
- Pin 17: Not connected
- Pin 18: Not connected
- Pin 19: Not connected
- Pin 20: Data terminal ready (DTR)
- Pin 21: Not connected
- Pin 22: Not connected
- Pin 23: Not connected
- Pin 24: Not connected
- Pin 25: +5 V output

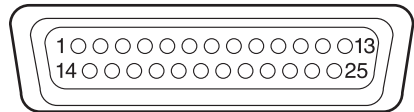

*) = Peripheral device restart

Error Codes

Error codes are displayed dynamically, for 2 seconds, or permanently. After a code is displayed dynamically or for 2 seconds, the program returns automatically to the normal operating mode.

Display	Cause	Solution
H	The load exceeds the weighing	Unload the pan support capacity
L or Err54	Load is below the weighing range	Place the pan support on the weighing system
Err 01	Data output not compatible with output format	Change the configuration in the Setup menu
Err 02	Calibration/adjustment condition not met, e.g., – not tared – the pan support is loaded	Calibrate only when zero is displayed Select TAR to tare Unload the moisture analyzer
Err 03	Calibration/adjustment could not be completed within a certain time	Allow the scale to warm up again and repeat the adjustment
Err 30	Interface port for printer output is blocked	Have the port setting changed by Sartorius Service
Err 31	Peripheral device not responding (interface handshake interrupted; XOFF, CTS)	Send XON, release CTS
Err 50	Temperature compensation overflow/underflow	Contact Sartorius Service
Err 53	Temperature compensation not functioning	Contact Sartorius Service
Err 55	Output from weighing ADC too high	Contact Sartorius Service
Err 79	Dryer adjustment data not found	Contact Sartorius Service
Err 241, Err 243	Weighing system parameters (EEPROM) defective	Switch the analyzer off and then on again. If the error persists, contact Sartorius Service
Err 2xx	Internal error	Contact Sartorius Service
Err 340	Operating parameters (EEPROM) incorrect	Contact Sartorius Service
Err 342	Operating parameters (EEPROM) incorrect except adjustment parameters	Contact Sartorius Service

If any other errors occur, contact Sartorius Service.

Contact information: Please point your Internet browser to: <http://www.sartorius.com>

Care and Maintenance

Service

Regular servicing by a Sartorius Service technician will extend the service life of your analyzer and ensure its continued accuracy of measurement. Sartorius can offer you service contracts, with your choice of regular maintenance intervals ranging from 1 month to 2 years.

The optimum length of the service interval depends on the operating conditions at the place of installation and on your requirements.

Repairs

Repair work must be performed by trained service technicians. Any attempt by untrained persons to perform repairs may result in considerable hazards for the user.

Cleaning



Make sure that no dust or liquid enters the moisture analyzer housing



Do not use any aggressive cleaning agents (solvents, abrasive cleaning agents, etc.); clean the moisture analyzer using a piece of cloth which has been wet with a mild detergent (soap) only

- Disconnecting the power supply: unplug the power cord from the wall outlet (mains supply); if you have a cable connected to the interface, unplug it from the moisture analyzer
- The pan draft shield and the pan support can be removed for cleaning
- Carefully remove any sample residue/spilled powder using a brush or a handheld vacuum cleaner
- After cleaning, wipe down the analyzer with a soft, dry cloth

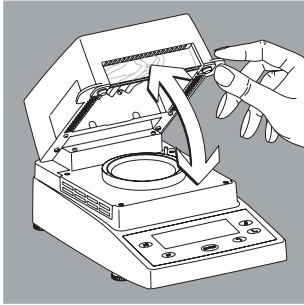

Cleaning the Heating Unit and Temperature Sensor

- Open the hinged cover

⚠ Danger: The terminals of the heating unit are under live current

- Disconnect the power supply by unplugging the power cord from the wall outlet (mains)
If you have a cable connected to the interface port, disconnect it from the moisture analyzer

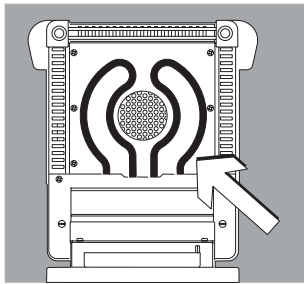

- Carefully remove any residue from the temperature sensor

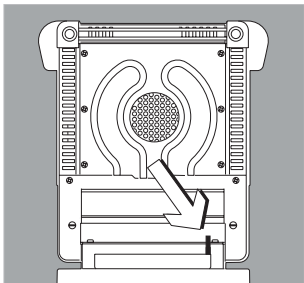

- Use a brush or a damp, lint-free cloth to clean the tubular metal heating element.

Disposal

Safety Inspection

If there is any indication that safe operation of the equipment is no longer warranted:

- Disconnect the power supply by unplugging the power cord from the wall outlet (mains)
- > Lock the equipment in a secure place to ensure that it cannot be used for the time being

Safe operation of the equipment is no longer ensured when:

- there is visible damage to the device or power cord,
- the analyzer no longer functions properly,
- the equipment has been stored for a relatively long period under unfavorable conditions, or
- the equipment has been subjected to rough handling during shipment.

In this case, notify Sartorius Service. Maintenance and repair work may be performed only by service technicians who are authorized by Sartorius and who:

- have access to the required service and maintenance manuals, and
- have attended the relevant service training courses.

A qualified Sartorius service technician should determine which tests are performed at what intervals, based on ambient and operating conditions. Inspections must be performed at least once a year.



The packaging is made of environmentally friendly materials that can be used as secondary raw materials. Packaging that is no longer needed can be

disposed of in Germany free of charge via the VfW dual system (contract number D-59101-2009-1129). Otherwise, dispose of the material at your local waste management facility according to the applicable regulations. The equipment, including accessories and batteries, does not belong in your regular household waste. EU legislation requires its Member States to collect electrical and electronic equipment and dispose of it separately from other unsorted municipal waste with the aim of recycling it. For disposal or recycling, please contact our service staff on site. In addition, the partners listed on the following website are available within the EU:

- 1) Go to <http://www.sartorius.com>.
- 2) Select "Services" under "Lab Products & Services."
- 3) Then select "Information on Disposal."
- 4) Addresses for local Sartorius disposal contacts can be found in the PDF files available for download on this page.

Devices contaminated with hazardous materials (NBC contamination) will not be accepted for repair or disposal.

Service Address for Disposal

Detailed information, including service addresses for returning your device for repair or disposal, can be found on our website (www.sartorius.com) or requested from a Sartorius Service Center.

Overview

Specifications

Weighing capacity (Max)	35 g
Typical reproducibility of the weighing system	Starting at an initial sample weight of approx. 1 g: $\pm 0.2\%$ Starting at an initial sample weight of approx. 5 g: $\pm 0.05\%$
Readability	1 mg; 0.01%
Typical sample quantity	5 – 15 g
Display of results	% moisture % dry weight % ratio g residual weight
Shutoff parameter	optional: – Fully automatic – Manual shutoff – Timer settings 0.1–99 min
Sample heating	Even sample heating capability with an IR dark radiator (metal tube heater)
Access to sample chamber	– through hinged, flip-up cover with wide opening angle – with viewing window
Draft shield	Integrated draft shield
For conformity with FDA/HACCP regulations	Aluminum panels (in place of glass panels)
Operating temperature range and setting	40°C to 160°C (104°F to 320°F), adjustable in 1°C increments
Operator guidance	Symbols representing corresponding functions
Heating program	Standard drying
Measuring program	1 program saved in a non-volatile memory (freely selectable parameters)
Memory for data storage	Results are saved until the start of the next measurement
Log printout	– Inalterable standard configuration GLP report for measurement results/calibration/adjustment – Short report for measurement results minimizing paper usage – Using an optional external printer
Data interface	RS232 C-S/VA24-V28, 7 data bits (ASCII) 1 parity bit
Monitoring and control of the accuracy of the analyzer as inspection, measuring and test equipment	External calibration with optional calibration weights; Temperature adjustment with an optional adjustment set
Housing dimensions (W × D × H)	224 × 366 × 191 mm
Net weight	approx. 5.8 kg
Power requirements (supply voltage)	230 V or 115 V (depending on the model) (–15% ... +10%)
Frequency	50 – 60 Hz
Fuses	2 (zero conductor/phase), 6.3 A, time-lag (slow-blow), 5 × 20 mm (internal)
Power consumption	max. 400 VA

Ambient conditions:

Operating temperature range	+10°C ... +30°C (+50°F ... +86°F)
Allowable ambient operating temperature	+5°C ... +40°C (+41°F ... +104°F)
Ambient storage temperature	-20°C ... +70°C (-4°F ... +158°F)
Relative humidity	Up to 80% at +31°C (+ 88°F) ambient temperature; linearly decreasing down to 50% at +40°C (+104°F), non-condensing
Operating altitude	For use above sea level up to 2,000 m (6,562 feet); indoor use only

Accessories (Options)

Accessories	Order No.
80 disposal sample pans Aluminum; 90 mm Ø	6965542
80 glass fiber filters For liquid and pasty samples and samples with high fat-content	6906940
Exchangeable panels for flip-open cover Replaces glass with aluminum panels for compliance with FDA/HACCP regulations (upgrade kit)	YDS05MA
Model YDP20-OCE data printer for external connection	YDP20-OCE
Color ink ribbon for YDP20-OCE data printer	6906918
Paper for YDP20-OCE data printer; 5 rolls; length: 50 m	6906937
External calibration weight 30 g ± 0.3 mg	YSS43-02
Temperature adjustment set	YTM15MA
Standard Operating Procedure (SOP)	YSL02MA

EU Declaration of Conformity

SARTORIUS



Original

EG-/EU-Konformitätserklärung EC / EU Declaration of Conformity

Hersteller **Sartorius Lab Instruments GmbH & Co. KG**
Manufacturer 37070 Goettingen, Germany

erklärt in alleiniger Verantwortung, dass das Betriebsmittel
declares under sole responsibility that the equipment

Geräteart **Feuchtebestimmer**
Device type *Moisture Analyzer*

Baureihe **MA35M-230N, MA35M-115N, MA35M-115US, MA35M-1CN230V1**
Type series

in der von uns in Verkehr gebrachten Ausführung allen einschlägigen Bestimmungen der folgenden Europäischen Richtlinien entspricht und die anwendbaren Anforderungen folgender harmonisierter Europäischer Normen einschließlich deren zum Zeitpunkt der Erklärung geltenden Änderungen erfüllt:

in the form as delivered fulfils all the relevant provisions of the following European Directives and meets the applicable requirements of the harmonized European Standards including any amendments valid at the time this declaration was signed listed below:

Richtlinie
Directive
Norm(en)
Standard(s)

EMV / EMC	RoHS	Niederspannung / Low Voltage
2014/30/EU	2011/65/EU	2014/35/EU
EN 61326-1:2013	EN 50581:2012	EN 61010-1:2010

Die Person, die bevollmächtigt ist, die technischen Unterlagen zusammenzustellen:
The person authorised to compile the technical file:

Sartorius Lab Instruments GmbH & Co. KG
Electronics & Product Compliance
37070 Goettingen, Germany

Sartorius Lab Instruments GmbH & Co. KG
Goettingen, 2021-05-18



Dr. Reinhard Baumfalk
Head of Product Development (LPS Division)



Halil Yildirim
Product Compliance Officer (SLI)

FCC Supplier's Declaration of Conformity

FCC Supplier's Declaration of Conformity



Device type Moisture Analyzer

Type series MA35M-000115V1, MA35M-000115V2, MA35M-000115V3

Party issuing Supplier's Declaration of Conformity / Responsible Party – U.S. Contact Information

Sartorius Corporation
5 Orville Dr Suite 200
11716 Bohemia, NY
USA
Telephone: +1.631.254.4249

FCC Compliance Statement

This device complies with Part 15 of the FCC Rules. Operation is subject to the following two conditions: (1) This device may not cause harmful interference, and (2) this device must accept any interference received, including interference that may cause undesired operation.

Information to the user

Note: This equipment has been tested and found to comply with the limits for a **class B** digital device, pursuant to part 15 of the FCC Rules. These limits are designed to provide reasonable protection against harmful interference in a residential installation. This equipment generates, uses and can radiate radio frequency energy and if not installed and used in accordance with the instructions, may cause harmful interference to radio communications. However, there is no guarantee that interference will not occur in a particular installation. If this equipment does cause harmful interference to radio or television reception, which can be determined by turning the equipment off and on, the user is encouraged to try to correct the interference by one or more of the following measures:

- Reorient or relocate the receiving antenna.
- Increase the separation between the equipment and receiver.
- Connect the equipment into an outlet on a circuit different from that to which the receiver is connected.
- Consult the dealer or an experienced radio/TV technician for help.

Connections between the device and peripherals must be made using shielded cables in order to maintain compliance with FCC radio frequency emission limits.

Any modifications made to this device that are not approved by Sartorius may void the authority granted to the user by the FCC to operate this equipment.

CSA Certificate of Compliance



Certificate of Compliance

Certificate: 2251693 **Master Contract:** 167555
Project: 2706857 **Date Issued:** March 19, 2014
Issued to: Sartorius Lab Instruments
GmbH & Co. KG
94-108 Weender Landstrasse
Goettingen, 37075
Germany
Attention: Dr. Dieter Klausgrete

The products listed below are eligible to bear the CSA Mark shown with adjacent indicators 'C' and 'US' for Canada and US or with adjacent indicator 'US' for US only or without either indicator for Canada only.



Timothy Stafrace
Issued by: Timothy Stafrace, C.E.T.

PRODUCTS

CLASS 8721 85 - ELECTRICAL EQUIPMENT FOR LABORATORY USE - Certified to US Standards
CLASS 8721 05 - LABORATORY EQUIPMENT - Electrical

Moisture Analyzer, Models MATTTW-XXXXYYZZ and IRTTTW-XXXXYYZZ

Where: TTT = Weighing range (up to 3 numbers), W = Heating element; in this case letter M only
XXX = up to 3 letters or numbers for special versions (e.g. 0CE), YYY = mains voltage (e.g. 115 for 100-120V)
ZZ = up to 2 letters or numbers for special versions (e.g. V1, V2).

Rated 100 - 120 Vac, 50/60 Hz; 230 Vac, 50/60 Hz, 400 VA.

Installation Category II, Pollution Degree 2, Continuous operation, Class I equipment.



Certificate: 2251693

Master Contract: 167555

Project: 2706857

Date Issued: March 19, 2014

APPLICABLE REQUIREMENTS

CSA Standards:

CAN/CSA-C22.2 No. 61010-1-04 - Safety Requirements for Electrical Equipment for Measurement, Control, and Laboratory Use, Part 1: General Requirements

UL Standards:

UL Std. No. 61010-1 (2nd Edition) - Safety Requirements for Electrical Equipment for Measurement, Control, and Laboratory Use - Part 1: General Requirements

Sartorius Lab Instruments GmbH & Co. KG
Otto-Brenner-Strasse 20
37079 Goettingen, Germany

Phone: +49 551 308 0
www.sartorius.com

The information and figures contained in these instructions correspond to the version date specified below.

Sartorius reserves the right to make changes to the technology, features, specifications and design of the equipment without notice.

Masculine or feminine forms are used to facilitate legibility in these instructions and always simultaneously denote the other gender as well.

Copyright notice:

This instruction manual, including all of its components, is protected by copyright.

Any use beyond the limits of the copyright law is not permitted without our approval.

This applies in particular to reprinting, translation and editing irrespective of the type of media used.

© Sartorius Germany

Last updated:
06 | 2021

Printed in the EU on paper bleached
without chlorine. | AM
Publication No.: WMA6030-e210602