

AeroTrak™ + Portable Airborne Particle Counter



Models A100-31/31A/35/35A/
50/50A/51/51A/55/55A

Operation Manual

P/N 6016408, Revision C
October 2023



Start Seeing the Benefits of Registering Today!

Thank you for your TSI® instrument purchase. Occasionally, TSI® releases information on software updates, product enhancements and new products. By registering your instrument, TSI® will be able to send this important information to you.

<http://register.tsi.com>

As part of the registration process, you will be asked for your comments on TSI products and services. TSI's customer feedback program gives customers like you a way to tell us how we are doing.

AeroTrak™ + Portable Airborne Particle Counter



Models A100-31/31A/35/35A/
50/50A/51/51A/55/55A

Operation Manual

P/N 6016408, Revision C
October 2023

Ship To/Mail To:
TSI Incorporated
500 Cardigan Road
Shoreview, MN 55126-3996
USA

**U.S.
Technical Support:**
(800) 680-1220/(651) 490-2860
Fax:
(651) 490-3824

E-mail address:
technical.services@tsi.com

Website:
<http://www.tsi.com>

**International
Technical Support:**
(001 651) 490-2860
Fax:
(001 651) 490-3824

Manual History

The following is a manual history of the AeroTrak™+ Portable Airborne Particle Counter, Models A100-31/31A/35/35A/50/50A/51/51A/55/55A Operation Manual (P/N 6016408).

Revision	Date
A	February 2023
B	May 2023
C	October 2023

Warranty

Part Number	6016408 / Revision C / October 2023
Copyright	©TSI Incorporated / 2023 / All rights reserved.
Address	TSI Incorporated / 500 Cardigan Road / Shoreview, MN 55126 / USA
E-mail Address	answers@tsi.com
Limitation of Warranty and Liability	<p>(For country-specific terms and conditions outside of the USA, please visit www.tsi.com.)</p> <p>Seller warrants the goods, excluding software, sold hereunder, under normal use and service as described in the operator's manual, to be free from defects in workmanship and material for the longer period of either 24 months, or the length of time specified in the operator's manual/warranty statement provided with the goods or made available electronically (version published at the time of sale), from the date of shipment to the customer. This warranty period is inclusive of any statutory warranty. This limited warranty is subject to the following exclusions and exceptions:</p> <ol style="list-style-type: none">Hot-wire or hot-film sensors used with research anemometers, and certain other components when indicated in specifications, are warranted for 90 days from the date of shipment;Pumps are warranted for hours of operation as set forth in product or operator's manuals;Parts repaired or replaced as a result of repair services are warranted to be free from defects in workmanship and material, under normal use, for 90 days from the date of shipment;Seller does not provide any warranty on finished goods manufactured by others or on any fuses, batteries or other consumable materials. Only the original manufacturer's warranty applies;This warranty does not cover calibration requirements, and seller warrants only that the instrument or product is properly calibrated at the time of its manufacture. Instruments returned for calibration are not covered by this warranty;This warranty is VOID if the instrument is opened by anyone other than a factory authorized service center with the one exception where requirements set forth in the manual allow an operator to replace consumables or perform recommended cleaning;This warranty is VOID if the product has been misused, neglected, subjected to accidental or intentional damage, or is not properly installed, maintained, or cleaned according to the requirements of the manual. Unless specifically authorized in a separate writing by Seller, Seller makes no warranty with respect to, and shall have no liability in connection with, goods which are incorporated into other products or equipment, or which are modified by any person other than Seller.New parts or components purchased are warranted to be free from defects in workmanship and material, under normal use, for 90 days from the date of shipment.

The foregoing is **IN LIEU OF** all other warranties and is subject to the **LIMITATIONS** stated herein. **NO OTHER EXPRESS OR IMPLIED WARRANTY OF FITNESS FOR PARTICULAR PURPOSE OR MERCHANTABILITY IS MADE. WITH RESPECT TO SELLER'S BREACH OF THE IMPLIED WARRANTY AGAINST INFRINGEMENT, SAID WARRANTY IS LIMITED TO CLAIMS OF DIRECT INFRINGEMENT AND EXCLUDES CLAIMS OF CONTRIBUTORY OR INDUCED INFRINGEMENTS. BUYER'S EXCLUSIVE REMEDY SHALL BE THE RETURN OF THE PURCHASE PRICE DISCOUNTED FOR REASONABLE WEAR AND TEAR OR AT SELLER'S OPTION REPLACEMENT OF THE GOODS WITH NON-INFRINGING GOODS.**

TO THE EXTENT PERMITTED BY LAW, THE EXCLUSIVE REMEDY OF THE USER OR BUYER, AND THE LIMIT OF SELLER'S LIABILITY FOR ANY AND ALL LOSSES, INJURIES, OR DAMAGES CONCERNING THE GOODS (INCLUDING CLAIMS BASED ON CONTRACT, NEGLIGENCE, TORT, STRICT LIABILITY OR OTHERWISE) SHALL BE THE RETURN OF GOODS TO SELLER AND THE REFUND OF THE PURCHASE PRICE, OR, AT THE OPTION OF SELLER, THE REPAIR OR REPLACEMENT OF THE GOODS. IN THE CASE

OF SOFTWARE, SELLER WILL REPAIR OR REPLACE DEFECTIVE SOFTWARE OR IF UNABLE TO DO SO, WILL REFUND THE PURCHASE PRICE OF THE SOFTWARE. IN NO EVENT SHALL SELLER BE LIABLE FOR LOST PROFITS, BUSINESS INTERRUPTION, OR ANY SPECIAL, INDIRECT, CONSEQUENTIAL OR INCIDENTAL DAMAGES. SELLER SHALL NOT BE RESPONSIBLE FOR INSTALLATION, DISMANTLING OR REINSTALLATION COSTS OR CHARGES. No Action, regardless of form, may be brought against Seller more than 12 months after a cause of action has accrued. The goods returned under warranty to Seller's factory shall be at Buyer's risk of loss, and will be returned, if at all, at Seller's risk of loss.

Buyer and all users are deemed to have accepted this LIMITATION OF WARRANTY AND LIABILITY, which contains the complete and exclusive limited warranty of Seller. This LIMITATION OF WARRANTY AND LIABILITY may not be amended, modified or its terms waived, except by writing signed by an Officer of Seller.

Service Policy

Knowing that inoperative or defective instruments are as detrimental to TSI as they are to our customers, our service policy is designed to give prompt attention to any problems. If any malfunction is discovered, please contact your nearest sales office or representative, or call TSI's Customer Service department at 1-800-680-1220 (USA) or +001 (651) 490-2860 (International).

Trademarks

TSI and the TSI logo are registered trademarks of TSI Incorporated in the United States and may be protected under other country's trademark registrations. Modbus is a registered trademark of Modicon, Inc. Wi-Fi is a registered trademark of the Wi-Fi Alliance. The Bluetooth® word mark and logos are registered trademarks owned by Bluetooth SIG, Inc. and any use of such marks by TSI Incorporated is under license. Other trademarks and trade names are those of their respective owners.

Patents

www.tsi.com/patents

Contents

Manual History	ii
Warranty	iii
Contents	v
Safety Information	vii
Laser Safety and Radio Interference	vii
Laser Safety	vii
Radio Interference	viii
Labels	ix
Description of Caution/Warning Symbols	x
Caution	x
Warning	x
Caution or Warning Symbols	x
Getting Help	xi
CHAPTER 1 Introduction and Unpacking	1-1
Unpacking the AeroTrak™+Portable Airborne Particle Counter	1-2
Optional Accessories	1-4
CHAPTER 2 Getting Started	2-1
Instrument Description	2-1
Providing Power	2-3
To Install the Lithium-Ion Battery	2-4
To Use AC Power	2-4
Using the Thermal Printer	2-5
Using Peripherals	2-5
External Alarm	2-5
Electronic Filter Scanning Probe	2-6
Wireless/Bluetooth® Dongle	2-6
USB Flash Drive	2-6
Barcode Scanners	2-7
External Keyboard	2-7
Computer	2-7
Analog Outputs	2-8
Analog Inputs	2-8
Near Field Communications (NFC) Tags	2-9
Using an Isokinetic Sample Probe	2-9
CHAPTER 3 Operation	3-1
Powering On/Off and Sleep Mode	3-1
Using the On-screen Keyboard/Keypad	3-2
Software Input Panel (Keyboard or Keypad)	3-2
Main Status Bar	3-3
Sampling	3-4
Sampling Basics	3-5
Manual Mode	3-7
Monitor and Classify	3-7

Zero.....	3-8
Scan.....	3-8
Purge.....	3-8
Creating Zones and Locations	3-8
Create Zone - Monitor.....	3-9
Create Zone – Classify	3-11
Editing, Duplicating, or Deleting a Zone	3-13
Using Workflows.....	3-14
Records and Reports	3-16
Viewing Sample Records.....	3-17
Exporting Sample Records	3-17
Report Generation	3-18
Settings.....	3-18
Date/Time.....	3-19
Data Integrity.....	3-20
Security Settings	3-20
Manage Accounts	3-21
Manage Data.....	3-23
Audit Trails	3-24
Information	3-24
Import Configuration	3-25
Network.....	3-25
Printer Setup.....	3-26
Device Name/Language	3-26
Display/Power/Audio.....	3-27
Near Field Communications.....	3-27
Analog In/Out.....	3-29
CHAPTER 4 Maintenance	4-1
Maintenance Schedule.....	4-1
Cleaning the Instrument Enclosure	4-1
CHAPTER 5 Troubleshooting.....	5-1
CHAPTER 6 Contacting Customer Service.....	6-1
Technical Contacts.....	6-1
International Contacts	6-1
Service	6-1
Technical Support.....	6-2
Returning for Service.....	6-3
APPENDIX A Specifications	A-1
Compliance.....	A-3
Dimensional Diagram	a-4

Safety Information

This section gives instructions to promote safe and proper handling of the AeroTrak™+ Portable Airborne Particle Counter.



IMPORTANT NOTICE

There are no user-serviceable parts inside the instrument. Refer all repair and maintenance to a qualified factory-authorized technician. All maintenance and repair information in this manual is included for use by a qualified factory-authorized technician.

Laser Safety and Radio Interference

Laser Safety

- This Portable Airborne Particle Counter is a Class I laser-based instrument.
- During normal operation, you **WILL NOT** be exposed to laser radiation.
- Precaution should be taken to avoid exposure to hazardous radiation in the form of intense, focused, visible light.
- Exposure to this light may cause blindness.

Take these precautions:

- **DO NOT** remove any parts from the particle counter unless you are specifically told to do so in this manual.
- **DO NOT** remove the housing. There are no user-serviceable components inside the housing.



WARNING

The use of controls, adjustments, or procedures other than those specified in this manual may result in exposure to hazardous optical radiation.



ATTENTION

L'utilisation de commandes, de réglages ou de procédures autres que ceux spécifiés dans ce manuel peut une exposition à un rayonnement optique dangereux.

Radio Interference

- This device contains license-exempt transmitter(s)/receiver(s) that comply with Innovation, Science and Economic Development Canada's license-exempt RSS(s). Operation is subject to the following two conditions¹:
 - This device may not cause interference.
 - This device must accept any interference, including interference that may cause undesired operation of the device.
- Le présent appareil est conforme aux CNR d'Industrie Canada applicables aux appareils radio exempts de licence. L'exploitation est autorisée aux deux conditions suivantes:
 - l'appareil ne doit pas produire de brouillage, et
 - l'utilisateur de l'appareil doit accepter tout brouillage radioélectrique subi, même si le brouillage est susceptible d'en compromettre le fonctionnement.



¹ Per FCC 15.19(a)(3) and (a)(4) This device complies with part 15 of the FCC Rules. Operation is subject to the following two conditions: (1) This device may not cause harmful interference, and (2) this device must accept any interference received, including interference that may cause undesired operation.

Per FCC 15.21, any changes or modifications not expressly approved by the party responsible for compliance could void the user's authority to operate the equipment

To satisfy RF exposure requirements, this device and its antenna must operate with a separation distance of at least 20 cm from all persons. Reference FCC KDB 784748, Section A.8.

Labels

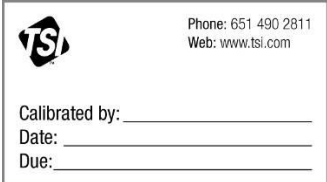
Advisory labels and identification labels are attached to the outside of the particle counter housing and to the optics housing on the inside of the instrument.

<p>1. Serial number label (<i>back panel</i>)</p>	
<p>2. Laser radiation label (<i>internal</i>)</p>	<p style="text-align: center;">DANGER! VISIBLE LASER RADIATION WHEN OPEN. AVOID DIRECT EXPOSURE TO BEAM WARNING: NO USER SERVICABLE PARTS INSIDE. REFER SERVICING TO QUALIFIED PERSONNEL</p>
<p>3. Laser instrument compliance label (<i>back panel</i>)</p>	<p style="text-align: center;">CLASS 1 LASER PRODUCT Complies with 21 CFR 1040.10 and 1040.11 Except for deviations pursuant to Laser Notice No. 50, Dated June 24, 2007</p>
<p>4. Electrical shock caution label (<i>back panel</i>)</p>	<p style="text-align: center;">CAUTION</p> <p>To avoid electrical shock, the power cord protective grounding conductor must be connected to earth ground.</p>
<p>5. Calibration label (<i>back panel</i>)</p>	
<p>6. Laser radiation symbol label (<i>back panel and internal</i>)</p>	
<p>7. European symbol for non- disposable item. Item must be recycled (<i>back panel</i>)</p>	

Description of Caution/Warning Symbols

Appropriate caution/warning statements are used throughout the manual and on the instrument that require you to take cautionary measures when working with the instrument.

Caution



CAUTION
Failure to follow the procedures prescribed in this manual might result in irreparable equipment damage. Important information about the operation and maintenance of this instrument is included in this manual.

Warning



WARNING
Warning means that unsafe use of the instrument could result in serious injury to you or cause damage to the instrument. Follow the procedures prescribed.

Caution or Warning Symbols

The following symbols may accompany cautions and warnings to indicate the nature and consequences of hazards:

	Warns that uninsulated voltage within the instrument may have sufficient magnitude to cause electric shock. Therefore, it is dangerous to make contact with any part inside the instrument.
	Warns that the instrument contains a laser and that important information about its safe operation and maintenance is included in the manual.
	Warns that the instrument is susceptible to electro-static dissipation (ESD) and ESD protection procedures should be followed to avoid damage.
	Indicates the connector is connected to earth ground and cabinet ground.

Getting Help

To obtain assistance with this product or to submit suggestions, please contact Customer Service:

TSI Incorporated
500 Cardigan Road
Shoreview, MN 55126 U.S.A.

Fax: (651) 490-3824 (USA)

Fax: 001 651 490 3824 (International)

Telephone: 1-800-680-1220 (USA) or (651) 490-2860

International: 001 651 490 2811

E-mail Address: technical.services@tsi.com

Web site: www.tsi.com

(This page intentionally left blank)

CHAPTER 1

Introduction and Unpacking

The AeroTrak™+ A100 Portable Airborne Particle Counters are optical particle counters which utilize the well-established method of detecting and sizing particles based on light scatter. It has a touch-screen interface and can operate with either AC power or the included lithium-ion battery for full portability.

These devices are available in three different flow rates and two different channel size ranges as shown in the table below.

Model	Channel Sizes	Flow Rate
A100-31	0.3 – 10.0 µm	28.3 L/min (1 CFM)
A100-35	0.3 – 10.0 µm	50 L/min (1.77 CFM)
A100-50	0.5 – 10.0 µm	100 L/min (3.53 CFM)
A100-51	0.5 – 10.0 µm	28.3 L/min (1 CFM)
A100-55	0.5 – 10.0 µm	50 L/min (1.77 CFM)

All models offer an optional Analog Input/Analog Output that is added at time of purchase. If ordered, the model name will have an “A” added to the end of the model name. Examples: A100-31A, A100-35A,

All AeroTrak™+ A100 Portable Airborne Particle Counters provide the operations, features, and reliability to meet many applications including:

- Cleanroom Certification and Monitoring
- Compressed Gas Sampling
- Aerosol/Airborne Particulate Research
- Exposure Assessment
- Indoor Air Quality
- Filter Testing
- Clearance Testing
- Quality Assurance
- Contaminant Migration Studies
- Root-cause Analysis







All AeroTrak™+ A100 Portable Airborne Particle Counters can be used with TSI® Incorporated’s TrakPro™ Lite Secure and Facility Monitoring System Software for additional functionality and improved data handling. Instructions for operating with these software packages is not included in this manual, refer to the software manuals for more information.

Unpacking the AeroTrak™ + Portable Airborne Particle Counter

Carefully unpack the AeroTrak™ + Portable Airborne Particle Counter from the shipping container and verify that all the items shown in the following tables are present. Contact [TSI®](#) immediately if items are missing or broken (see [Chapter 6, Contacting Customer Service](#) for more information).

AeroTrak™ + Portable Airborne Particle Counter Parts List

Qty.	Item Description	Part/Model	Reference Picture
1	AeroTrak™ + Airborne Particle Counter	A100-31 A100-35 A100-50 A100-51 A100-55 (Suffix A indicates analog option)	
1	Power Supply 24 VDC, 5.0A, 100-240 VAC, KPPX-4 plug	PSU-A100	
1	Country-Specific Power Cord	700057 (US) 700058 (UK) 700059 (Euro)	
1 or 2	Battery Pack (can install up to 2 ea.)	BAT-A100 Qty = 1	
3 m (10 ft)	Sample Tubing, Clear	TUBE150-A100 3/8 ID x 1/2 OD (28.3 or 50 L/min models) TUBE100-A100 1/2 ID x 5/8 OD (100 L/min model)	
1	Sample Probe, Aluminum, Isokinetic, (connects to instrument)	SPAL1-A100 (28.3 L/min) SPAL5-A100 (50 L/min) SPAL0-A100 (100 L/min)	



Qty.	Item Description	Part/Model	Reference Picture
1	Probe Mount (provides a connection to remotely sample with tubing)	SPMT150-A100 (28.3 L/min & 50 L/min) SPMT100-A100 (100 L/min)	
1	Computer Cable, USB-A to USB-C (2 meters)	700360	
1	Filter, HEPA Purge/Zero Filter Assembly	FIL150-A100 (for the 28.3 and 50 L/min model) FIL100-A100 (for the 100 L/min model)	
1	Alarm Accessories, 2-pin Alarm Connector (not wired)	ALMOUT-A100	
1	Wireless (Wi-Fi®) / Bluetooth® 4.0 Dongle USB-A, 802.11b/g/n	WIFI-B-A100	
1	Insert Card	5002751	
1	Calibration certificate	N/A	

Optional Accessories

The following table lists the available optional accessories. If you ordered optional accessories, make certain they have been received and are in working order.

AeroTrak™+ Portable Airborne Particle Counter Optional Accessories

Item Description	Part/Model	Reference Picture
Sample Probe, Stainless Steel, Isokinetic (connects to instrument)	SPSS1-A100 (28.3 L/min) SPSS5-A100 (50 L/min) SPSS0-A100 (100 L/min)	
Filter Scanning Probe (basic)	700070 (28.3 L/min) 700071 (50 L/min) 700088 (100 L/min)	
Filter Scanning Probe (electronic with start/stop, LED, sound)	700094 (28.3 L/min) 700095 (50 L/min) 700096 (100 L/min)	
Tubing, Superthane, Clear 3/8-inch ID x 1/2-inch OD (100 feet)	700062 (28.3 or 50 L/min models)	
Tubing, Superthane, Clear 1/2-inch ID x 5/8-inch OD (100 feet)	700062 (100 L/min models)	
Printer Paper (10 rolls)	700027	
Dual Battery Charger Supplied w/ US Power Cord (obtain plug adaptor locally if needed)	DBC-A100	

Item Description	Part/Model	Reference Picture
Case, Rolling Case, Heavy Duty, with foam inserts (can be used for shipping)	CCS-A100	
High Pressure Diffuser for compressed gas testing	7960 or 7955	

(This page intentionally left blank)

CHAPTER 2

Getting Started

This chapter describes the features, connections, and installation of the AeroTrak™ + Portable Airborne Particle Counter.

Instrument Description

The AeroTrak™+ Portable Airborne Particle Counter samples air (or pressurized gases with an optional High-Pressure Diffuser) and reports particle contamination levels. The instrument's design and features meets the requirements of many applications including:

- Cleanroom Certifications and Monitoring
- Gas testing with automatic flow correction
- Filter testing and certification
- Long-term data trending
- Mobile sampling and root-cause analysis troubleshooting
- Manifold monitoring of multiple points (using the M32 manifold)

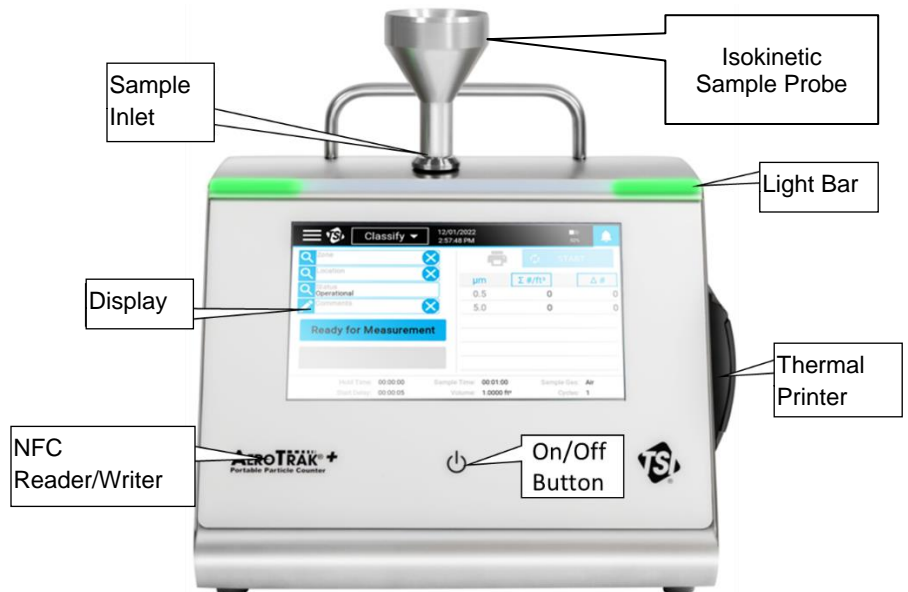

The touch-screen display provides an intuitive graphical user interface (GUI). An LED lightbar indicates when the instrument is on and provides status information during sampling. On the left side of the panel, under the AeroTrak™+ Portable Particle Counter label, is the Near-Field Communication (NFC) reader/writer that provides contactless communication.

The sample inlet is located on the top of the instrument. An isokinetic sample probe (ISP) can directly connect to the sample inlet or an ISP or scanning probe can be used with tubing to capture samples from remote locations. A handle is located on top to carry the instrument and a built-in thermal printer is located on the right side panel.

The instrument's back panel has many features that are described below.

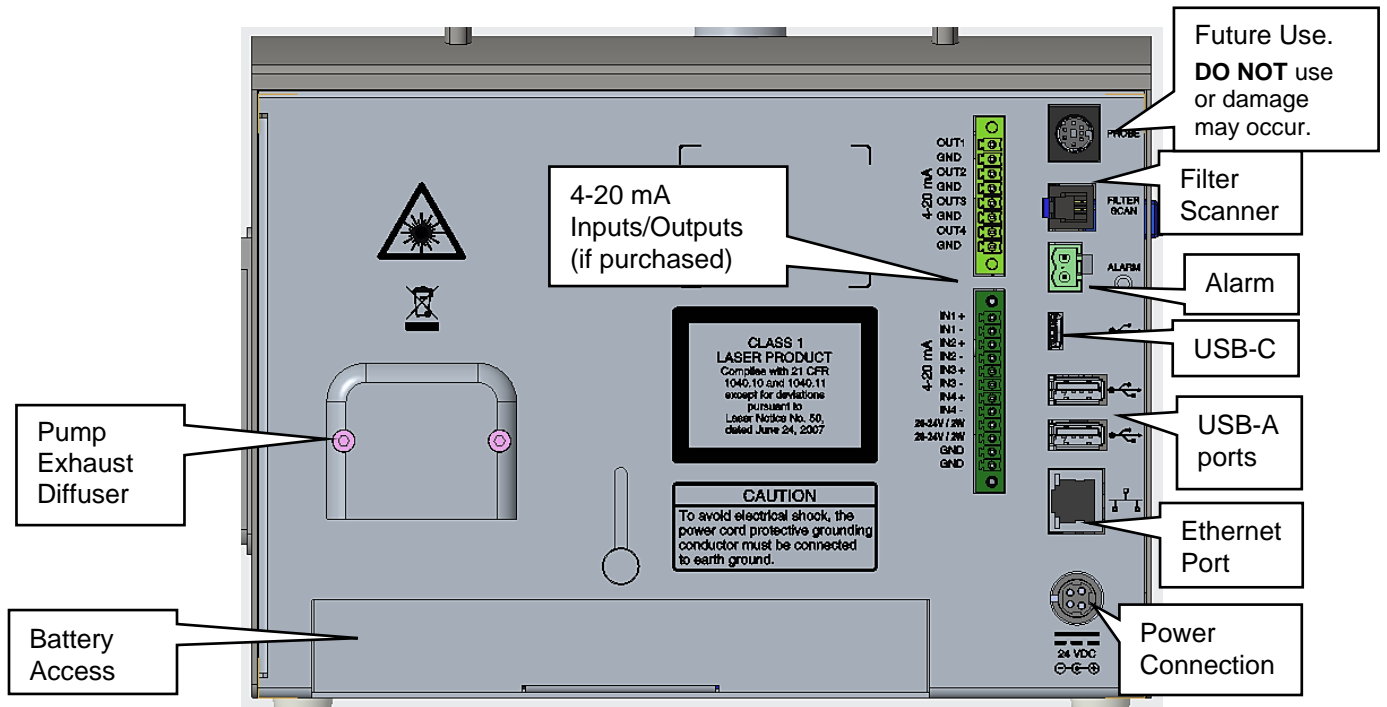

Description	Function
Battery access	This plate provides access to a battery bay. The instrument can operate with one battery installed in either slot or two batteries installed to all for longer operation. See specifications for estimated battery life.
Pump exhaust diffuser	Direct the HEPA filtered exhaust down and away from the inlet. The diffuser may be removed to allow tubing to connect to the exhaust port and vent to a remote location.
DC Power connection	The power connection is for an external power supply. Only the TSI®-supplied 24 VDC, 5.0 A power supply model PSU-A100 should be used. Orient the power connector to the back panel as indicated by the printed outline of the plug connector.

Description	Function
Alarm	The Alarm connector provides two pins for a contact closure to control an external alarm. The contact closure is normally open and rated for 0 to 60 V AC/DC at 1.5A peak, 0.5A continuous. The “alarm out” connection is rated for 60 V insulation. The contact is closed under alarm conditions that are configured by the instrument.
Filter scanner	This connector is used with the optional TSI® Electronic Filter Scanning Probes. TSI® P/N 700094 (1.0 CFM models) TSI® P/N 700095 (50 LPM models) TSI® P/N 700096 (100 LPM models)
Probe	Reserved for future use. DO NOT plug anything into this port or damage may occur.
USB-A	USB-A ports provide connections for “flash drive” devices to download instrument data and transfer to a computer or other device. The data files are in PDF or XML format for easy use in spreadsheet programs. The USB-A ports are also used for the Wireless/Bluetooth® communication dongle.
USB-C	The standard USB-C port provides communication to TSI® Incorporated’s Calibration Bench and TrakPro™ Lite Secure Software for computers.
Ethernet port	The particle counter is compatible with either 10 or 100 MBps systems. The green LED indicates that the network is connected. The yellow LED indicates activity on the network cable.
Analog Interface	Models with optional 4-20 mA analog interface are available.

Providing Power

The particle counters may be powered using rechargeable lithium-ion batteries or through an AC power cord.

NOTICES
<ul style="list-style-type: none"> ▪ When using AC power, the battery (if installed) charges when the instrument is on or while actively sampling. The battery does not charge while in Sleep mode. ▪ Removing/changing the lithium-ion battery or disconnecting AC power does not cause loss of data or instrument configuration. The AeroTrak™+ Airborne Particle Counter has an internal, non-user accessible battery to maintain settings and save logged data. ▪ The battery provided has a built-in indicator of charge level. Push on the “Check” button on the battery to see the charge level. If none of the LEDs lights up, the battery is not charged.

To Install the Lithium-Ion Battery

1. Slide up the battery door on the back of the instrument by turning the thumbscrew counterclockwise.
2. Slide the battery into the slot (it does not matter which one), pressing until it is flush with the back panel (note the orientation of the tabs). One battery is provided for all models, but up to two batteries can be used to extend operating time.
3. Slide down the battery door and secure with the thumbscrew.
4. **The batteries will only charge if the instrument is ON.** If you often use the unit with batteries, you may consider purchasing the TSI® external dual-battery charger model DBC-A100 (see [Optional Accessories](#) in Chapter 1).



NOTICE

Batteries may be “hot swapped,” if one charged battery is engaged at all times. A fully charged battery can be inserted and then the depleted battery removed without powering down the unit.



WARNING

The battery supplied by TSI® (P/N BAT-A100) has built-in protection against explosion and fire hazard. **DO NOT** use a substitute.

DO NOT use any other type of battery in this instrument. Fire, explosions, injuries, or other hazards may result.

To Use AC Power

1. Connect the supplied 24 VDC power supply to the power connection on the back of the instrument.
2. Connect the appropriate power cord into the power supply and to the external power supply.

NOTICE

The instrument turns on automatically when connected to an AC power supply.

Using the Thermal Printer

The side-mounted thermal printer is standard on all models. Manual printing can be performed whenever the Printer icon is visible and dark . Sample results can also be set to print automatically (see [Printer Setup Screen](#) on the System Settings Screen).



When installing a new roll of paper, the tag end should be from the bottom of the roll and pulled through the printer door.

The printer has a green flashing LED on the right side indicating that the printer is ready.

There is also a feed button on the left side  to allow a manual feed of the paper before tearing it off. To tear off, pull steadily down on the paper from one side of the serrated edge to the other.

Printer paper has a colored strip printed on the last few feet of each roll to indicate time to change the paper roll.

Using Peripherals

External Alarm

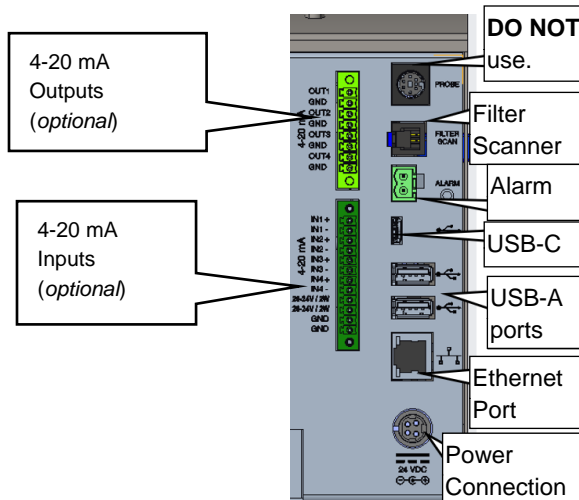

An external alarm can be connected with the provided alarm connector. Only the mating connector is provided, the external alarm and wiring must be supplied by the user. The connector provides two pins for a contact closure that controls an external alarm. The contact closure is *normally open* and rated for 0 – 60 V AC/DC at 1.5 Amps peak, and 0.5 Amps continuous. The “alarm out” connection is rated for 60 VDC insulation. The contact is *closed* under alarm conditions configured by the instrument. When used with an externally powered device (such as a light tower), the alarm closure can activate a visual or audible local alarm.



WARNING

The monitor Alarm Output function **SHOULD NOT** be used to detect hazardous conditions or to provide an alarm for protecting human life, health, or safety.



CAUTION

The alarm switch **MUST NOT** be wired to AC power! Failure to properly install the user alarm could damage the instrument and/or void the instrument warranty! Please read and follow all instructions before wiring or operating the user alarm.



WARNING

When connected to the alarm out connector, you must use safety certified equipment and/or power sources.

Electronic Filter Scanning Probe

The Filter Scan port is used with the optional TSI® Electronic Filter Scanning Probes.

Description	TSI® part/ model number
Electronic Filter Scanning Probe, 1 CFM	700094
Electronic Filter Scanning Probe, 50 LPM	700095
Electronic Filter Scanning Probe, 100 LPM	700096



Connecting the Electronic Filter Scanner Probe allows starting and stopping samples from the probe head. In addition, the alarm for exceeding a given particle concentration limit can be heard on the probe, as well as from the instrument.

Wireless/Bluetooth® Dongle

The Wireless/Bluetooth® Dongle accessory can be plugged into one of the USB-A ports.

USB Flash Drive

A USB flash drive can be plugged into one of the USB-A ports. See instructions on using a flash drive in [Chapter 2](#).

Barcode Scanners

A barcode scanner can be plugged into one of the USB-A ports. 1D barcode scanners that support USB 1.0 or 1.1 devices can be used (Zebra[®] LS2208 works well) to select an existing Zone and Location pair in the list boxes on the Main page. Barcodes must use the format ZoneName:LocationName (i.e., the zone name followed by a colon followed by the location name). The barcode can then be scanned and the specified zone and location will be automatically selected in the list boxes.



There are free online barcode generators available (i.e., <http://barcode.tec-it.com/en>). Select linear Code 128 to generate the barcodes. ProdRoom107:SecA12

External Keyboard

An external keyboard can be plugged into one of the USB-A ports as an alternative to the touch-screen keyboard.

Computer

To connect to a computer running TrakPro™ Lite Secure software, use the supplied USB-A to USB-C cable. Connect to the USB-C port on the instrument and the USB-A port on the computer.

The instrument can also be connected to a computer via the ethernet port. The particle counter is compatible with 10/100 MBps systems; the port is a standard 10/100 Mbps 8-Position 8-Contact (8P8C, often called RJ45) modular plug connection. The green LED indicates the network is connected. The yellow LED indicates activity on the network. The instrument cannot be operated using Power-over-Ethernet (PoE).

[®]Zebra is a trademark of ZIH Corp.

Analog Outputs

Data can be communicated out using the analog output. An 8-pin connector provides for four (4) channels of 4-20 mA outputs. Three (3) of the analog outputs are configurable for particle size and scaling.

Terminal	Channel	Direction
1	A	Output
2	A	Return
3	B	Output
4	B	Return
5	C	Output
6	C	Return
7	Status	Output
8	Status	Return

The last analog output (terminals 7 and 8) is dedicated to status information. The output will go to a nominal current value that corresponds to the condition listed below.

Current	Flow Status	Laser Status
8 mA	OK	OK
12 mA	OK	Alarm
16 mA	Alarm	OK
20 mA	Alarm	Alarm

Analog Inputs

Data is received from analog sensors using the analog input. A 12-pin connector provides for four (4) channels of 4-20 mA inputs. The unit is capable of supplying 24V @ 100 mA that can be used to power 4-20 mA sensors.

Terminal	Channel	Direction
1	1	Input
2	1	Return
3	2	Input
4	2	Return
5	3	Input
6	3	Return
7	4	Input
8	4	Return
9	+24V	Output
10	+24V	Output
11	+24V Return	Return
12	+24V Return	Return

Near Field Communications (NFC) Tags

NFC tags can be used to automatically fill in the sampling zone and location fields when sampling; they can also be used for entering a User ID. NFC tags must contain an ISO 14443 Type A chipset, also known as Mifare® Classic® Type A. See [NFC](#) settings for more information of programming the tags. To use the tag to enter zone/location or User ID, hold the tag in close proximity to the NFC reader which is located under the AeroTrak™+ Portable Particle Counter label on the front panel; the instrument beeps to indicate the card has been read.

Using an Isokinetic Sample Probe

The isokinetic sample probe (ISP) smoothly accelerates air into the inlet of the instrument when pointed into unidirectional air. This design minimizes the over or under-sampling of larger particles. The ISP directly connects to the instrument or can be used with tubing to monitor particles in remote or hard to reach places.

Specific ISPs are designed to work with the different flow rates available on A100 models: 1 CFM, 50 LPM, and 100 LPM.

Push the ISP firmly over the barbed sample inlet to use. The barbed inlet is isolated from the instrument case and sealed with an O-ring under the flange.



®Mifare and Mifare Classic are registered trademarks of NXP B.V.

(This page intentionally left blank)

CHAPTER 3

Operation

Powering On/Off and Sleep Mode

To power on the instrument, press the **On/Off** button . The instrument is ready for operation when the **Sample Screen** appears.

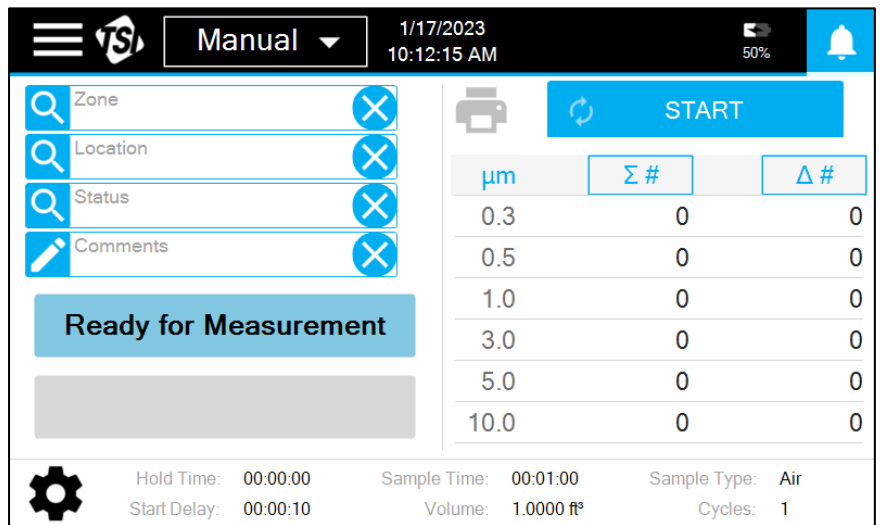

To power off the instrument or enter sleep mode, press the **On/Off** button . A pop-up appears with the options to **SHUTDOWN**, **SLEEP**, or **CANCEL**.

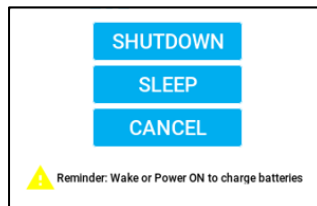

Press **SHUTDOWN** to perform a complete shutdown. Batteries cannot be charged when in a complete shutdown. Press **SLEEP** to enter sleep mode. Sleep mode will turn off instrument components that consume large amounts of energy, like the display. Sleep mode allows for the conservation of battery power with a much shorter startup time. Press the **On/Off** button  to wake from sleep mode; touchscreen may take a few seconds to become responsive when waking from sleep mode.

Using the On-screen Keyboard/Keypad

AeroTrak™+ A100 Portable Airborne Particle Counters are controlled using a touch screen display.

NOTICE

DO NOT use sharp objects (such as a pen point) that may damage the screen overlay.

Some screens require or allow you to enter information. To enter information, tap on the screen and an on-screen keyboard appears.

Software Input Panel (Keyboard or Keypad)

1. A keyboard or keypad appears on the screen for text or number entry.
2. When using the keyboard, if numeric or special character input is needed, select the special character key  to get to the alternate keyboard.

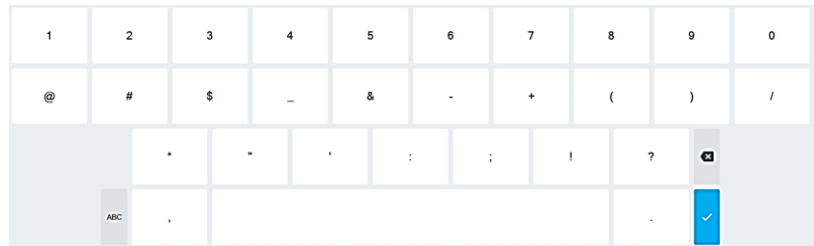

3. Once all information has been entered, press the enter key . The keyboard disappears until another entry box is selected.



Main Status Bar

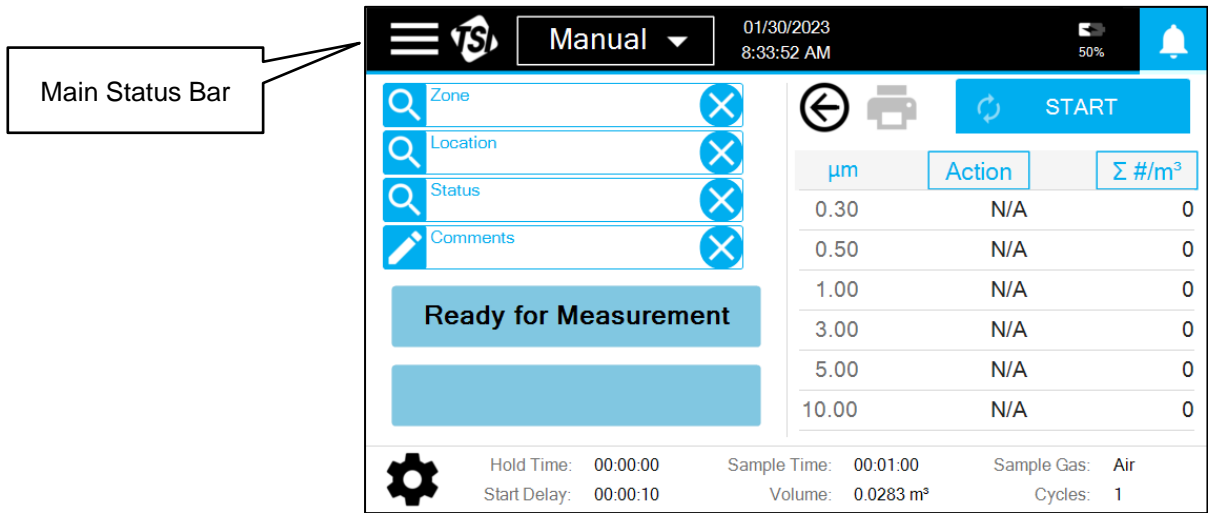

Press the hamburger menu icon  on the upper left corner of the main status bar to access the main menu.

The main menu displays; press the desired menu item to go to that screen:

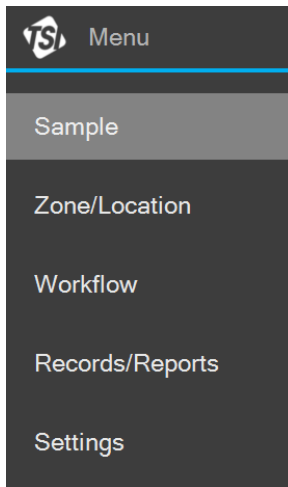

The operation of each of these screens, the information displayed on them, and the operations you can perform from each are described in the remainder of this chapter.

Sampling

Sampling is performed using the **Sample** screen. There are six sample modes. The desired sample mode can be selected from the drop-down in the Main Status Bar:

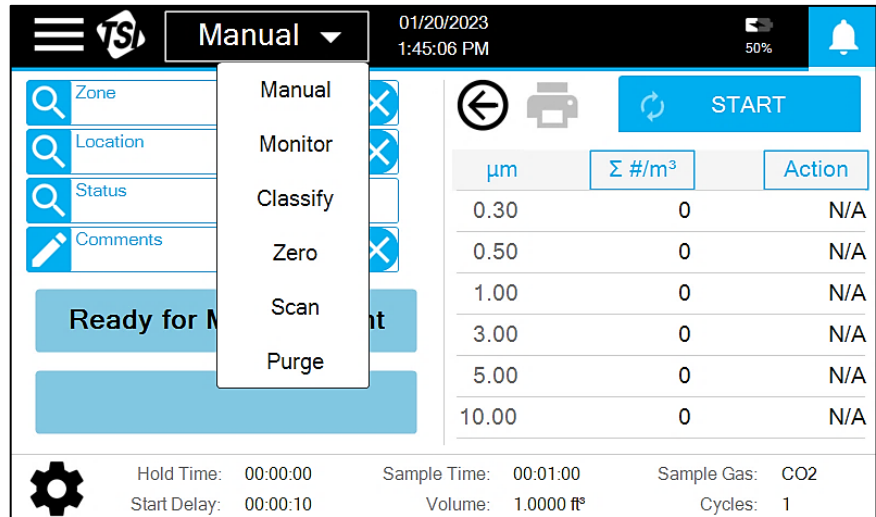

A brief description of each mode is provided in the table below:

Sample Mode	Description
Manual	Quick and easy ad-hoc sampling.
Monitor	Sampling as part of a monitoring program with a set sampling plan and defined alert/action levels.
Classify	Sampling to classify as per international standards or regulatory requirements.
Zero	Sampling HEPA filtered air to ensure that there are no significant counts caused by residual particles in the instrument or tubing (if used).
Scan	Scanning for filter leaks or contamination sources.
Purge	No sampling is performed; instead, a high flow of HEPA filtered air is pulled through the instrument and tubing (if used) to remove residual particles.

With the exception of Purge Mode (which only has a **START** button), the **Sample** screen will appear with the components shown below:

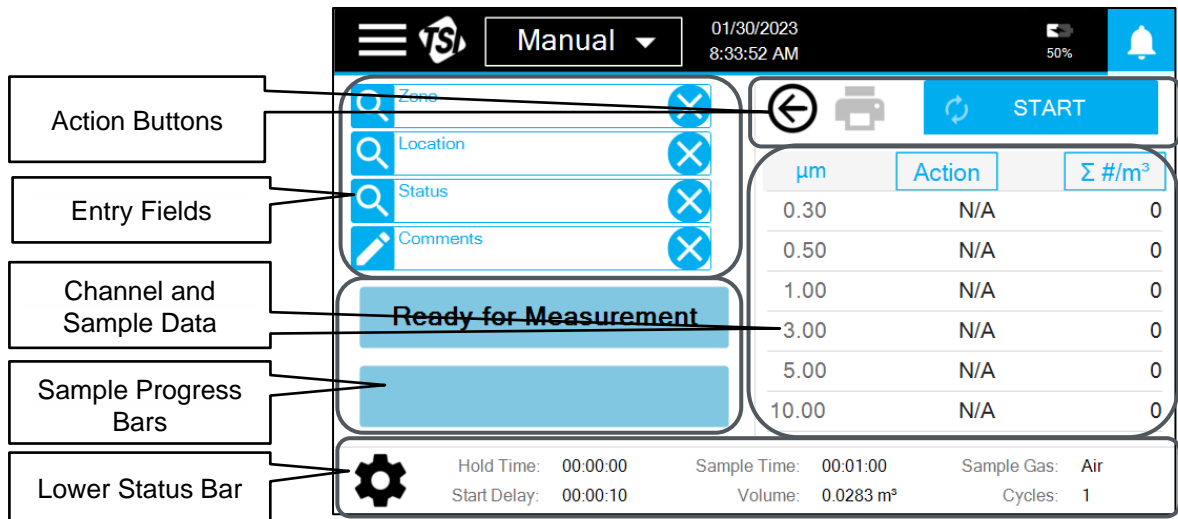

What appears in each of these components will vary by mode, but the general function of each is described in the table below:

Component	Description
Action Buttons	Buttons to perform an action.
Entry Fields	Fields to enter sample metadata.
Channel and Sample Data	Display of sample data and/or limits.
Sample Progress Bars	Indicator of sample progress.
Lower Status Bar	Static indication of the sample parameters; if gear icon is present, provides access to edit the sample parameters.

Sampling Basics

If the **START** button is active, simply pressing the button will start sampling. If the **START** button is not active, sample information must be entered in the entry fields before a sample can be taken. Press the entry field to enter information.

- Zones and Locations are entered by pressing on the entry field and then selecting from the zones and locations in the pop-up box that appears. Zones must be created on the [Zone/Location](#) screen to be available for selection.
- Pressing the **Comments** box opens a text box. The comment entered will be attached to the sample record. If multiple cycles are taken, the comment will appear on all.

NOTICE
Comments can only be entered here prior to sampling; post-sampling comments can be added to a record on the Records/Reports screen.

- To enter information in other fields, press the field and select from the options in the drop-down that appears.

Once the **START** button is pressed, sampling begins per the sample parameters shown in the Lower Status bar. The **START** button becomes the **STOP** button; the **STOP** button can be pressed at any time to abort a sample. The progress of the sample will be indicated by the Sample Progress Bars and particle data and/or limits will be displayed in the Channel and Sample Data table. What is displayed for the Channel and Sample Data is selectable before, during, and after sampling. To change what is displayed, press the button at the top of the column and select the **Units** and **Unit Type** from the drop-downs. To view data from any attached analog sensors, press the arrow button . The Light Bar, if turned on, will indicate that sampling has been started by turning blue and flashing if particles are present.

If limits have been assigned, the applicable data and the alarm bell will be highlighted in yellow if the alert limit is exceeded and red if the action limit is exceeded; an audible alarm also sounds. To mute the audible alarm, press the alarm bell. The Light Bar, if turned on, will turn red if the action level is exceeded. If there is an instrument error, an alert icon  will appear in the Main Status Bar. Press the icon to identify the error.

Once sampling is complete, the **STOP** button becomes the **START** button. The Light Bar, if turned on, will turn green if the action level has not been exceeded or remain red if it did. The sample results can be printed by pressing the **Printer** icon .

In the event of a power failure during sampling, the sample will be marked as an Incomplete Sample in the sample record with a comment of "Power loss detected" added.

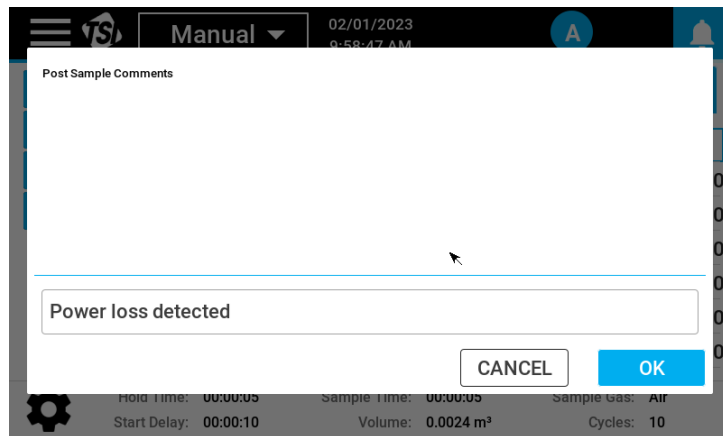

Manual Mode

To sample in Manual mode, press the **START** button and sampling begins per the parameters shown in the Lower Status Bar. To change the sampling parameters, press the gear icon  in the Lower Status Bar. There are three screens of parameters, Timing, Channels & Units, and Limits.

The parameters on the Timing screen are described in table below:

Parameter	Description
Sample Time	The length of time for each sample. Changing the Sample Time automatically updates the Volume.
Start Delay	The length of time before the sample begins.
Hold Time	The length of time between samples.
Volume	The volume of air sampled for each sample. Changing the volume automatically updates the Sample Time.
Cycles	Number of sample cycles taken at each location. Enter a number or use the Continuous switch to select continuous sampling.
Sample Gas	The gas constant for the gas selected will be used to accurately determine sample volume. <div style="text-align: center; border: 1px solid black; padding: 2px;">NOTICE</div> Air is used for ambient or compressed air.

The Channels & Units screen is used to select the particle sizes that will be measured and displayed. Channel sizes are user selectable by pressing the drop-down and selecting from the sizes available. Sizes available for selection are dependent on the other sizes chosen. The sizes can be set to the default by clicking on the **Set to Default Sizes** button. The Units for Limits can be selected from the drop-down.

Alert and Action limits can be entered on the Limits screen. Press the **OK** button to save all changes made or the **Cancel** button to maintain the previous settings.

Monitor and Classify

To sample in Monitor or Classify mode, a Zone and Location must be entered before the **START** button is available. When **Zone** is pressed, a pop-up shows the monitoring zones. Press the desired zone and the available locations will appear. Press the desired location and selected zone and location appears in the entry fields. To continue sampling in the same zone, press **Location** and select the new location.

Zero

Attach the purge/zero filter to the sample inlet prior to sampling. If tubing is to be used for sampling, it is recommended to connect the filter to the end of the tubing. The sample parameters can be updated if needed by pressing the **Gear** icon  in the Lower Status bar. See [Manual Mode](#) for more information on updating parameters.

Scan

Attach the scanning probe to the sample inlet prior to sampling. When scanning, a count is taken every second and no sample records are created. Select the desired Mode, Filter Test, or Investigate. In Filter Mode, a beep sounds each second when particles are detected. In Investigate Mode, one or more beeps sound each second based on what is set in Particles/Beep for the Size selected. The number of beeps is based on the multiple of the number entered. For example, if 10 is entered and 30 particles are counted, there will be three beeps.

Purge

Attach the purge/zero filter to the sample inlet prior to purging. A purge runs for 15 minutes, but can be stopped at any time.

Creating Zones and Locations

Creating and editing zones and locations is performed on the **Zone/Location** screen. There are two Zone Types: Monitor and Classify. There are different configuration options depending on the type chosen. Press the **Add New** icon  to create a new zone.

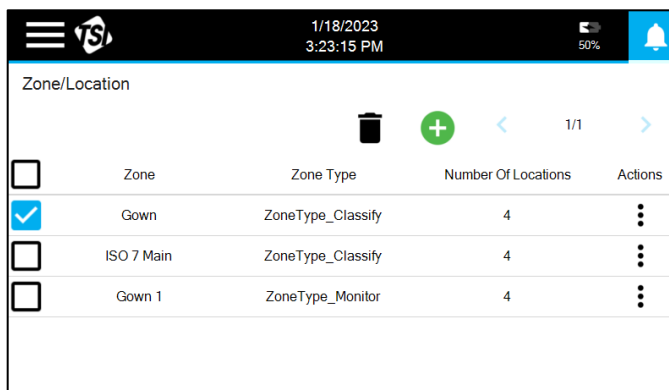

<input type="checkbox"/>	Zone	Zone Type	Number Of Locations	Actions
<input checked="" type="checkbox"/>	Gown	ZoneType_Classify	4	⋮
<input type="checkbox"/>	ISO 7 Main	ZoneType_Classify	4	⋮
<input type="checkbox"/>	Gown 1	ZoneType_Monitor	4	⋮

Create Zone - Monitor

Select **Monitor**, enter a zone name, and press **NEXT**.

Create Zone

Zone Type

Monitor Classify

Zone Name

Enter Zone name

Room 25 Room 100

CANCEL NEXT

There are four screens of parameters: Timing, Channels & Units, Limits: At-Rest, and Limits: Operational. Press on the tabs on the left to go to the different screens.

Edit Zone: Room 5 - Sampling Parameters

Timing

Sample Time 00:01:00 Volume 0.0283 Volume Units m³ ft³

Channels & Units

Start Delay 00:00:10 Cycles 1 Continuous

Limits: At-Rest

Hold Time 00:00:00 Sample Gas Air

CANCEL NEXT

The parameters on the Timing screen are described in detail in [Manual Mode](#). The Channels & Units screen is used to select the particle sizes that will be displayed. The Units for Limits can be selected from the drop-down. Alert and Action limits can be entered for enabled sizes on the Limits: At-Rest and Limits: Operational screens. Press the **NEXT** button to add locations.

To add a location, enter a name in the text field and press the **ADD** button.

Location	Actions
----------	---------

The Location will be added to the list on the right. If locations are to be numbered, start by adding the prefix of the name as a location. That prefix then appears as a button on the left.

Location	Actions
Mfg	X

Press the button with the prefix and it will appear in the text box with a 1 after it. Press the **ADD** button and it will be added to the location list. Repeat and a location 2 will be added.

Location	Actions
Mfg	X
Mfg 1	X

To delete a location, click on the **X** in the **Actions** column. Once all locations have been added, press the **DONE** button.

Create Zone – Classify

Select **Classify**, enter a zone name, and press **NEXT**.

Create Zone

Zone Type

Monitor Classify

Zone Name

Enter Zone name

Room 25 Room 100 Room 5

CANCEL NEXT

Select the standard that will be followed for classification. Standards include ISO 14644-1:2015, EU-Annex 1:2008, EU-Annex 1:2022, and China GMP. The class options will adjust based on the standard selected.

Create Zone: Room 5 - Select Standard

Standard ISO 14644-1:2015

As-Built Class 2

At-Rest Class 2

Operational Class 2

Area 0 Must be > 0

Area Units m² ft²

Considered Particle Sizes

- 0.3
- 0.5
- 1.0
- 3.0
- 5.0
- 10.0

BACK CANCEL NEXT

Select the class(es) for all occupancy states; the enabled Considered Particle Sizes will update to all those specified for the class(es) selected. Disable or enable the desired Considered Particle Sizes. Enter the area of the zone. Press the **NEXT** button.

There are two screens of parameters: Timing and Limits. Press the tabs on the left to go to the different screens.

The parameters on the Timing screen are described in detail in [Manual Mode](#). The sample times and volumes will default to the minimum required per the selected class(es). The limits will autopopulate with the limits for the selected standard. Press the **NEXT** button to add locations.

Refer to [Create Zone – Monitor](#) for detailed information on adding locations. Classify zones also have the option to autopopulate the minimum number of locations for the area of the zone. Pressing the **AUTO** button will number the locations.

Location	Actions
1	X
2	X
3	X
4	X
5	X

A prefix can also be used with the **AUTO** button. Enter the desired prefix and then press the **AUTO** button.

Create Zone: Room 5 - Add Locations

Location	ADD	Location	Actions
	AUTO	Location 1	X
		Location 2	X
		Location 3	X
		Location 4	X
		Location 5	X

BACK CANCEL DONE

The Sample Parameters will prefill with appropriate values. These can be edited if desired.

Editing, Duplicating, or Deleting a Zone

Zones can be edited, duplicated, or deleted by pressing the three dots in the Action column for the desired zone.

01/31/2023
7:47:17 AM

Zone/Location

Zone	Zone Type		Actions
Room 5	Classify		⋮
Room 5	Monitor	2	⋮
Room 100	Monitor	2	⋮
Room 25	Classify	6	⋮
Room 25	Monitor	4	⋮

Context Menu: Edit, Duplicate, Delete

Duplicating a zone will create a new zone with an identical configuration to the selected zone; a new name must be entered.

Using Workflows

Creating workflows is performed on the **Workflow** screen. Using a Workflow allows you to create a set of monitoring locations to assign Sample IDs and manage sampling.

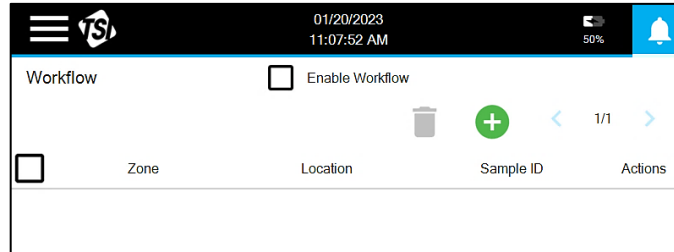

Press the **Add New** icon  to add locations to a workflow. Select a zone from the options available (monitoring zones). Select all the desired locations to be included in the workflow. Repeat the steps above to add locations from other zones.

To add a user assigned Sample ID to a location, press the three dots in the Action column and press **Edit**. Enter the Sample ID and press **SAVE**.

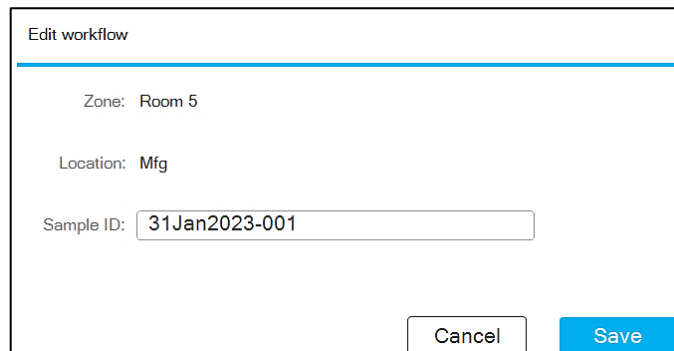

Locations can be removed from the list by either checking the box on the left and pressing the **Delete** icon , or by pressing the three dots in the Action column and pressing **Delete**. To delete all locations, press the box at the top of the column to check all locations and press the **Delete** icon.

To use a workflow, click the **Enable Workflow** box at the top of the screen. With the workflow enabled and sampling in Monitoring mode, only the locations in the workflow will be available to select. Upon start of the workflow, all location buttons will be gray. As samples are taken, the buttons turn green, yellow, or red to indicate that the sample has been taken and if the result was within limits, exceeded the alert limit, or exceeded the action limit.

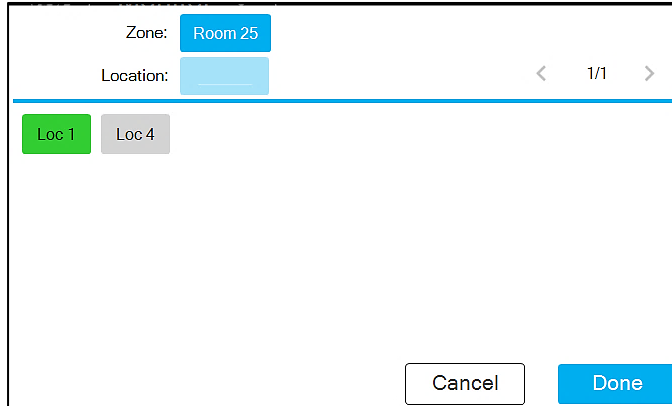

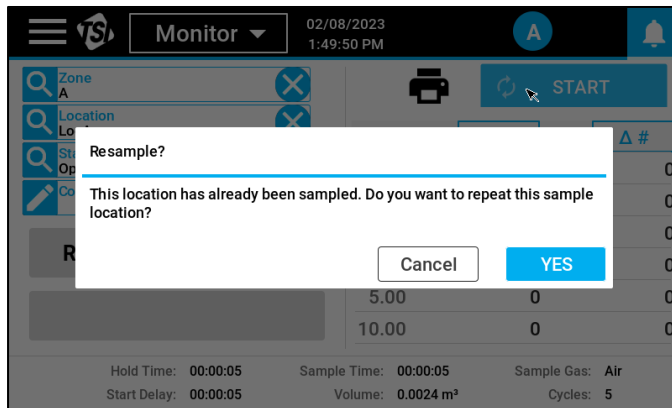

If a location that has been previously tested is selected, a box will appear asking if sampling is to be repeated.

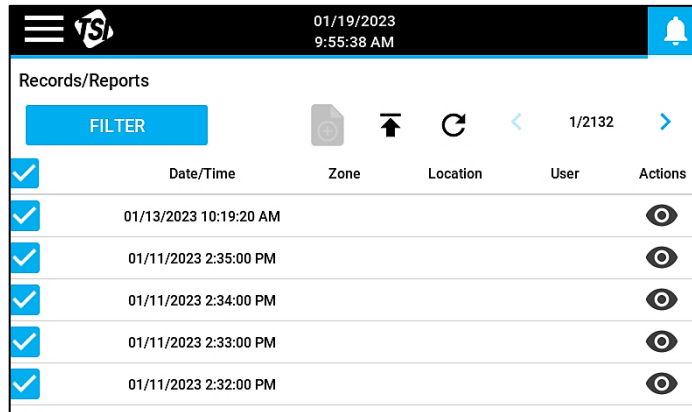

Records and Reports

Data taken by the instrument is stored in the internal memory buffer. A filterable listing of the data records can be found in the **Records/Reports** screen.



Records are listed with the most recent on top. Press the arrow buttons, < 1/2132 >, to scroll through additional pages of records. If actively sampling, press the **Refresh** icon  to refresh the list and add any new records that have completed since the list was previously generated.

Since the instrument can store up to 250,000 records, it is generally useful to filter the list to the records of interest. To filter records, press the **FILTER** button.

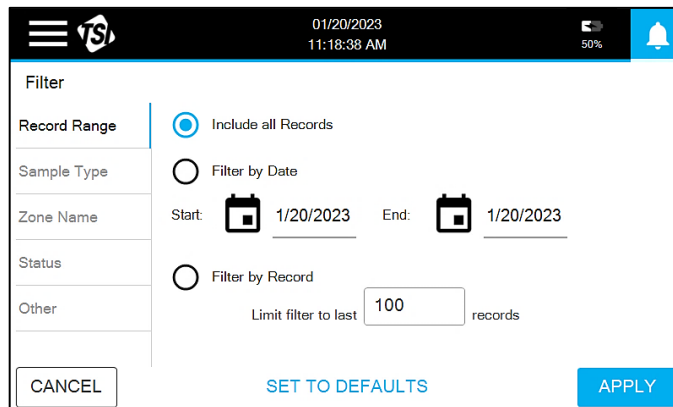

The Filter page has five screens of filtering options: Record Range, Sample Type, Zone Name, Status, and Other. Press on the tabs on the left to go to the different screens. To apply the filter(s), press the **APPLY** button.

Viewing Sample Records

To view a sample record, press the **Eye** icon  in the Action column of the records list.

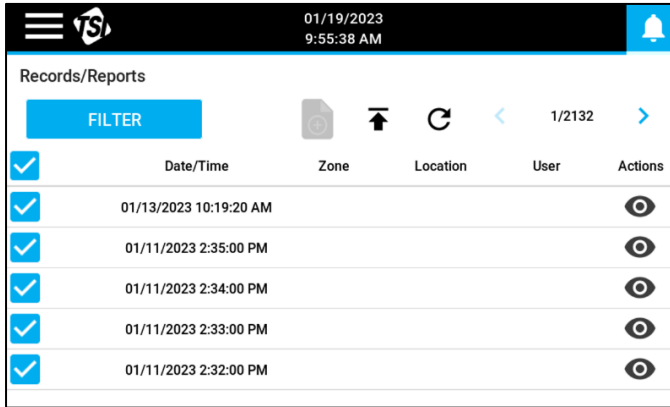





Records/Reports

01/19/2023 9:55:38 AM

FILTER

1/2132

<input checked="" type="checkbox"/>	Date/Time	Zone	Location	User	Actions
<input checked="" type="checkbox"/>	01/13/2023 10:19:20 AM				
<input checked="" type="checkbox"/>	01/11/2023 2:35:00 PM				
<input checked="" type="checkbox"/>	01/11/2023 2:34:00 PM				
<input checked="" type="checkbox"/>	01/11/2023 2:33:00 PM				
<input checked="" type="checkbox"/>	01/11/2023 2:32:00 PM				

Sample metadata is displayed on the left and the results in the table on the right.

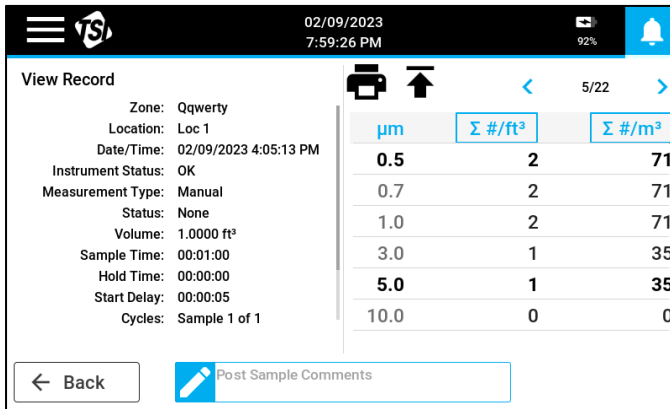

View Record

02/09/2023 7:59:26 PM 92%

Zone: Qqwerty
Location: Loc 1
Date/Time: 02/09/2023 4:05:13 PM
Instrument Status: OK
Measurement Type: Manual
Status: None
Volume: 1.0000 ft³
Sample Time: 00:01:00
Hold Time: 00:00:00
Start Delay: 00:00:05
Cycles: Sample 1 of 1

5/22

μm	$\Sigma \#/\text{ft}^3$	$\Sigma \#/\text{m}^3$
0.5	2	71
0.7	2	71
1.0	2	71
3.0	1	35
5.0	1	35
10.0	0	0

← Back Post Sample Comments

The columns in the results table are selectable by pressing on the box at the top of the column. A comment can be added to the record by entering it in the **Post Sample Comments** field at the bottom of the screen. Press the **Printer** icon  to print the record with the thermal printer. The arrow buttons can be used to scroll through records.

Exporting Sample Records

To export data records in a Secured XML file, insert a USB drive and press the **Export** icon . Select the file type, enter a file name, and press the **Export** button. Only filtered records will be exported.

Report Generation

Preconfigured reports are available for Classify or Monitor records. The report includes only the filtered records. Samples must be all of the type, Classify or Monitor, or the Report icon will be disabled . Filter the records as needed to enable the Report icon. All the filtered records will be included in the report, but any samples that are unchecked, will be excluded for any analysis. To start the report generation process, press the Report icon; Classify records generates a Classification Report and Monitor records generates a Monitoring Report.

If generating a Classification Report, a box appears that allows for editing of the Report Name and indicates the result of the classification for the class that was selected when configuring the zone. For zones configured for classification per the ISO standard, the standard and class can be changed. However, if one of the GMP regulations was selected during configuration, only a report for that standard and class can be generated. Press the **PRINT** button to printout a report on the thermal printer, or, install a USB Drive and press the **EXPORT PDF** button to export a PDF report. The reports will summarize the results and assess if all criteria has been met for the selected standard and class.

If generating a Monitoring Report, a box appears that allows for editing of the Report Name and indicates the result of the monitoring. Press the **PRINT** button to printout a report on the thermal printer, or, install a USB Drive and press the **EXPORT PDF** button to export a PDF report. The reports will summarize the results and identify all alert and action level excursions.

Settings

Instrument configuration is performed on the **Settings** screen.

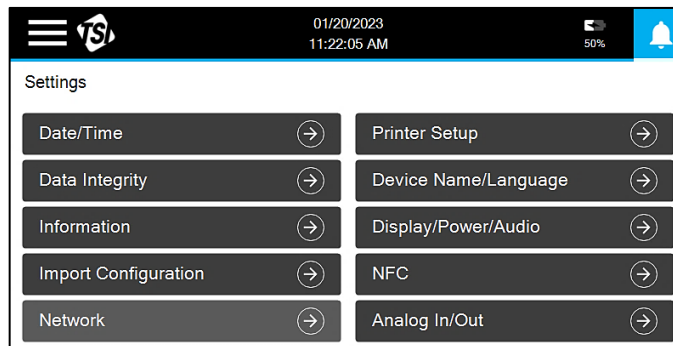

Date/Time

Press the **Date/Time** button to edit the date and time settings.

Date/Time

DATE

1/20/2023

DATE FORMAT

mm/dd/yyyy

TIME

11:24:59 AM AM PM

24 Hour Format

Display UTC Offset

Selected Time Zone: (UTC-06:00) Central Time (US & Canada)

Change Time Zone

CANCEL

Save

A large variety of time zones may be selected. Use the arrows to scroll through the list.

NOTICE

Time will be automatically adjusted for daylight savings based on the selected time zone.

Change Time Zone

Time Zone < 7/21 >

- (UTC-02:00) Coordinated Universal Time-02
- (UTC-02:00) Mid-Atlantic - Old
- (UTC-01:00) Azores
- (UTC-01:00) Cabo Verde Is.
- (UTC) Coordinated Universal Time
- (UTC+00:00) Dublin, Edinburgh, Lisbon, London
- (UTC+00:00) Monrovia, Reykjavik

Cancel Done

Press the **Save** button to save the changes.

Data Integrity

Press the **Data Integrity** button to edit settings to ensure a high level of data integrity through the use of such things as secure logins and the generation of an audit trail.

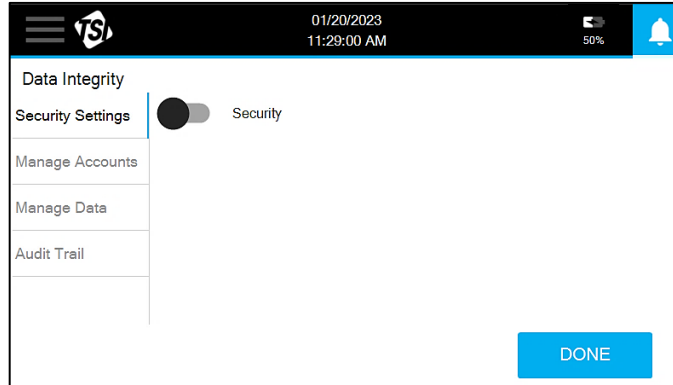

With Security turned off, Manage Accounts will not be active and actions will not be recorded in the audit trail. With Security turned on, Manage Accounts will be active (for Admin users only) and all actions will be recorded in the audit trail. Also, users will be prompted to login to use the instrument and then at times throughout use when a critical action is taken.

Security Settings

Press the Security switch to enable security. A prompt to add a New Account appears if there are no existing users; otherwise, a prompt to login appears.

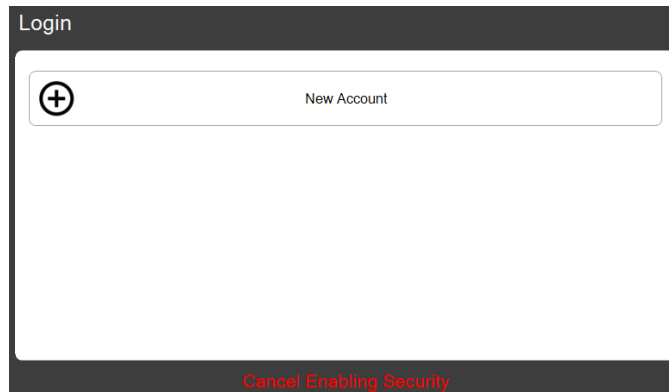

The first account must be an Admin account. Enter an Account Name and Password. A login prompt will appear. Enter the Account Name and Password and press the **Arrow** icon. A prompt to Change Password will appear. Enter a new Password. The new user will now be logged in as indicated by the User icon in the Main Status Bar.

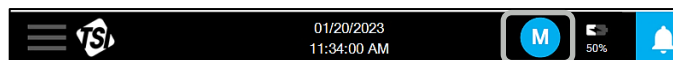

When the Data Integrity button is pressed with Security enabled, additional setting options will appear on the Security Settings screen.

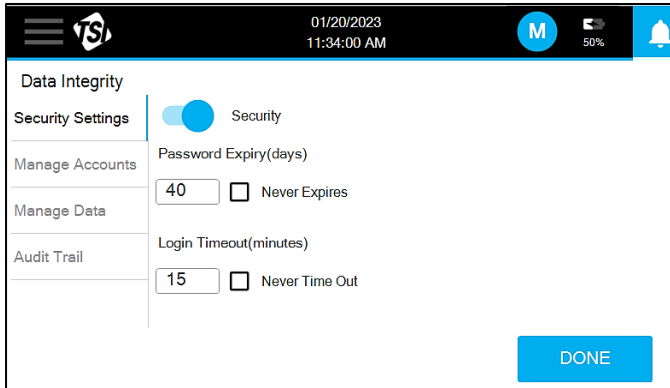

To set any changes to the Password Expiry or Login Timeout settings press the **DONE** button.

Manage Accounts

User accounts are managed in the Manage Accounts screen.

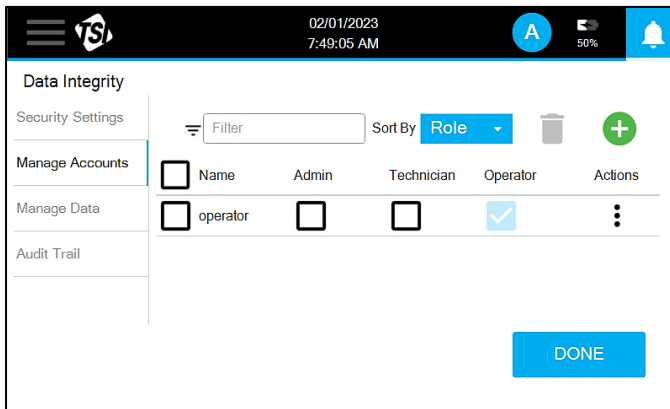

The list of users can be filtered or sorted as needed to find a user or set of users.

To create a new user account, press the **Add New** icon . A Create Account box will appear. Enter an Account Name and Password.

NOTICE
New users will be prompted to update the password on first login.

Select a User Role from the drop-down. There are three roles to choose from: Operator, Technician, and Admin. Users assigned to the Admin role will have access to all functionality; whereas some functionality will not be available to those assigned to Operator and Technician roles. A summary of the permissions for all roles is provided in the following table.

Screen	Description	Operator	Technician	Admin
Sample	Sample in Manual, Monitor, Classify, Zero, Scan, Purge, sampling modes. Program NFC cards.	×	×	×
Zone/Location	Create, delete, edit zones.		×	×
Workflow	Add, delete zone, location and sample ID from workflow. Enable a workflow.	×	×	×
Records/Reports	Export/Print sample Data.		×	×
Settings - Date/Time	Set date, time, time-zone, date/time format, UTC offset display.		×	×
Settings - Data Integrity	Turn on/off security, manage accounts, manage data (delete all data, reset to default).			×
Settings - Device Name/Language	Give the device a name and set language.			×
Settings - Information	View information about the device (serial number, model number, etc., calibration dates, IP addresses, hardware usage time).	×	×	×
Settings - Information	Update the device firmware.			×
Settings - Display/Power/Audio	Set display brightness, buzzer volume and turn light bar on/off.	×	×	×
Settings - Import Configuration	Import a configuration from TrakPro™ Lite Secure Software.	×	×	×
Settings - NFC	Turn on/off NFC reader/writer.			×
Settings - Network	Connect to Wi-Fi® or ethernet.	×	×	×
Settings - Analog In/Out	Configure analog devices/behavior.			×

To update a user role, check the box of the new role. Press the three dots in the Actions column to delete a user or reset the password.

NOTICE
User will be prompted to update password during the next login.

You may also update your own password by pressing the User icon in the Main Status Bar and pressing **Change Password**. This is where you can also logout.

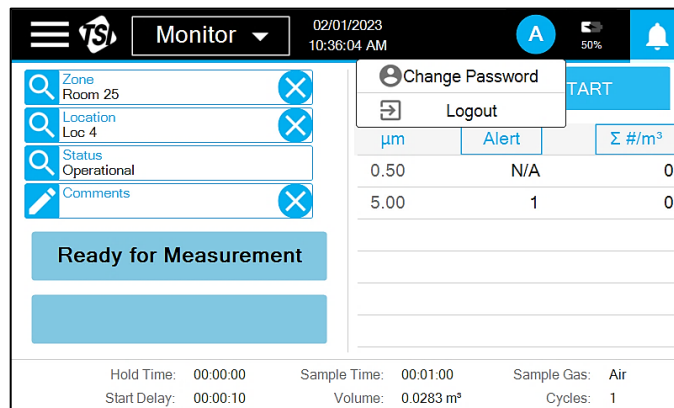

Manage Data

There are two options on the Manage Data screen: Reset to Factory Defaults and Delete all Records.

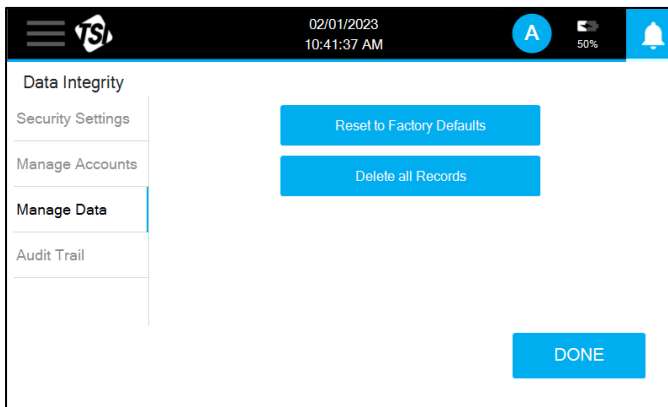

Press the **Delete all Records** button to clear all the sample records in the internal memory buffer; there is no method for selectively deleting data. Pressing the **Reset to Factory Defaults** button resets all instrument configurations to the original defaults; all records must be deleted prior to performing a factory reset. A warning box appears to confirm prior to executing the reset.

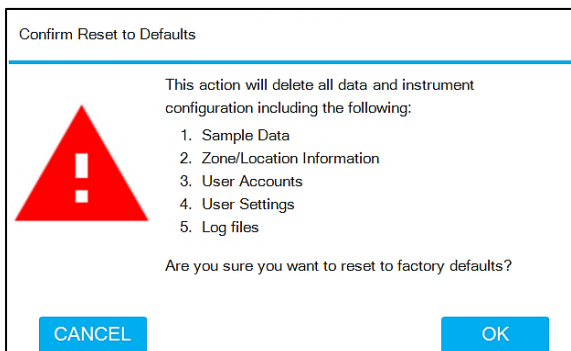

Audit Trails

The audit trail screen lists the actions taken by users. The entries will have the most recent on top. The arrow icons can be used to scroll through the pages. Each entry includes the date and time it occurred, the attributed user, the event type, and any clarifying information.

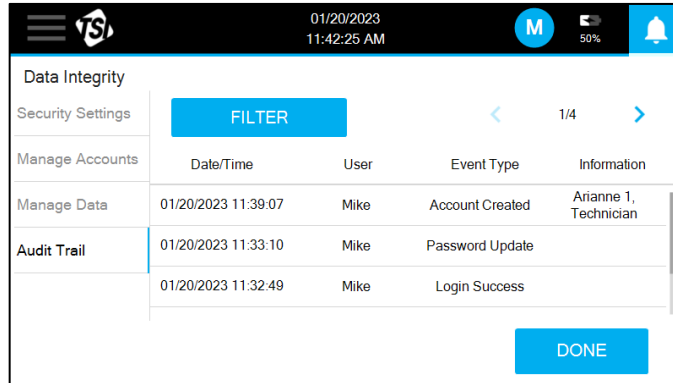

The list can be filtered by Date Range, User, or Event Type by pressing the **FILTER** button.

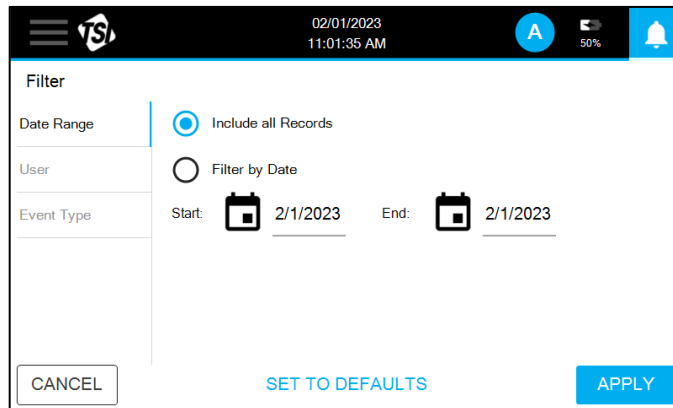

Information

Device-specific information can be found on the Information screen.

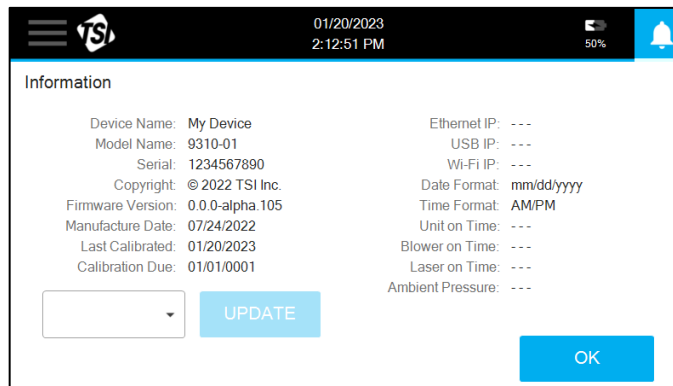

Firmware updates can be performed by inserting a USB drive with updated version of the firmware into the USB port. The list of available versions will appear in the drop-down. Select the desired version and press the **UPDATE** button. Firmware is downloaded from the TSI® website.

Import Configuration

The Instrument Configuration screen is used to import a configuration created using TrakPro™ Lite Secure software. A configuration file can be imported from a USB drive or when connected to TrakPro™ Lite Secure via a USB or ethernet connection. Available files will appear in the drop-down. Select the desired configuration and press the **IMPORT** button.

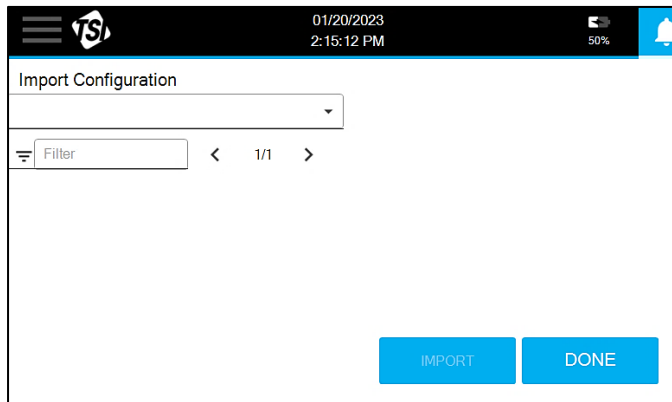

Network

Communication settings can be edited in the Network screen. Settings are available for Ethernet or Wi-Fi® (if the wireless dongle is installed).

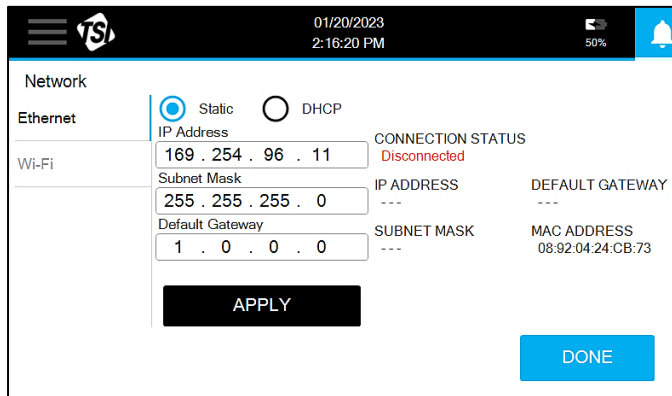

Printer Setup

Settings for printing with the integrated thermal printer are editable in the Printer Setup screen.

Printer Setup

Auto-Print

Auto-Print on Action

CANCEL Save

Turning on **Auto-Print** will automatically print the sample record at the end of sampling. Turning on **Auto-Print on Action** will automatically print the sample record at the end of sampling only if the action limit was exceeded.

Device Name/Language

The language can be selected and a name assigned to the device on the Device Name/Language screen.

Device Name/Language

DEVICE NAME

My Device

LANGUAGE

English

CANCEL Save

Enter the device name and select the language from the drop-down. Press **Save** to apply.

Display/Power/Audio

Settings for the display, power savings, and audio can be changed on the Display/Power/Audio screen.

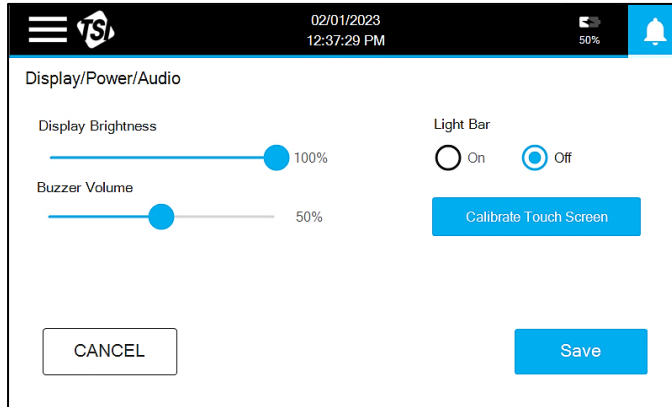

Use the sliders to adjust the Display Brightness and Buzzer Volume. The Light Bar can be turned On or Off. If the touchscreen responsiveness has become poor, it can be calibrated to try to improve performance. Press the **Calibrate Touch Screen** button and follow the prompts.

Near Field Communications

Near Field Communications (NFC) are enabled in the NFC screen. There are switches to turn on and off the use of NFC for User Login and the entry of the Zone and Location.

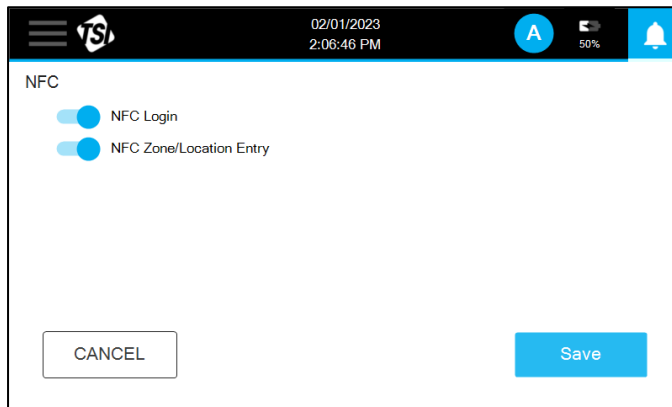
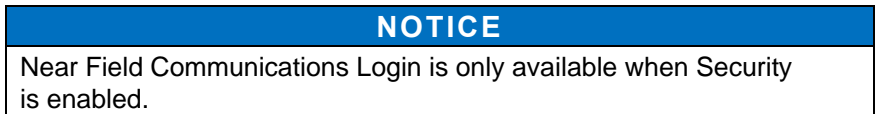

With NFC Zone/Location Entry turned on, an NFC card can be programmed by going the Sample screen in either Monitor or Classify mode. Select a Zone and Location and tap the  icon. A prompt will appear.

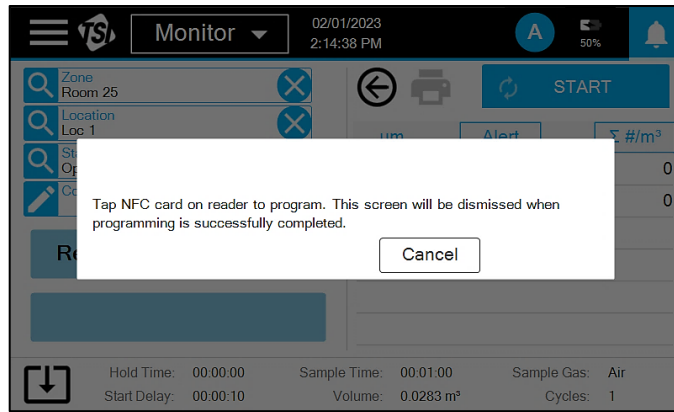

Hold an NFC card near the NFC Reader/Writer. The prompt will be dismissed and a beep will sound to indicate the card has been programmed.

With NFC Login turned on, an NFC card can be programmed by pressing the **User** icon and selecting **Create NFC Login**.

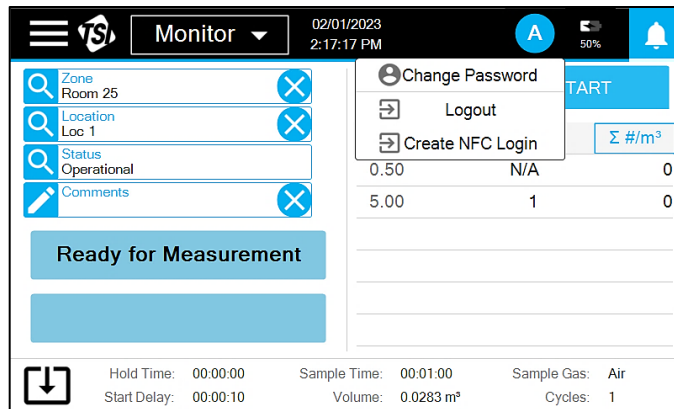

A prompt will appear. Hold an NFC card near the NFC Reader/Writer. The prompt will be dismissed and a beep will sound to indicate the card has been programmed.

To read an NFC card, hold the card near the  icon to populate a zone and location on the Sample screen or to login in a user when prompted to login.

Analog In/Out

Analog inputs, outputs and relays are configured in the Analog In/Out screen. There are three screens: Analog In, Analog Out, and Relay Trigger. However, for non-analog models, only the Relay Trigger screen is present.

Enter information for connected analog sensors in the **Analog In** screen, this includes the name, range, and units.

The screenshot shows the 'Analog In/Out' configuration screen. The top bar includes the TSI logo, date (02/01/2023), time (2:37:19 PM), a user profile icon (A), battery level (50%), and a notification bell. The main content area is titled 'Analog In/Out' and contains a table with four rows. The first row is for 'Analog In', the second for 'Analog Out', and the last two for 'Relay Trigger'. Each row has columns for 'Name', 'Min', 'Max', and 'Unit'. The 'Min' and 'Max' values are set to 4 and 20 respectively for all rows. The 'Unit' column is empty. At the bottom, there are 'CANCEL' and 'Save' buttons.

	Name	Min	Max	Unit
Analog In	1	4	20	
Analog Out	2	4	20	
Relay Trigger	3	4	20	
	4	4	20	

Select the particle size data and scale to be communicated out through the analog outputs on the **Analog Out** screen.

The screenshot shows the 'Analog In/Out' configuration screen, specifically the 'Analog Out' section. The top bar is identical to the previous screenshot. The main content area is titled 'Analog In/Out' and contains a table with three rows. The first row is for 'Analog In', the second for 'Analog Out', and the last for 'Relay Trigger'. Each row has columns for 'Particle Size' and 'Scale'. The 'Particle Size' values are 0.3, 0.5, and 1.0 respectively. The 'Scale' values are all 'Log Scale'. At the bottom, there are 'CANCEL' and 'Save' buttons.

	Particle Size	Scale
Analog In	1 0.3	Log Scale
Analog Out	2 0.5	Log Scale
Relay Trigger	3 1.0	Log Scale

Settings to trigger an external alarm are set on the **Relay Trigger** screen. Turn on the **Action Limit** switch to alarm when an action limit is exceeded. Turn on the **Hardware Limit** switch to alarm when there is an instrument error. A delay can also be set and will apply to all triggers that are turned on.

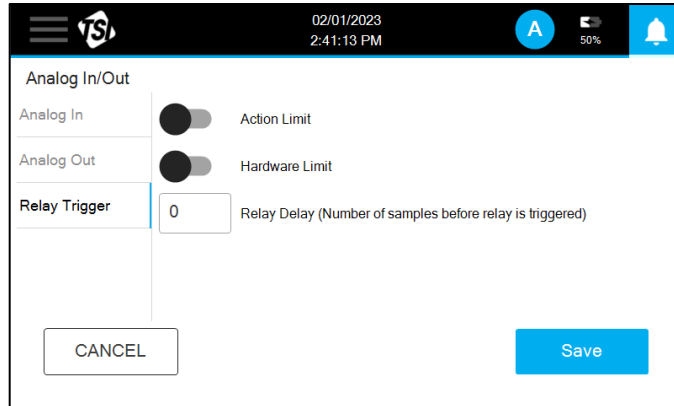

CHAPTER 4

Maintenance

The chapter contains maintenance and troubleshooting solutions for the AeroTrak™+ A100 Portable Airborne Particle Counters.

NOTICE

There are no user-serviceable parts inside this instrument. Opening the instrument case may void the warranty. TSI® recommends that the AeroTrak™+ Airborne Particle Counter be returned to the factory for any required maintenance or service not described in this manual. Cleaning can be done without removing the instrument case.

Maintenance Schedule

TSI® recommends annual factory cleaning and calibration for the AeroTrak™+ Airborne Particle Counter. See [Chapter 6, "Contacting Customer Service"](#) for service/calibration.

Recommended Field Maintenance Schedule

Item	Frequency
Purge and Zero check	Daily or according to application.
Factory cleaning and calibration	Annually.
Cleaning the instrument enclosure	As needed.

Cleaning the Instrument Enclosure

To clean the enclosure, dampen a lint-free cloth with a mild cleaning solution and gently wipe the surface until surface contamination is removed. Ensure that nothing enters the sample inlet during cleaning.

(This page intentionally left blank)

CHAPTER 5

Troubleshooting

Symptom	Possible Cause	Corrective Action
Counts are too low	<p>Instrument is being operated outside temperature or relative humidity specifications.</p> <p>Internal parts have been damaged because instrument was stored at a temperature greater than 158°F (70°C).</p> <p>Instrument has contamination on the optics due to condensation or excessive loading.</p> <p>Laser or pump control is damaged.</p> <p>Unit is due for calibration.</p>	<p>Operate instrument within specifications.</p> <p>Return to factory or factory authorized service centers for service.</p> <p>Return to factory or factory authorized service centers for service.</p> <p>Return to factory or factory authorized service centers for service.</p> <p>Return to factory or factory authorized service centers for service.</p>
Instrument does not turn on	<p>The on/off button is not being pressed properly.</p> <p>Battery is not charged.</p> <p>Power cord is not plugged into unit.</p>	<p>Press and hold the on/off button for one second.</p> <p>Recharge battery or connect to AC power.</p> <p>Connect power cord.</p>
Instrument does not meet zero count specification	<p>HEPA zero filter is not connected properly and room air is leaking into the HEPA zero filter assembly.</p> <p>Residual particles from previous samples are shedding off internal parts and into the optics.</p> <p>An internal component has been damaged due to operation outside of temperature specifications or one or more excessive bumps or jolts, and electronic noise is inducing false counts.</p> <p>A leak has developed in the aerosol flow path.</p> <p>Internal optics have become dirty.</p>	<p>Check that the HEPA zero filter has been tightly connected to the inlet. Check that rubber O-ring (black) on the inlet is in place.</p> <p>Purge instrument by running the instrument for 15 to 30 minutes before attempting zero count test. Longer purge times may be required depending on amount of particle contamination in the instrument.</p> <p>Return to factory or factory authorized service centers for service.</p> <p>Return to factory or factory authorized service centers for service.</p> <p>Return to factory or factory authorized service centers for service.</p>

Symptom	Possible Cause	Corrective Action
Battery does not charge	The unit must be turned on for the battery to charge.	Turn on unit while connected to AC power.
Flow Error	<p>Instrument was unable to control flow rate [i.e., if sample tubing used is too long (greater than 12 m on 28.3 and 50 L/min instruments, 8 m on 100 L/min instrument)].</p> <p>Pressure drop across inlet may be too large.</p> <p>Inlet tubing kinked.</p> <p>Inlet not at ambient pressure.</p>	<p>Restart measurement.</p> <p>Lower pressure drop across inlet by using larger diameter tubing, less tubing, and/or adding a bleed valve.</p> <p>Straighten tubing.</p> <p>DO NOT subject the unit to other than ambient pressure conditions.</p>
Laser Power/Detector Warning	<p>Excessive direct light is entering the aerosol inlet.</p> <p>Optical path blocked.</p> <p>Nozzle is misaligned. Fiber attached on the nozzle tip.</p> <p>Detector board damaged. Laser power is normal.</p>	<p>Remove instrument from direct light.</p> <p>Return to factory for service.</p> <p>Contact TSI® and return to factory.</p> <p>Return to factory or factory authorized service centers for service.</p>
Calibration Corrupt Error	Calibration values have been corrupted.	Return to factory for service.
Ambient Condition Error	Instrument is outside the operating temperature limits.	Return instrument to acceptable operating conditions.

CHAPTER 6

Contacting Customer Service

This chapter gives directions for contacting people at TSI® Incorporated for technical information and directions for returning the AeroTrak™ Portable Airborne Particle Counter for service.

Technical Contacts

- If you have any difficulty setting up or operating the AeroTrak™+ Portable Airborne Particle Counter, or if you have technical or application questions about this system, contact an applications engineer at TSI® Incorporated, 1-800-680-1220 (USA) or (651) 490-2860 or e-mail technical.services@tsi.com.
- If the AeroTrak™+ Portable Airborne Particle Counter, does not operate properly, or if you are returning the instrument for service, visit our website at tsi.com/service, or contact TSI® Customer Service at 1-800-680-1220 (USA) or (651) 490-2860.

International Contacts

Service

TSI Instruments Singapore Pte Ltd

150 Kampong Ampat
#05-05 KA Centre
Singapore 368324

Telephone: +65 6595-6388
Fax: +65 6595-6399
E-mail: tsi-singapore@tsi.com

TSI Instrument (Beijing) Co., Ltd.

Room 504-505 5/F, Block D
Chang'An Mills, South Wuyi Theater Road
Shijingshan District, Beijing, 100043
CHINA

Telephone: +86-10-8219 7688
Fax: +86-10-8219 7699
E-mail: tsibeijing@tsi.com

TSI Instruments Ltd.

Stirling Road
Cressex Business Park
High Wycombe, Buckinghamshire
HP12 3ST
UNITED KINGDOM

Telephone: +44 (0) 149 4 459200

E-mail: tsiuk@tsi.com

Technical Support**TSI Instruments Singapore Pte Ltd**

150 Kampong Ampat
#05-05 KA Centre
Singapore 368324

Telephone: +65 6595-6388

Fax: +65 6595-6399

E-mail: tsi-singapore@tsi.com

TSI Instrument (Beijing) Co., Ltd.

Unit 1201, Pan-Pacific Plaza
No. 12 A, Zhongguancun South Avenue
Haidian District, Beijing, 100181
CHINA

Telephone: +86-10-8219 7688

Fax: +86-10-8219 7699

E-mail: tsibeijing@tsi.com

TSI GmbH

Neuköllner Strasse 4
52068 Aachen
GERMANY

Telephone: +49 241-52303-0

E-mail: tsigmbh@tsi.com

TSI Instruments Ltd.

Stirling Road
Cressex Business Park
High Wycombe, Buckinghamshire
HP12 3ST
UNITED KINGDOM

Telephone: +44 (0) 149 4 459200

E-mail: tsiuk@tsi.com

TSI France Inc.

Hotel technologique
BP 100
Technopôle de Château-Gombert
13382 Marseille cedex 13
FRANCE

Telephone: +33 (0)1 41 19 21 99

E-mail: tsifrance@tsi.com

Returning for Service

Visit our website at [tsi.com/service](https://www.tsi.com/service) and complete the on-line “Service Request” form or call TSI® at 1-800-680-1220 (USA), (651) 490-2860, or 001 651 490-2860 (International) for specific return instructions.

Customer Service will need the following information:

- The instrument model number
- The instrument serial number
- A purchase order number (unless under warranty)
- A billing address
- A shipping address

Use the original packing material to return the instrument to TSI®. If you no longer have the original packing material, seal off any ports to prevent debris from entering the instrument and ensure that the display and the connectors on the instrument front and back panels are protected. This instrument is very fragile and must be packed in a manner appropriate for a precision instrument.

(This page intentionally left blank)

APPENDIX A

Specifications

All specifications meet or exceed ISO 21501-4 and JIS B9921 and are subject to change without notice.

Specification	Description
Channel Sizes	A100-31/31A/35/35A: 0.3 to 10.0 µm (6 user selectable channels) A100-50/50A/51/51A/55/55A: 0.5 to 10.0 µm (6 user selectable channels)
Counting Efficiency	A100-31/31A/35/35A: 50% @ 0.3 µm; 100% for particles >0.45 µm (per JIS and ISO 21501-4) ² A100-50/50A/51/51A/55/55A: 50% @ 0.5 µm; 100% for particles >0.75 µm (per JIS and ISO 21501-4) ¹
Concentration Limits	3,900,000 particle/ft ³ at 10% coincidence loss (all models)
Light Source	Long life laser diode
Zero Count Level	<1 count/15 minutes (meets JIS B9921 and ISO 21501-4)
Flow Rate	A100-31/31A/51/51A: 28.3 L/min (1.0 CFM) with ±5% accuracy (meets JIS and ISO 21501-4) A100-35/35A/55/55A: 50 L/min (1.77 CFM) with ±5% accuracy (meets JIS and ISO 21501-4) A100-50/50A: 100 L/min (3.53 CFM) with ±5% accuracy (meets JIS and ISO 21501-4)
Flow Control	Automatic
Calibration	NIST traceable, ISO 21501-4 compliant
Sample Probe/Tubing	Isokinetic sampling probe
Sampling Modes	Manual, Monitor, Classify, Zero, Purge, Scan, Cumulative/Differential Count, Concentration
Sampling Time	1 second to 24 hours, plus Continuous mode
Sample Output	Internal HEPA filter
Vacuum Source	Internal pump with flow control technology and automatic manifold detection
Communication Mode	Modbus [®] TCP over Ethernet (TCP/IP), Wireless, or USB output. NFC programming and reading capable.
Data Storage	250,000 sample records
Data Security	Password protected with 3-tier user role system (when enabled)
Alarm/Status	Audible alarm sounds and LED light bar indication for counts over user-settable threshold values.
Analog Alarm Output	This connector provides two pins for a contact closure to control an external alarm. The contact closure is normally open and rated for 0 to 60 V AC/DC at 1.5 A peak, 0.5 A continuous. The “alarm out” is rated for 60 V insulation. The contact is closed under alarm conditions determined by the programming of the device.

²Meets all ISO 21501-4 specifications for ISO 14644-1 Class 3 and higher cleanrooms

Specification	Description
Display	WVGA 7-inch color touch screen
Languages	English, French, German, Italian, Polish, Portuguese, Spanish, Chinese (simplified), Japanese, Korean
Reports	ISO 14644-1, EU GMP & China GMP reports can be printed or exported to secure PDF
Printer	Built-in thermal printer
External Surface	Stainless Steel
AC Power (power to AC adapter) ...	100 – 240 VAC, 50 – 60 Hz, 1.5A Max Mains supply voltage fluctuations not exceeding $\pm 10\%$ of rated voltage
Transient over-Voltage	According to category II
DC Power (power to instrument)	24 VDC @ 5.0 Amps
Battery	Removable/rechargeable Li-Ion (up to 2)
Battery Life (1 battery)	A100-31/31A/51/51A: >5 hours of continuous use A100-35/35A/55/55A: >3 hours of continuous use A100-50/50A: >1.5 hours of continuous use
Battery Life (2 batteries)	A100-31/31A/51/51A: >10 hours of continuous use A100-35/35A/55/55A: >6 hours of continuous use A100-50/50A: >3 hours of continuous use
Dimensions (L x W x H)	22.6 x 25.0 x 22.2 cm (8.9 x 9.8 x 8.7 in)
Standards	CE, JIS B 9921, ISO 21501-4 as listed above
Weight	4.8 kg (10.5 lbs.) with battery, 4.3 kg (9.5 lbs.) without battery 5.2 kg (11.5 lbs.) with two batteries
NFC Frequency	13.56 MHz
IP Rating	IP20
Pollution	Degree 2
Operation	Indoor Use
Altitude	3000 m
Warranty	2 years workmanship/5 years laser. Extended warranties available.
Operating Conditions	1°C to 35°C (34°F to 95°F); 5% to 95% non-condensing relative humidity
Storage Conditions	-40°C to 70°C (-40°F to 158°F); Up to 98% non-condensing relative humidity
Included Accessories	Power cord, battery, isokinetic probe, 3 m (10 ft) tubing, purge filter, USB cable, alarm connector, wireless (Wi-Fi®) dongle. Operation Manual, Quick Start Guide, and TrakPro™ Lite Secure software available for free download.
Optional Accessories	Electronic filter scanning probe, basic filter scanning probe, additional battery, dual-port external battery charger, printer paper, isokinetic probes, sample tubing, NFC tags, shipping case

Compliance

CE Marking	EN61326-1 / EN 55011, Class A: Radiated Emissions EN61326-1 / EN 55011, Class A: Conducted Emissions EN61000-3-2: Harmonics EN61000-3-3: Voltage Fluctuations EN61000-4-2: Electrostatic Discharge Immunity EN61000-4-3: Electromagnetic Field Immunity (10V/m) EN61000-4-4: Burst Immunity EN61000-4-6: Conducted PS Immunity EN61000-4-5: Surge Immunity EN61000-4-8: Rated Power-Frequency Field Immunity EN61000-4-11: Voltage Dips\Short Interruptions Immunity
RoHS Marking ..	Yes
Laser Safety	Class I laser Wavelength: 660 nm Power: 210 mW Complies with IEC 60825-1, 3rd edition, 2014 Complies with 21 CFR 1040.10 and 1040.11
Other Marking ..	Complies with IMDA Standards, DA104328 เครื่องโทรคมนาคมและอุปกรณ์นี้ มีความสอดคล้องตามมาตรฐานหรือข้อกำหนดทางเทคนิคของ กสทช.
Hong Kong Certification	<div style="border: 1px solid black; padding: 5px; text-align: center;"> <p>Certified for use in Hong Kong 經驗證可在香港使用</p> <p>Certificate No. 證書號碼 HK0012302866</p> </div> <div style="text-align: center; margin-top: 10px;">  <p>通訊事務管理局 COMMUNICATIONS AUTHORITY</p> </div>

Dimensional Diagram

Dimensions are given in millimeters with inch equivalents in parenthesis.

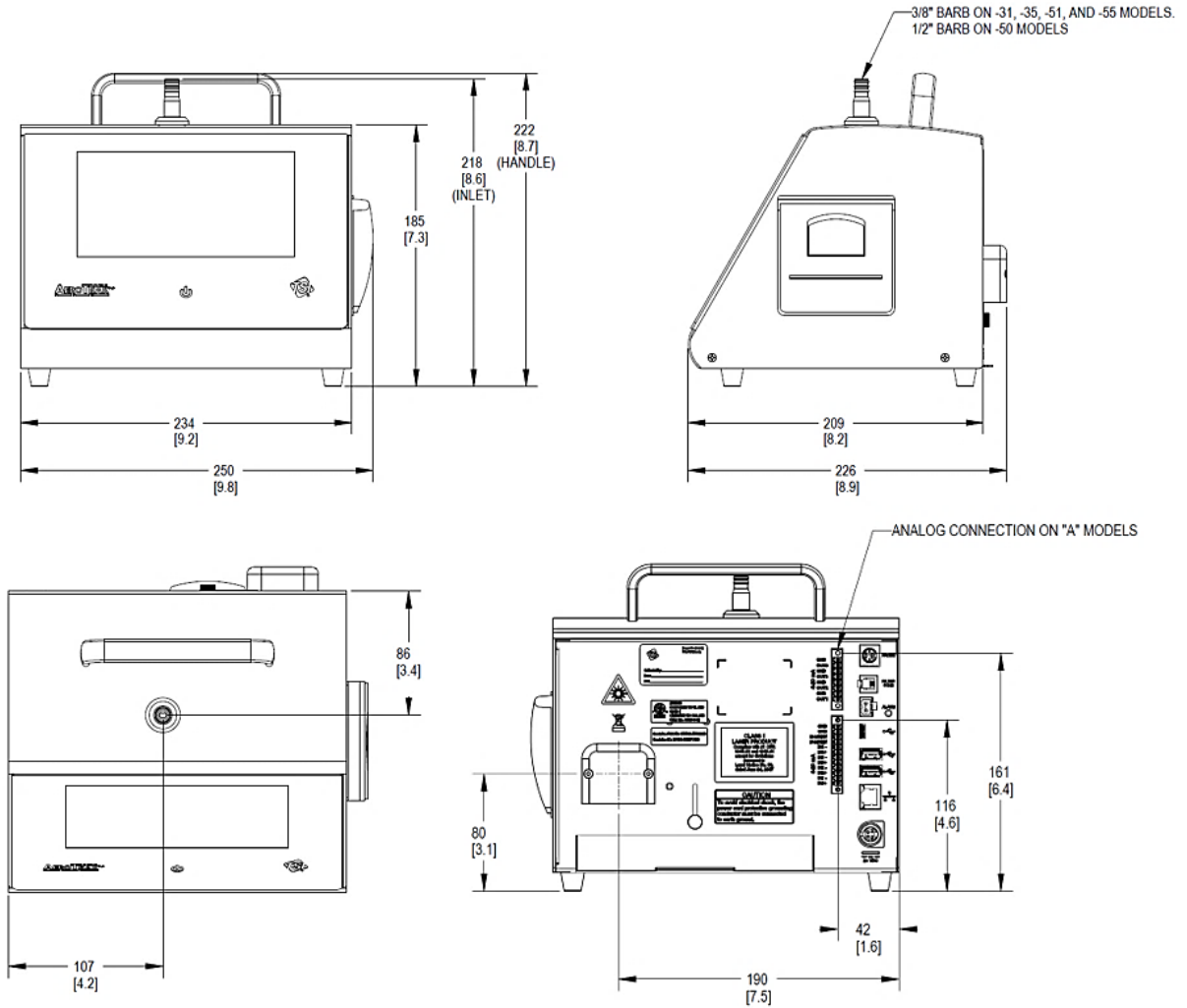



Knowledge Beyond Measure.

TSI Incorporated – Visit our website www.tsi.com for more information.

USA	Tel: +1 800 680 1220	India	Tel: +91 80 67877200
UK	Tel: +44 149 4 459200	China	Tel: +86 10 8219 7688
France	Tel: +33 1 41 19 21 99	Singapore	Tel: +65 6595 6388
Germany	Tel: +49 241 523030		

