

Operating Instructions

PMA Evolution | PMA HD

EVO1S | SPO1S
Paint-mixing Scale



98648-020-40



SARTORIUS

Contents

1 About This Document	4	7 Care and Maintenance	29
1.1 Scope.....	4	7.1 Cleaning.....	29
1.2 Symbols Used.....	4	7.2 Maintenance.....	29
1.3 User Information.....	4	8 Malfunctions	30
2 Safety	5	9 Storage	31
2.1 General Safety Instructions.....	5	10 Recycling	31
2.2 Installation Instructions.....	5	11 Technical Data	32
2.3 Intended Use.....	6	11.1 General Data.....	32
3 Device Overview	7	11.2 Model-specific Data.....	33
3.1 Front View.....	7	11.3 Verified Models with EC Type Approval Certificate: Model-specific Specifications.....	33
3.2 Rear View.....	8	11.4 Geräteabmessungen.....	34
3.3 Operating and Display Elements.....	9	11.4.1 Modell EVO1S.....	34
3.4 Menu List.....	11	11.4.2 Modell SPO1S.....	34
4 Installation	15	11.5 USB Interface (PC Port).....	34
4.1 Unpacking and Equipment Supplied.....	15	11.5.1 Purpose.....	34
4.2 Selecting a Setup Location.....	15	11.5.2 Installing the Software Driver (Windows Update).....	35
4.3 Installing the Scale.....	16	11.5.3 Installing the Software Driver (via CD).....	35
4.4 Supply Voltage.....	16	11.5.4 Installation Instructions for Windows XP® and Above.....	35
4.4.1 Power Supply Assembly.....	16	12 Accessories	36
4.4.2 Connecting the Scale.....	18	13 Sartorius Service	36
4.5 Anti-theft Locking Device.....	18	14 Conformity & Licenses	37
5 Commissioning	19	14.1 EU Declaration of Conformity.....	37
5.1 Leveling.....	19		
5.2 Warm-up Time.....	19		
6 Operation	20		
6.1 Switching the Device On/Off.....	20		
6.2 Locking the Keypad/Weight Display.....	20		
6.3 Zeroing/Taring.....	20		
6.4 Calibration/Adjustment.....	20		
6.4.1 Calibration.....	21		
6.5 Weighing.....	21		
6.5.1 Weighing with One Decimal Place.....	21		
6.5.2 Weighing with Two Decimal Places (Not for Verified Models).....	22		
6.6 Applications.....	22		
6.6.1 Calculation by a Factor.....	23		
6.6.2 Weighing Using the Recalculation Function.....	23		
6.7 Menu Settings.....	25		
6.7.1 Accessing the SETUP Menu.....	25		
6.7.2 Configuring the Main Menu Settings.....	25		
6.7.2.1 Accessing the Setup Menu.....	25		
6.7.2.2 Language Setting.....	26		
6.7.2.3 Standard Default Settings (0.1 g)/ Polyrange (0.05 g/0.1 g) and Grams/Parts per Pound (Not for Verified Models).....	26		
6.7.2.4 Activating the Toggle Key (Not for Verified Models).....	26		
6.7.2.5 Activating the "LOCK" Function 	27		
6.7.2.6 Password Prompt.....	27		
6.7.2.7 Resetting the Scale: "RESET".....	28		

1 About This Document

1.1 Scope

These operating instructions apply to color-mixing scale models:

- EVO1S
- SP01S

1.2 Symbols Used

Denoting instructions and direct hazard warnings, all especially important statements to be observed in these installation instructions will be marked as follows:



This symbol denotes a possible danger with medium risk of death or (severe) injury if not avoided.



This symbol denotes a possible danger with a low risk of moderate or minor injury if not avoided.



This symbol denotes a danger with low risk that could result in property damage if it is not avoided.



This symbol

- is an indication of a function or setting on the device
- indicates that caution should be exercised while working
- identifies useful information.



This symbol provides information for the sale of scales verified for use in legal metrology. In the following, the term "verified" is used to mean "verified for use in legal metrology" or "conformity-assessed."

The following symbols are also used:

- Text that follows this symbol is a list.
- ▶ Text that follows this symbol describes activities which are to be performed in the specified order.
- ▷ Text that follows this symbol describes the result of an action.

1.3 User Information

The illustrations in these instructions are based on the PMA Evolution (EVO1S) model.

2 Safety

2.1 General Safety Instructions

- This scale corresponds to the relevant EU Directives and standards (see Chapter "11 Technical Data," page 32). Incorrect use can lead to injury to persons and material damage. Any installation work or scale operation that does not conform to the instructions will result in forfeiture of all claims under the manufacturer's warranty.
- Read the instructions carefully and completely before operating the device for the first time. Observe the safety instructions in particular.
- In the event of use in systems and ambient conditions which have greater safety requirements, you must observe the requirements and provisions applicable in your country.
- Always keep the equipment and scale freely accessible.



Danger of explosion!

Do not use this equipment in hazardous areas in which explosive materials are present.



Ensure that the voltage rating printed on the AC adapter is identical to your local mains voltage.

2.2 Installation Instructions



Do not operate the scale if its housing, AC adapter, or any connections are damaged. Immediately disconnect the damaged device from the power by pulling the plug.



Do not expose the scale, the AC adapter or the accessories supplied by Sartorius to extreme temperatures, aggressive chemical vapors, moisture, shocks, vibrations, or strong electromagnetic fields. Observe the conditions of operation described in the Specifications.



Installation Information

The operator shall be solely responsible for any modifications to the equipment and for connecting any cables or equipment not supplied by Sartorius.

Information on operational quality is available upon request from Sartorius.
Only use original Sartorius accessories!



Note the IP protection class of the scale and the AC adapter. Do not allow liquid penetration. The protection class specifies the suitability of equipment for various environmental conditions (moisture, foreign bodies).



Before cleaning the AC adapter or the scale: Unplug from the mains power.



The scale may only be opened by specialized personnel trained by Sartorius. Do not open the AC adapter.

Warning regarding installation and during operation:

Lay the cables where they pose no risk of causing someone to trip.

**Danger of Scale Damage!**

Never close a paint can using a hammer while it is still on the weighing pan. When closing, place the paint can on a firm, stable surface.

Observe the additional safety precautions and hazard warnings in subsequent chapters.

2.3 Intended Use

This scale is only intended for mixing colors and paints outside of potentially explosive atmospheres. Appropriate containers must be used for loading each type of material.

The scale can be operated via the keypad as a stand-alone device or using application software (e.g., a paint-mixing program from a paint manufacturer) installed on a connected PC.

3 Device Overview

3.1 Front View

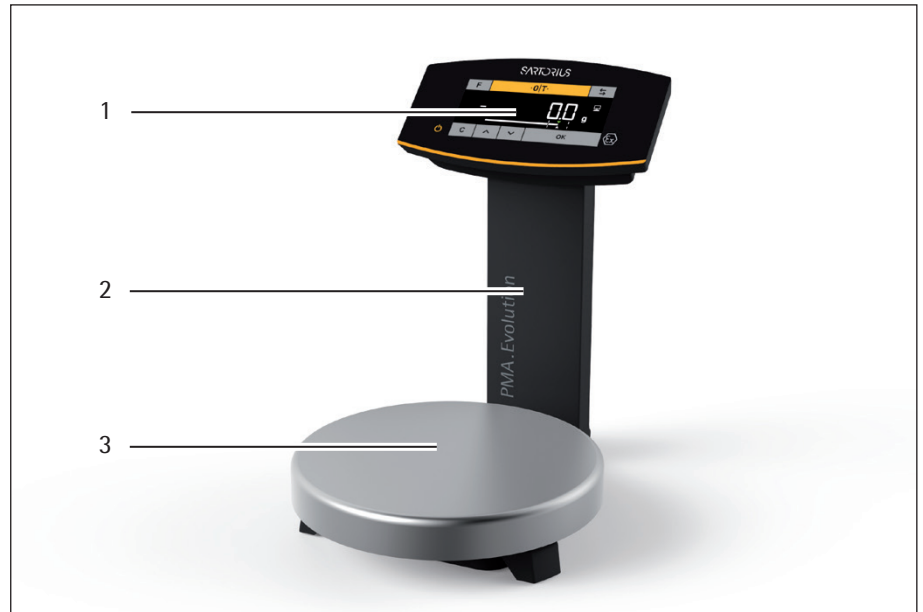

Item	Name
------	------

1	Operating and display elements (see also Chapter 3.3, page 9)
---	---------------------------------------------------------------

2	Support column
---	----------------

3	Weighing pan
---	--------------

3.2 Rear View

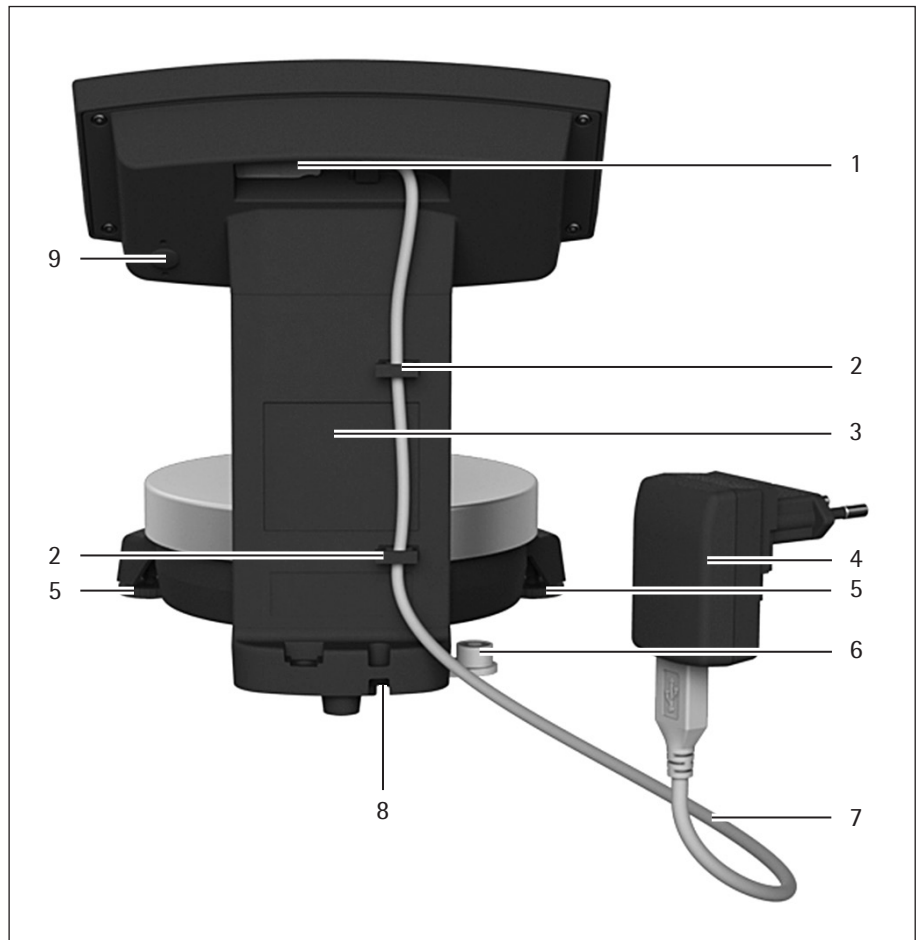

Item	Name
1	USB port
2	Cable holders
3	Support column
4	AC adapter with country-specific mains adapter (optional) (Figure may deviate from product)
5	Leveling feet (PMA HD and verified models only)
6	Leveling (PMA HD and verified models only)
7	USB connection cable
8	Anti-theft locking device
9	Menu access switch

3.3 Operating and Display Elements



Sharp or pointed instruments (such as ballpoint pens) can damage the device!

- The touch screen should only be operated by lightly pressing it using the tips of your fingers.

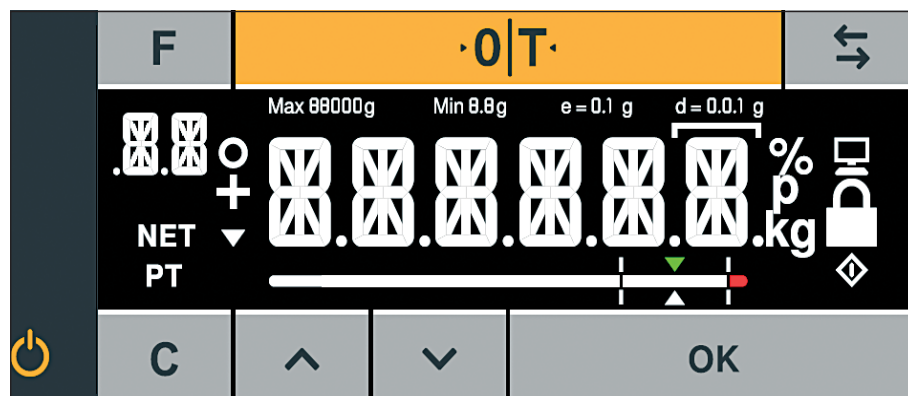

Button Function

Button	Function
F	Factor key for paint-mixing applications
·0 T·	Zeroing/taring
↔	Toggle key: Toggles the decimal places and/or unit Depends on the menu setting
⏻	On/standby
C	Clear key/display of correction factor for paint-mixing applications
^	Up
v	Down
OK	ENTER key/MEM key for paint-mixing applications

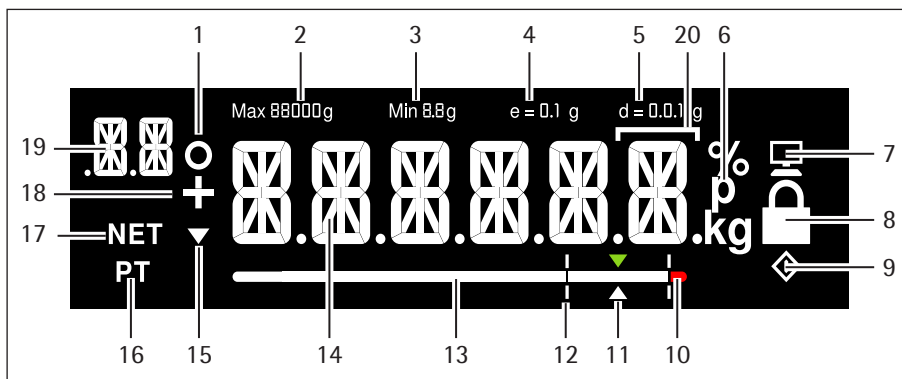

Item	Function
1	Activated function in the menu list (see Chapter 3.4, page 11) Symbols for zero range (verified models only)
2	Maximum weighing range
3	Minimum load Min (verified models only)
4	Verification scale interval e (verified models only)
5	Readability of the scale (scale interval d)
6	Weight unit and stability indicator
7	Communication with the PC
8	Activate "LOCK" function, or function activated
9	◆ symbol: Indicates that an internal process is in progress For verified models: indicates an invalid weight value
10	Tolerance range has been exceeded
11	Target value for bar graph
12	Tolerance range
13	Bar graph: scaled display showing capacity usage (in percent)
14	Fourteen segment display
15	Trend display
16	Info on weight entry via application keypad (preset tare)
17	Net value
18	Plus (or minus) sign of the weight
19	Display: - SETUP level - Component/factor for paint-mixing applications
20	In verified mode for devices where $e \neq d$: The frame indicates a scale interval (standard scale interval d is smaller than verification scale interval e)

3.4 Menu List

The "o" in the active column indicates the activated function in the respective menu.

Level 1	Level 2	Level 3	Active	Level 4	Function	CODE
SETUP						1.
	-----	SCALE				1.1
		----			Installation site	1.1.1
				V.STABL.	Very stable ambient conditions	1.1.1.1
			o	STABLE	Stable ambient conditions	1.1.1.2
				UNSTAB.	Unstable ambient conditions	1.1.1.3
				V.UNSTAB.	Very unstable ambient conditions	1.1.1.4
		----			Application filter	1.1.2
				FIN.RD.	Final readout	1.1.2.1
			o	FILL.WT.	Filling weight	1.1.2.2
		----			Stability range/stability	1.1.3
				1/2-DIG.	1/2 digit/good	1.1.3.2
				1-DIG.	1 digit/normal	1.1.3.3
			o	2-DIG.	2 digits/sufficient	1.1.3.4
				4-DIG.	4 digits/low	1.1.3.5
		----			Automatic zero/drift correction	1.1.6
				ON	On	1.1.6.1
			o	OFF	Off	1.1.6.2
		----			Weight units	1.1.7
			o	GRAMS	Grams	1.1.7.2
				PT.P.LB	Parts per pound ¹⁾	1.1.7.14
		----			Accuracy ¹⁾	1.1.8
			o	ALL	Show all decimal places	1.1.8.1
				POLYR.	Multi-interval lab	1.1.8.13
		----			Calibration/adjustment	1.1.9
			o	CAL.EXT.	External calibration/adjustment with default weight	1.1.9.1
				LIN.EXT.	External linearization with default weight	1.1.9.6
				LOCKED	CAL key/command locked	1.1.9.10
		APP.PRG.				1.3
		----			2nd unit ¹⁾	1.3.1
			o	GRAMS	Grams	1.3.1.2
				PT.P.LB	Parts per pound	1.3.1.14
		----			Accuracy 2nd unit ¹⁾	1.3.2
				ALL	Show all decimal places	1.3.2.1
			o	POLYR.	Multi-interval lab	1.3.2.13
		----			Toggle key on/off ¹⁾	1.3.3
				ON	Toggle key on	1.3.3.1
			o	OFF	Toggle key off	1.3.3.2

Continued on next page

¹⁾ Not available on scales verified for use in legal metrology

Level 1	Level 2	Level 3	Active	Level 4	Function	CODE
{SETUP}	---	REC.MOD.			Recalculation	1.3.4
		----		TOTAL	Gross weight	1.3.4.1
		----	o	INDIV.	Individual	1.3.4.2
	GEN.SRV.					1.9
	---	MEN.RES.			Menu reset	1.9.1
		----		DEFAULT.	Load default menu	1.9.1.1
		----	o	NO	Stand-by	1.9.1.2
DEVICE						2.
	----	EXTRAS				2.1
		---			Menu	2.1.1
		----	o	ENABLE	Menu can be edited	2.1.1.1
		----		RD.ONLY.	Menu read only	2.1.1.2
		---			Key function enabled/locked	2.1.3
		----	o	ENABLE	Keypad enabled	2.1.3.1
		----		LOCKED	Keypad locked	2.1.3.2
		---			Background light	2.1.4
		----		10 PCT.		2.1.4.1
		----		20 PCT.		2.1.4.2
		----		30 PCT.		2.1.4.3
		----		40 PCT.		2.1.4.4
		----		50 PCT.		2.1.4.5
		----	o	60 PCT.		2.1.4.6
		----		70 PCT.		2.1.4.7
		----		80 PCT.		2.1.4.8
		----		90 PCT.		2.1.4.9
		----		100 PCT.		2.1.4.10
		---			Bar graph on/off	2.1.5
		----		OFF	Display without bar graph	2.1.5.1
		----	o	ON	Display with bar graph	2.1.5.2
		---			Switch-on behavior	2.1.6
		----	o	ON/STB.	On/standby	2.1.6.3
		----		AUTO.ON	Automatic on	2.1.6.4
		---			Lock weight display	2.1.9
		----	o	OFF	Display on	2.1.9.1
		----		ON	Display off	2.1.9.2
		---			Bar graph mode	2.1.10
		----	o	NORMAL	Normal width	2.1.10.1
		----		WIDE	Extra wide	2.1.10.2

Continued on next page

Level 1	Level 2	Level 3	Active	Level 4	Function	CODE
<DEVICE>	INTERF.					2.2
	---	PROT.			Data transfer protocol	2.2.1
		----	o	SBI	SBI protocol	2.2.1.1
		----		XBPI	XBPI protocol	2.2.1.2
	---	BAUD			Baud rate	2.2.2
		----		600	600 baud	2.2.2.3
		----		1200	1200 baud	2.2.2.4
		----	o	2400	2400 baud	2.2.2.5
		----		4800	4800 baud	2.2.2.6
		----		9600	9600 baud	2.2.2.7
		----		19200	19200 baud	2.2.2.8
		----		38400	38400 baud	2.2.2.9
		----		57600	57600 baud	2.2.2.10
	---	PARITY			Parity bit	2.2.3
		----	o	ODD	Odd	2.2.3.3
		----		EVEN	Even	2.2.3.4
		----		NONE	No parity check	2.2.3.5
	---	STOPBT.			Number of stop bits	2.2.4
		----	o	1 BIT		2.2.4.1
		----		2 BITS		2.2.4.2
	---	HANDSH.			Type of handshake	2.2.5
		----		SOFTW.	Software handshake (X-On/X-Off)	2.2.5.1
		----		HARDW.	Hardware handshake (RTS/CTS)	2.2.5.2
		----	o	NONE	No handshake	2.2.5.3
	---	DATA BT.			Number of data bits	2.2.6
		----	o	7 BITS	7 data bits	2.2.6.1
		----		8 BITS	8 data bits	2.2.6.2
COMMUN.					Communication parameters	3.
	----	SBI			SBI communication parameter	3.1
	---	MAN.AUT.			Output	3.1.1
		----		MAN.W/O	Print individual value without stability	3.1.1.1
		----		MAN.W/	Print individual value after stability	3.1.1.2
		----	o	AUT.W/O	Print automatically without stability	3.1.1.4
		----		AUT.W/	Print automatically after stability	3.1.1.5
	---	CANCEL			Cancel automatic output	3.1.2
		----	o	OFF	Cancellation not possible	3.1.2.1
		----		ON	Cancel by pressing Print key	3.1.2.2
	---	FORMAT				3.1.3
		----	o	16 CHR.		3.1.3.1
		----		22 CHR.		3.1.3.2

Continued on next page

Level 1	Level 2	Level 3	Active	Level 4	Function	CODE
INPUT						4.
	-----	PASSWD.			Password	4.1.
		-----			Change/enter password	4.1.1
INFO					Information	5.
	-----	VER.NO.			Version number (firmware)	5.1
	-----	SER.NO.			Serial number	5.2
	-----	MODEL			Model designation	5.3
	-----	TYPE			Name/type information	5.4
	-----	INTRO			Intro text (if available)	5.5
LANG.					Language selection	6.
	-----	D			German	6.1
	-----	UK/US	o		English	6.2
	-----	F			French	6.4
	-----	I			Italian	6.5
	-----	E			Spanish	6.6
	-----	NL			Dutch	6.7
	-----	P/BR			Portuguese	6.8
	-----	PL			Polish	6.9
	-----	TR			Turkish	6.10
	-----	PYC			Russian/Cyrillic	6.11
	-----	SLO			Slovenian	6.12
	-----	SRB			Serbian	6.13
	-----	CODES			Number codes	6.25

4 Installation

IMPORTANT

The scale must be disconnected from the power supply for all assembly work.

4.1 Unpacking and Equipment Supplied

- ▶ Open the packaging, making sure to remove all parts carefully.
- ▶ After unpacking the device, check it immediately for any external damage.
- ▶ If you detect any damage, proceed as directed in Chapter "7 Care and Maintenance," page 29.
- ▶ Save the box and all parts of the packaging for any future transport. All cables should be unplugged when transporting.

The following parts are included in the equipment supplied:

Model name	PMA Evolution	PMA HD
Large weighing pan: Ø 233 mm	x	–
Small weighing pan: Ø 180 mm	–	x
USB connection cable	x	x
AC adapter with country-specific mains adapter	Optional	Optional
Installation instructions	x	x

4.2 Selecting a Setup Location

Select the right setup location:

- Set up the device on a stable, even surface that is not exposed to vibrations.
- Maintain free access to the device at all times.

Choose a location that is not subject to the following negative influences:

- Heat (heater or direct sunlight)
- Drafts from open windows, AC systems and doors
- Extreme vibrations during weighing
- Heavy "traffic areas" (personnel)
- Extremely high humidity
- Electromagnetic fields
- Extremely dry air

Acclimatization

Condensation from humidity can form on the surfaces of a cold device when it is brought into a warm area. You should therefore let a device acclimatize for approximately two hours disconnected from its power source before reconnecting it to the supply voltage.

M

Seal on Scales Verified for Use in Legal Metrology:

Legislation requires that a seal be affixed to verified scales. On Sartorius devices, this seal takes the form of a sticker with the "Sartorius" logo. If the seal is removed, the validity of verification will become void and you must have your scale re-verified. The verification supplied here is for verified weighing instruments for use in the EEA. Please keep it in a safe place.

4.3 Installing the Scale

Inserting the Weighing Pan

- ▶ Place the weighing pan onto the scale from above.

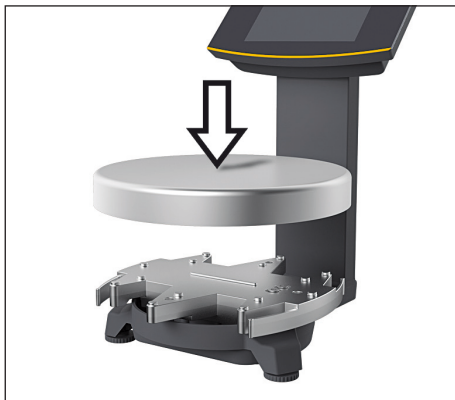

4.4 Supply Voltage

The scale is normally powered via the USB connection of your PC, which also supplies data for the scale. If this USB connection is not available, you can use AC adapter YEPS01-USB (see Chapter "12 Accessories," page 36) for the power supply, which comes with different, country-specific mains adapters. The assembly is described in the following.

4.4.1 Power Supply Assembly

If using a power supply, it will need to be assembled.



Using the wrong mains adapter may cause a fatal electric shock and damage the equipment.

Never plug the mains adapter into the socket when it is disconnected from the AC adapter (danger of electrical shock).

- ▶ Select the correct mains adapter for your mains power supply. The mains adapter must be suitable for use with the wall outlet at the installation site.

Mains adapter sets

Bag	Region/country
YEPS01-PS1	<ul style="list-style-type: none"> – USA and Japan (US+JP) – Europe (EU) – United Kingdom (GB)
YEPS01-PS6	<ul style="list-style-type: none"> – Argentina (AR) – Brazil (BR) – Australia (AU) – South Africa (ZA)
YEPS01-PS7	<ul style="list-style-type: none"> – China (CN) – India (IN) – Korea (KR)

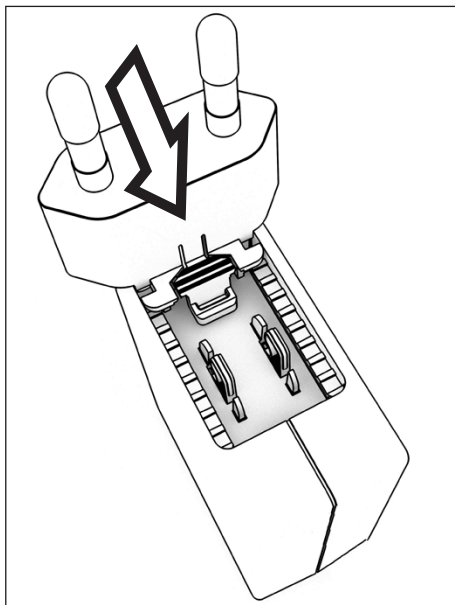

- ▶ Insert the power plug adapter into the power supply. The grooved button must be facing upwards.
- ▶ Push the power plug adapter as far as you can until it clicks into place.
- ▶ Check whether the power plug adapter is securely locked in place by pulling it gently.
- ▶ If the power plug adapter does not move, it is locked in place.

Removing/Replacing the Mains Adapter

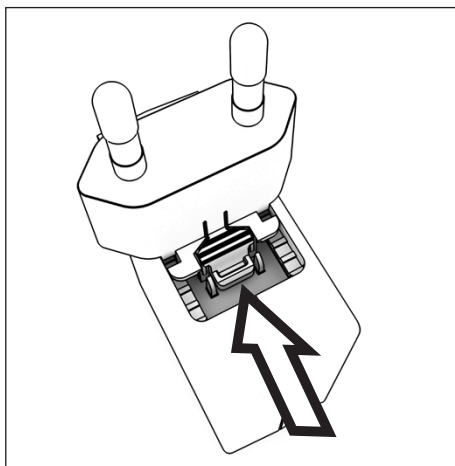

- ▶ Press the grooved button from above and pull back on the mains adapter.
- ▶ Push the power plug adapter out of the power supply and remove it.

Power Connection/Safety Precautions

- Only use original Sartorius AC adapters.
The AC adapter has an IP rating of IP40 in accordance with EN60529 / IEC60529.
- Make sure that the voltage rating printed on this unit matches the voltage at the place of installation.
- If the stated supply voltage or the plug design of the AC adapter does not comply with your country's standard then please inform your nearest Sartorius representative.
- The power must be connected in accordance with the regulations applicable in your country.

4.4.2 Connecting the Scale

Connecting the Scale

- ▶ Insert the USB cable into the USB socket on the back of the display.



Laying the USB Cable

- ▶ Lay the USB cable through the cable holders on the back of the scale.



Connection to the Power Supply

- ▶ Insert the USB cable into a USB socket of a PC or laptop.

Connecting an AC Adapter (Option)

- ▶ Insert the USB cable into the YEPS01-USB AC adapter.
- ▶ Plug the AC adapter into the wall outlet (supply voltage).

4.5 Anti-theft Locking Device

- ▶ If required, secure the scale at the back.



5 Commissioning

5.1 Leveling

Leveling for PMA HD and Verified Models



Leveling the scale compensates for slant or unevenness at the place of installation. The scale must be perfectly horizontal to ensure consistent, reproducible weighing results.

The scale needs to be re-leveled and then adjusted each time its setup location is changed.

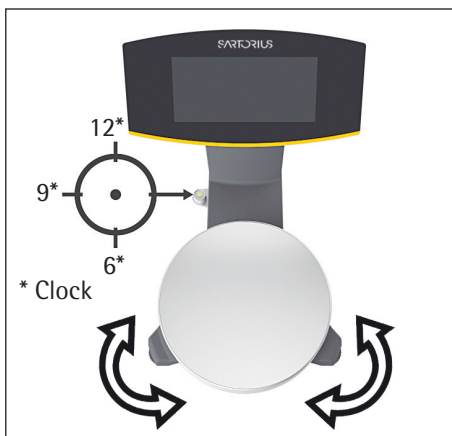

- ▶ Turn the two leveling feet as shown in the illustration until the air bubble is centered within the circle of the level indicator.
 - Air bubble at "12 o'clock:" Turn both feet clockwise.
 - Air bubble at "3 o'clock:" Turn the left foot clockwise and the right foot counterclockwise.
 - Air bubble at "6 o'clock:" Turn both feet counterclockwise.
 - Air bubble at "9 o'clock:" Turn the left foot counterclockwise and the right foot clockwise.

5.2 Warm-up Time

To ensure accurate results are delivered, the scale must warm up for at least 30 minutes after initial connection to the power supply. Only then will the device have reached the required operating temperature.

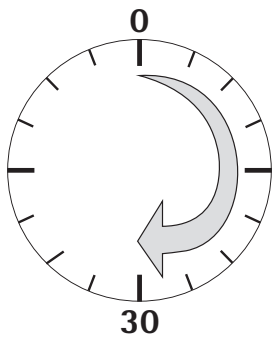



Using a Scale Verified for Use in Legal Metrology:

- Ensure that there is a warm-up time of at least 24 hours after initial connection to the power supply.

6 Operation

6.1 Switching the Device On/Off

Switching On



- ▶ Briefly press the  key (on/standby).
- ▷ An automatic self-test runs. This ends when the display shows 0.0 g.
- ▶ If another value is displayed: Set the scale to zero via the  key.

Switching Off

- ▶ Press and hold the  key for several seconds (on/standby).
- ▷ The scale switches to standby mode.

6.2 Locking the Keypad/Weight Display

Locking

- ▶ Briefly press the  key (on/standby) to lock the keypad and turn off the weight display.
- ▷ The padlock symbol  flashes for several seconds.
- ▶ Press the padlock symbol  while flashing to activate the lock.
- ▷ The keypad/weight display is locked and the padlock symbol lights up continually.

Unlocking

- ▶ Press the padlock symbol  to deactivate the lock.
- ▶ Enter the password (if set) (see Chapter 6.7.2.6, page 27).
- ▷ The lock is deactivated.

6.3 Zeroing/Taring

- ▶ Briefly press the  key.

6.4 Calibration/Adjustment



The scale needs to be re-leveled and then adjusted each time its setup location is changed.

Warm-up Time

To ensure accurate results are delivered, the scale must warm up for at least 30 minutes after initial connection to the power supply. Only then will the device have reached the required operating temperature.

- ▶ Wait approx. 30 minutes after connecting the scale to the power supply before adjusting the scale and weighing.

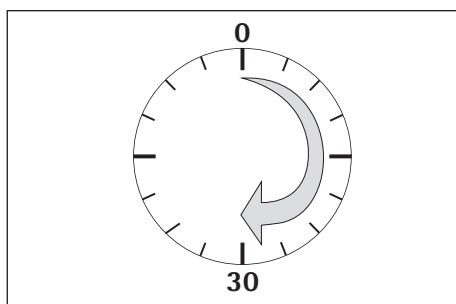

Using a Scale Verified for Use in Legal Metrology:

- Ensure that there is a warm-up time of at least 24 hours after initial connection to the power supply.

6.4.1 Calibration

External Calibration/Adjustment for Verified Scales

Scale for use in legal metrology must be externally calibrated before being verified at the location of use.

- When the scale is used in legal metrology, external calibration is locked as follows:
 - The menu access switch is locked
 - The menu access switch cap is sealed
- ▶ Press the **·0|T·** key for approx. two seconds.
- ▷ The pre-set calibration weight appears in the display (e.g., 5000 g, accuracy: + 0.075 g)
- ▶ If required, select a different calibration weight via the **▲**/**▼** keys.
- ▶ Confirm the displayed calibration weight via the **OK** key.
- ▷ **CAL.EXT.** appears on the display and the negative calibration weight.
- ▶ Center the calibration weight on the weighing pan.
- ▷ The calibration is performed. The calibration is complete when **CAL.DON** appears in the display.
- ▶ Remove the calibration weight from the weighing pan.

6.5 Weighing

M

Using a Verified Balance in Legal Metrology:

The Type-Approval Certificate for verified scales is only valid for non-automatic weighing instruments. For automatic operation with or without additional integrated equipment, please follow the applicable national regulations for the installation location.

- The temperature range (°C) listed on the ID label should not be exceeded during operation.

Example:

Ⓜ +10...+30°C

6.5.1 Weighing with One Decimal Place

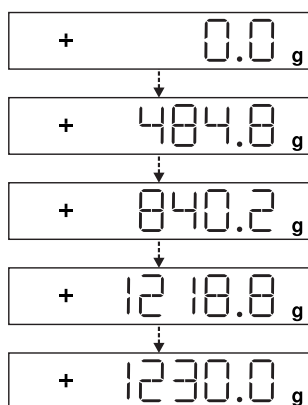

- ▶ Place the empty paint can on the weighing pan.
- ▶ Briefly press the **·0|T·** key to zero.
- ▷ The display shows "0.0 g."
- ▶ Add the first component "484.8 g."
- ▶ Read off the weight when the stability symbol (in this example) "g" is displayed.
- ▶ Add the other components until the desired weight (formula) is reached.
- ▶ Remove the filled paint can from the weighing pan.



Danger of Scale Damage!

Never close a paint can using a hammer while it is still on the weighing pan.

- ▶ When closing the paint can, place it on a firm, stable surface.

6.5.2 Weighing with Two Decimal Places (Not for Verified Models)



A menu setting is required for weighing with two decimal places (see Chapter "6.7.2.4 Activating the Toggle Key (Not for Verified Models)," page 26).



- ▶ Place the empty paint can on the weighing pan.
- ▶ Briefly press the **0|T** key to zero.



- ▷ The display shows "0.0 g."
- ▶ Press the toggle key **↔**.
- ▷ The display shows "0.00 g."



- ▶ Add the first component "205.50 g."
- ▶ Read off the weight when the stability symbol (in this example) "g" is displayed.

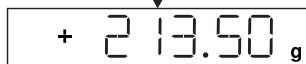

- ▶ Add the other components until the desired weight (formula) is reached.

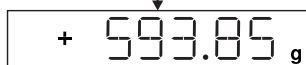

- ▶ Remove the filled paint can from the weighing pan.

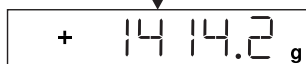

When the scale is tared and the second decimal place with a resolution of 0.05 g is activated via the toggle key **↔**, weighing up to 999.95 g with two decimal places can be performed.

Values over 999.95 g can only be weighed using one decimal place.



Danger of Scale Damage!

Never close a paint can using a hammer while it is still on the weighing pan.

- ▶ When closing the paint can, place it on a firm, stable surface.

6.6 Applications



Note for Scales for Use in Legal Metrology:

All application programs can be selected on scales verified for use in legal metrology. Calculated values can be marked using the following characters:

- Percent = %
- Computed values = 0, **◇** symbol

6.6.1 Calculation by a Factor

This function enables you to weigh in amounts that are smaller or larger than that of your basic formula for a specific paint color (e.g., 250 ml of a 1 l formula).

The factors (amounts) can be set via the factor key $\frac{\square}{\square}$ and \square/\square in a range of 0.1 to 6.0.

The following factors can be set directly via the factor key $\frac{\square}{\square}$:

0.25 0.5 0.75 1.0 1.5 2.0 2.5 3.0 3.5 4.0 4.5 5.0.

Using the keys \square (up) and \square (down), the factor can be changed

- in the range 0.10 to 1.0 in increments of 0.01
- in the range 1.0 to 6.0 in increments of 0.1

Factor Calculation Example

As you add the components of your formula, the weight is displayed in "g."



For legal metrology models, the displayed value is marked with an \diamond symbol to indicate computed values.

Suppose you want to weigh 250 ml for a basic formula that has a total of 1 l, and you don't want to have to manually recalculate the individual components of the formula.

The basic formula for 1 liter:

	250 g	1st component
+	250 g	2nd component
+	500 g	3rd component
Total:	1000 g	

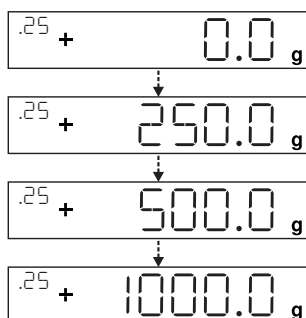

- ▶ Place the empty container on the weighing pan.
- ▶ Briefly press the $\cdot 0 | T \cdot$ key to tare.
- ▶ Press the factor key $\frac{\square}{\square}$ several times until the factor ".25" is displayed below the factor key.
- ▶ Slowly add the first component "250 g" until the display shows "250 g."
- ▶ Add the second color component "250 g" until the display shows "500 g."
- ▶ Add the third component "500 g" until the display shows "1000 g."

This concludes the calculation example. According to the display, exactly 1000 g was poured in, but the paint can actually contains 250 g by weight in accordance with the factor you selected.

The procedure is the same for any other conversion factor.

6.6.2 Weighing Using the Recalculation Function

Suppose that you poured in too much of one color component for a given formula (in this example, a four-component recipe).

This example further assumes that you previously poured in all of the other amounts exactly according to each of the values you entered and saved them by pressing the MEM key \square .

- ▶ Press the \square key to start the recalculation program.
- ▶ "C" flashes on the display.
- ▶ Correct the value using the \square/\square keys to match the specified formula value.
- ▶ Press the MEM key \square .

- ▷ The scale calculates the amount to be added for each of the components that were already poured. The display shows the amounts required to correct the formula up to the point at which the overpour occurred.
- ▶ After the correction has been completed, you can continue filling the remaining components.





You can correct overpours as often as needed. Keep in mind that the total quantity of paint (liter) at the conclusion of filling increases each time you correct a component. Press the  key to display the correction factor of the fill quantity. "C" = correction factor

Recalculation Example (Gross Weight)

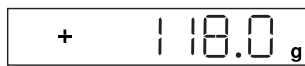

For legal metrology models, the displayed value is marked with an  symbol to indicate computed values.



- ▶ Place the empty container on the weighing pan.
- ▷ The scale shows the weight of the empty paint can.
- ▶ Briefly press the  key to tare.



- ▶ Slowly add the first component (50 g) of the formula until the display shows "50 g."
- ▶ Briefly press the  key to save the value.



- ▷ "STO 01" appears on the display, the first value is saved.



- ▷ "02" appears in the top left of the display (second color component).



- ▶ Add the second color component "110 g" until the display shows "110 g."
- ▶ Briefly press the  key to save the value.



- ▷ "STO 02" appears on the display, the second value is saved.



- ▷ "03" appears in the top left of the display (third color component).

- ▶ Add the third color component (200 g) until the display shows "200 g."

Oops! You poured in too much (203 g). The correct value for the formula is 200.0 g.

- ▶ Press the  key.

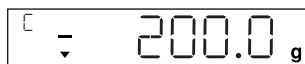

- ▷ The recalculation is started. "E" flashes in the top left of the display.

- ▶ Press the  key until the correct weight value "200 g" is displayed.

- ▶ Briefly press the  key to confirm the corrected value.



- ▷ "COR 01" flashes briefly on the display (correction of the first color component).

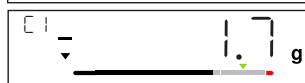

- ▷ "C1" appears in the top left and the weight value to be corrected "- 1.7 g."

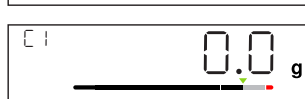

- ▶ Add 1.7 g of the first color component until the display shows "0.0 g" or the bar graph stops below the green arrow.
- ▶ Confirm the correction for the first color component by pressing the  key.



- ▷ "COR 02" flashes briefly on the display (correction of the second color component).

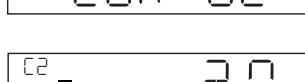

- ▷ "C2" appears in the top left and the weight value to be corrected "- 2.0 g."

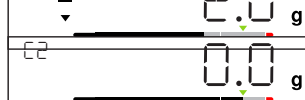

- ▶ Add 2.0 g of the second color component until the display shows "0.0 g" or the bar graph stops below the green arrow.

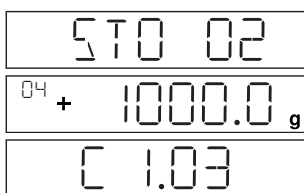

- ▷ "STO 02" appears on the display, the second (corrected) value is saved.
- ▷ You are automatically returned to the formulation program.
- ▷ "04" appears in the top left of the display (fourth color component).
- ▶ Press the \square key to check the amount of the total weight.
- ▷ The correction factor "C 1.03" appears on the display for several seconds. Total weight = weight of specified formula x correction factor.



- ▷ "04" appears again in the top left of the display after the correction factor is displayed (fourth color component).
- ▶ Add additional color components of the formula as described above.

This concludes the calculation example.

6.7 Menu Settings

6.7.1 Accessing the SETUP Menu

Accessing the SETUP menu and settings is described in the following using "Adapting the scale to ambient conditions" as an example (SETUP -> SCALE -> AMBIEN.):

- ▶ Press the \square key for approx. two seconds.
- ▷ Level 1 of the SETUP menu is displayed.
- ▶ Select the SETUP menu item of the first level using the \square / \square keys.
- ▶ Press the \square key.
- ▷ Level 2 of the SETUP menu is displayed.
- ▶ Select the SCALE menu item of the second level using the \square / \square keys.
- ▶ Press the \square key.
- ▷ Level 3 of the SETUP menu is displayed.
- ▶ Select the AMBIEN. menu item of the third level using the \square / \square keys.
- ▶ Press the \square key.
- ▷ Level 4 of the SETUP menu is displayed.
- ▶ Select the desired setting using the \square / \square keys.
- ▶ Press the \square key.
- ▷ The setting is applied; "o" appears on the display. (This concludes the example.)
- ▶ Press the \square key several times to exit the menu.



A detailed list of possible settings can be found in Chapter "3.4 Menu List," page 11.

6.7.2 Configuring the Main Menu Settings

6.7.2.1 Accessing the Setup Menu

- ▶ Press and hold the \square key for approx. 2 sec.
- ▷ SETUP (level 1) appears on the display.

6.7.2.2 Language Setting

Level 1 Level 2

LANG.		▶ Press \uparrow , select LANG.
		▶ Press OK
D	o German	▶ Press \uparrow/\downarrow , select language
UK/US	English	▶ Press OK , "o" appears
F	French	▷ The desired setting is applied
I	Italian	▶ Press C several times to exit the menu
etc.		

6.7.2.3 Standard Default Settings (0.1 g)/Polyrange (0.05 g/0.1 g) and Grams/Parts per Pound (Not for Verified Models)

The default settings which are active when the scale is switched on can be found under "SETUP > SCALE > WT.UNIT" and "SETUP > SCALE > DSP.DEC.:"

▶ Access the Setup menu (see Chapter 6.7.2.1, page 25).

Level 1 Level 2 Level 3 Level 4

SETUP			▶ Press OK
--- SCALE			▶ Press OK
--- WT.UNIT	Units		▶ Press \uparrow/\downarrow , e.g., select DSP.DEC.
	--- o GRAMS		▶ Press OK
	--- PT.P.LB		▶ Press \uparrow/\downarrow , e.g., select ALL
--- DSP.DEC.	Accuracy		▶ Press OK , "o" appears
	--- o ALL		▷ The new code is set
	--- POLYR.		▶ Press C several times to exit the menu

6.7.2.4 Activating the Toggle Key (Not for Verified Models)

When the toggle key S is active, you can use it to toggle the unit between, e.g., grams, parts per pound or the decimal place. The unit and/or decimal place is toggled when the key is pressed:

▶ Access the Setup menu (see Chapter 6.7.2.1, page 25).

Level 1 Level 2 Level 3 Level 4

SETUP			▶ Press OK
--- APP.PRG.			▶ Press \uparrow/\downarrow , select APP.PRG.
--- TOGGLE			▶ Press OK
	--- o ON		▶ Press \uparrow/\downarrow , select ON
	--- OFF		▶ Press OK , "o" appears
			▷ Toggle key S is activated
			▶ Press C several times to exit the menu

Configuring the Toggle Key S Function

Pressing the toggle key S toggles the scale between the default settings (see Chapter 6.7.2.3, page 26) and settings defined in "SETUP > APP.PRG. > UNIT" and "SETUP > APP.PRG. > DSP.DEC."

▶ Access the Setup menu (see Chapter 6.7.2.1, page 25).

Level 1	Level 2	Level 3	Level 4
SETUP			▶ Press OK
	--- APP.PRG.		▶ Press ▲ / ▼ , select APP.PRG.
		--- UNIT 2	▶ Press OK , press ▲ / ▼ , select UNIT 2
		--- o GRAMS	▶ Press OK , press ▲ / ▼ , select setting (e.g., GRAMS)
		--- PT.P.LB	▶ Press OK , "o" appears indicating the desired setting is applied
		--- DEC 2	▶ Press C
		--- ALL	▶ Press ▲ / ▼ , select DEC 2
		--- o POLYR.	▶ Press OK , press ▲ / ▼ , select setting
			▶ Press OK , "o" appears indicating the desired setting is applied
			▶ Press C several times to exit the menu

6.7.2.5 Activating the "LOCK" Function

The "LOCK" function protects the scale from unauthorized use. When this function is active, the scale readout shows weight values only when there is active communication between the scale and a PC. If communication is interrupted, the readout goes blank and the display shows a padlock symbol. Activation of the LOCK function is configured under "EXTRAS."

- ▶ Access the Setup menu (see Chapter 6.7.2.1, page 25).

Level 1	Level 2	Level 3	Level 4
DEVICE			▶ Press ▲ / ▼ , select DEVICE, press OK
	--- EXTRAS		▶ Press ▲ / ▼ , select EXTRAS, press OK
		--- LOCK	▶ Press ▲ / ▼ , select LOCK, press OK
		--- o ON	▶ Press ▲ / ▼ , select ON
		--- OFF	▶ Press OK , "o" appears
			▶ The "LOCK" function  is activated
			▶ Press C several times to exit the menu

6.7.2.6 Password Prompt

In addition to the "LOCK" function, you can also configure password protection for additional security. With this feature, the "LOCK" function can only be deactivated "OFF" by entering the password you configure.

Entering the Password

When the password prompt appears, the numbers 1 2 3 4 5 6 appear on the display. You can switch to the numbers 7 8 9 0 and back again via the **▲**/**▼** keys.

- ▶ Enter the password by entering the individual numbers on the display.
- ▶ When you enter the correct password, the "LOCK" function will be disabled.

Changing the Password

The password is numeric and can have up to six digits. Entering six spaces deletes the password, which deactivates the password function. This restores the device to its original setting (scale is not password-protected).

► Access the Setup menu (see Chapter 6.7.2.1, page 25).

Level 1 Level 2 Level 3

INPUT	► Press <input type="button" value="▲"/> / <input type="button" value="▼"/> , select INPUT, press <input type="button" value="OK"/>
--- PASSWD.	► Press <input type="button" value="▲"/> / <input type="button" value="▼"/> , select PASSWD., press <input type="button" value="OK"/>
--- OLD PW	▷ When an old password is active, OLD PW appears briefly so that you can enter the old password.
---	▷ This appears "-----."
---	▷ The first line flashes.
---	► Make the following inputs:
---	- <input type="button" value="▲"/> / <input type="button" value="▼"/> keys: Selects numbers 0 to 9.
---	- <input type="button" value="C"/> : Go back to the previous number.
---	- <input type="button" value="OK"/> : Confirm entry or go to the next number.
---	► Repeat to enter the remaining numbers.
---	▷ If you make an incorrect entry, NOT OK appears. Press <input type="button" value="OK"/> and reenter the old password.

NEW PW	▷ When you make a correct entry, NEW PW appears briefly so that you can enter the new password.
	▷ This appears "-----."
	▷ The first line flashes.
	► Make the following inputs:
	- <input type="button" value="▲"/> / <input type="button" value="▼"/> keys: Selects numbers 0 to 9.
	- <input type="button" value="C"/> : Go back to the previous number.
	- You can enter spaces to delete the number/password.
	- <input type="button" value="OK"/> : Confirm entry or go to the next number.
	► Repeat to enter the remaining numbers.
	▷ The password has been changed.
	► Press <input type="button" value="C"/> several times to exit the menu.

6.7.2.7 Resetting the Scale: "RESET"

If required, you can restore the scale to its factory settings.

Note:

If you have activated the password function, this feature is password-protected.

► Access the Setup menu (see Chapter 6.7.2.1, page 25).

Level 1 Level 2 Level 3 Level 4

SETUP	► Press <input type="button" value="▲"/> / <input type="button" value="▼"/> , select SETUP, press <input type="button" value="OK"/>
--- GEN.SRV.	► Press <input type="button" value="▲"/> / <input type="button" value="▼"/> , select GEN.SRV., press <input type="button" value="OK"/>
--- MEN.RES.	► Press <input type="button" value="▲"/> / <input type="button" value="▼"/> , select MEN.RES., press <input type="button" value="OK"/>
--- DEFAULT.	► Press <input type="button" value="▲"/> / <input type="button" value="▼"/> , select DEFAULT.
--- o NO	► Press <input type="button" value="OK"/> , "o" appears
	▷ The factory settings are loaded
	► Press <input type="button" value="C"/> several times to exit the menu

7 Care and Maintenance

7.1 Cleaning



Electrical Hazard from Voltage or Current

Disconnect the AC adapter from the power supply. If necessary, disconnect the data cable if connected to the scale. Never open the scale or the AC adapter.

The parts contained in these cannot be cleaned, repaired or replaced by the operator.

- Make sure that no liquid or dust gets into the scale or the AC adapter.
- Only use soft brushes and cloths for cleaning.
- Never use cleaning agents that contain solvents or abrasive ingredients (e.g., scouring cream, steel wool), which can ultimately damage the equipment.



Do not clean the following parts with acetone or aggressive cleaning agents: mains socket, data interface, labels, and all other plastic parts.

Cleaning the Control Panel

- ▶ Turn off the device before cleaning the control panel since touching the screen could trigger unwanted inputs.

Cleaning the Device Housing

- ▶ Clean the device.
- ▶ Use a soft cloth to dry the device.

7.2 Maintenance



Electrical Hazard from Voltage or Current

Repair work on the (optional) AC adapter must only be carried out by trained service technicians. Contact Sartorius Service for professional repairs (see Chapter 13, page 36).

To ensure the continued accuracy of your balance, we recommend scheduling regular servicing at least once a year.

The Sartorius Service Center offers different service contracts with maintenance intervals that are tailored to your needs.

A calibration certificate should always be issued as part of every maintenance session.

Safety inspections of the AC adapter and its connections must be performed at appropriate intervals by a qualified electrician (e.g., every two years).

8 Malfunctions

Problem	Cause	Remedy
No segments appear on the weight display	<ul style="list-style-type: none"> – No AC power is available 	<ul style="list-style-type: none"> – Check power supply
The weight readout shows "LOW"	<ul style="list-style-type: none"> – No weighing pan on the scale 	<ul style="list-style-type: none"> – Position the weighing pan
The weight readout shows "HIGH"	<ul style="list-style-type: none"> – Weighing capacity exceeded 	<ul style="list-style-type: none"> – Unload the scale
The weight readout changes constantly	<ul style="list-style-type: none"> – Unstable ambient conditions – Excessive vibration or draft – Weighing pan is being affected at some point by outside influences 	<ul style="list-style-type: none"> – Set up scale in another area – Adjust the scale settings (see Chapter "3.4 Menu List," page 11)
Is the weight readout obviously incorrect?	<ul style="list-style-type: none"> – The sample is not stable – Scale not tared before weighing 	<ul style="list-style-type: none"> – Tare before weighing
No weight value is shown and the padlock symbol  is displayed	<ul style="list-style-type: none"> – PC connection to the scale has been interrupted activating the "LOCK" function – Manual "LOCK" function is active 	<ul style="list-style-type: none"> – Access the menu to make the necessary adjustment and switch off the "LOCK" function – Check the connection – Switch off the manual "LOCK" function

9 Storage

If the device is not set up immediately after delivery, or will not be used temporarily, the ambient conditions listed in Chapter "11 Technical Data," page 32 must be observed for storage.



Only store the device in dry buildings and do not leave the device outdoors.

In case of improper storage, no liability will be assumed for resulting damage.

10 Recycling

Packaging

The packaging consists of environmentally friendly materials that can be used as secondary raw materials. The packaging is to be taken to a local waste disposal site if no longer required.

Device



The equipment, including accessories and empty non-rechargeable and rechargeable batteries, should not be disposed of in your regular household waste; this equipment is manufactured from high-grade materials which can be recycled and reused. The European Council Directive 2002/96/EC (WEEE) requires that electrical and electronic equipment be separated from normal household waste in order to recycle it. The crossed-out waste bin symbol indicates that separate collection is required.

In Germany and several other countries, Sartorius itself assumes responsibility for the return and legally compliant disposal of its electronic and electrical products. These products may not be placed with household waste or be brought to collection centers run by local public disposal operations – not even by small commercial operators. Please contact the Sartorius Service Center.

In countries that are not members of the European Economic Area (EEA) or where no Sartorius subsidiaries or dealerships are located, please contact your local authorities or a commercial disposal operator.

Prior to disposal and/or scrapping of the equipment, any batteries should be removed and disposed of at local collection points.



Sartorius will not take back equipment contaminated with hazardous materials (ABC contamination) – either for repair or disposal.

Addresses for Disposal

Detailed information with service addresses for the disposal of your device can be found on our website (www.sartorius.com).

11 Technical Data

11.1 General Data

SCALE	Unit	Value
Supply voltage		only via USB interface or Sartorius AC adapter YEPS01-USB
Input voltage	V _{DC}	+4,75 to +5,25
Power consumption	W	2.0
Further data		IP40 in accordance with EN 60529 / IEC 60529

Ambient conditions

The specifications apply under the following ambient conditions:

Environment		For indoor use only
Ambient temperature*	°C	0 to +40
Operational capability	°C	Guaranteed between +15 and +35
Storage and shipping	°C	-10 to +60
Relative humidity**	%	15 to 80 for temperatures up to 30°C non-condensing, decreasing linearly to 50% relative humidity at 40°C

Interface connection

		USB, type B (virtual serial interface)
Format		7-bit ASCII, 1 start bit, 1 or 2 stop bits
Parity		Even, odd, no parity
Transmission rates		600 to 57,600 bps
Handshake		Software or hardware

Electromagnetic compatibility

		In accordance with EN 61326-1/IEC 61326-1 Electrical equipment for measurement, control and laboratory use – EMC requirements – Part 1: General Requirements
Interference resistance		Basic requirements
Transient emissions		Class B Suitable for use in residential areas and areas that are connected to a low voltage network that also supplies residential buildings.



Verified scales in accordance with EU requirements comply with the requirements of Council Directive 2014/31/EC with EN 45501:2015 and OIML R76:2006.

* For verified scales in accordance with EU requirements, refer to the information on the scale.

** For verified scales in accordance with EU requirements, the legal regulations apply.

Available application programs

		Recalculation, formula
--	--	------------------------

Power supply YEPS01-USB (optional)

USB power plug		Type FSP007-P01P (manufacturer's designation)
Primary		100 – 240 V _~ , ±10%, 50 – 60 Hz, ±5%, ≤ 0.2 A
Secondary		5.2 V _{DC} , ± 5%, 1.4 A (max.)
Further data		Protection class II IP40 in accordance with EN 60529/IEC 60529

11.2 Model-specific Data

Specification	Unit	Value	Value
Model name		PMA Evolution, EVO1S	PMA HD, SPO1S
Weighing range	g	7500/999.95	2200
Readability	g	0.1/0.05	0.01/0.1
Tare range (subtractive)	g	-7500	-2200
External adjustment weight / accuracy class	kg	1, 2, 5 / F2 or better	1, 2 / F1 or better
Size of weighing pan	∅ mm	233	180
Net weight	kg	2.4	2.3

11.3 Verified Models with EC Type Approval Certificate: Model-specific Specifications

Specification	Unit	Value
Model name		PMA Evolution, EVO1S..EU..
Accuracy class		Ⓔ
Type		PMA-EV
Weighing capacity max.	g	7500
Scale interval d	g	0.1
Verification scale interval e	g	1
Temperature range		+10°C – +30°C
Tare equalization range (subtractive)		≤ 100% from max. weighing capacity

Specification	Unit	Value
Model name		PMA HD, SPO1S..EU..
Accuracy class		Ⓕ
Type		PMA-HD
Weighing capacity max.	g	2200
Scale interval d	g	1
Verification scale interval e	g	1
Temperature range		+10°C – +40°C
Tare equalization range (subtractive)		≤ 100% from max. weighing capacity

11.4 Geräteabmessungen

11.4.1 Modell EVO1S

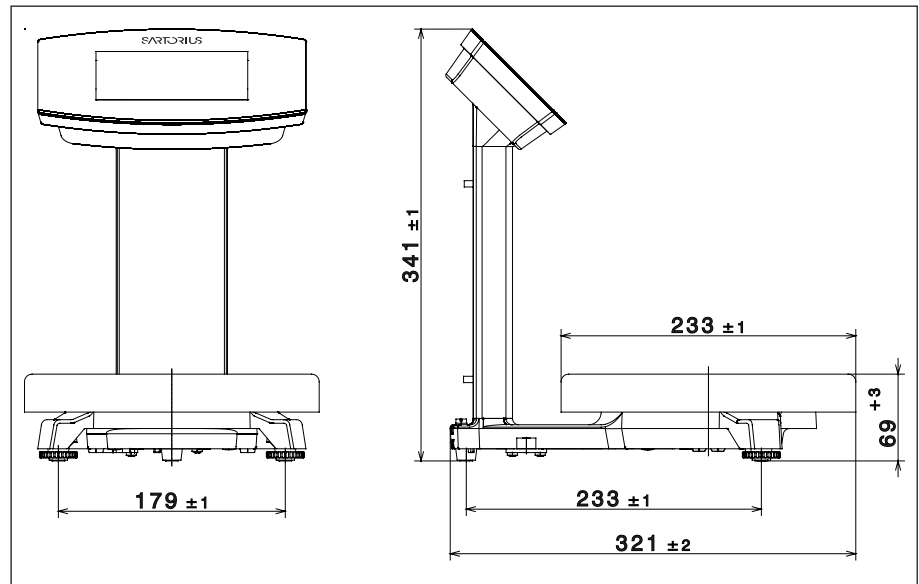

11.4.2 Modell SP01S

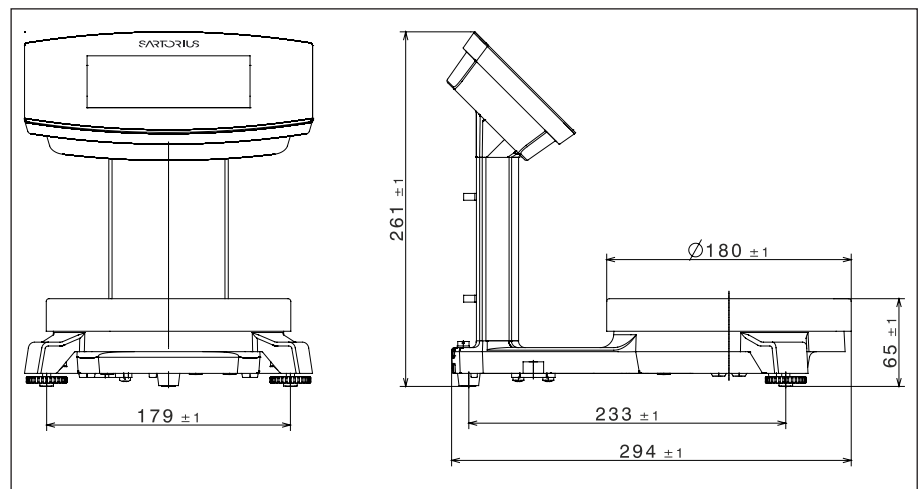

11.5 USB Interface (PC Port)

11.5.1 Purpose

This device can be connected to a PC via the USB interface.

A virtual serial interface (virtual COM port) is set up on the PC as a device type via the USB port. This virtual serial interface is identified and operated by the application program.

The xBPI and SBI protocols can be transmitted via the virtual serial interface.

11.5.2 Installing the Software Driver (Windows Update)

- ▶ Connect the scale to the USB port of the computer (see Chapter "4.4.2 Connecting the Scale," page 18).
- ▷ Windows will detect the scale connected to the USB port as a device. If the device is being connected for the first time, the Windows Installation Wizard will run automatically.
- ▶ Follow the instructions that appear.
- ▶ To complete the installation, click on Finish.
- ▷ The virtual interface is now ready for operation.

11.5.3 Installing the Software Driver

- ▶ Ensure that the scale is not connected to the PC.
- ▶ Download the "Virtual Com Port Driver" from the Sartorius Homepage: <https://www.sartorius.com/en/products/weighing/paint-mixing-solutions/paint-mixing-scales/pma-evolution>
- ▶ Launch the driver's Installation Wizard by double clicking on the "Setup.bat" file.
- ▶ Follow the instructions that appear.
- ▶ To complete the installation, click on "Finish".
- ▷ The virtual interface is now ready for operation.
- ▶ Connect the scale to the USB port of the computer (see Chapter "4.4.2 Connecting the Scale," page 18).



Windows® usually adds the virtual port in the position following your highest-numbered COM port.

Example:

For a PC with up to 4 COM ports, the new virtual port would then be COM5 (see Device Manager).

11.5.4 Installation Instructions for Windows XP® and Above

Changing the Port Number

If you use the USB interface with programs that limit the number of COM port designations (e.g., only COM1, 2, 3, 4), you may have to assign one of these port numbers to the new virtual port.

- ▶ Open the setting for the USB serial port in the Windows® Control Panel:
 - START > My Computer > Control Panel
 - System > Hardware > Device Manager
- ▶ Open the Connections submenu.
- ▶ Double-click on USB Serial Port.
- ▶ Select Port Settings > Advanced.
 - Use the "COM Port Number" button to change the port number.

Uninstalling the Driver

You can uninstall the software driver for the USB port via the Device Manager (only if the scale is connected):

- ▶ Use the right mouse button to click on the respective port.
- ▶ Then select "uninstall" from the context menu that appears.

12 Accessories

Accessories	Order Number
USB connection cable	YCC01-0040M5
Power supply (5.2 V/1.4 A)	YEPS01-USB
Mains adapter set for YEPS01-USB <ul style="list-style-type: none"> – USA and Japan (US+JP) – Europe (EU) – United Kingdom (GB) 	YEPS01-PS1
Mains adapter set for YEPS01-USB <ul style="list-style-type: none"> – Argentina (AR) – Brazil (BR) – Australia (AU) – South Africa (ZA) 	YEPS01-PS6
Mains adapter set for YEPS01-USB <ul style="list-style-type: none"> – China (CN) – India (IN) – Korea (KR) 	YEPS01-PS7
In-use cover for control panel, pack of 10	YDC03PMA10
In-use cover for support arm, PMA Evolution, pack of 10	YDC03PMA-CO10
In-use cover for weighing pan, PMA Evolution, pack of 10	YDC03PMA-WP10
Calibration weights	
for PMA Evolution:	
– 5 kg, accuracy class F2	YCW654-AC-00
– 2 kg, accuracy class F2	YCW624-AC-00
– 1 kg, accuracy class F2	YCW614-AC-00
for PMA HD:	
– 2 kg, accuracy class F1	YCW623-AC-00
– 1 kg, accuracy class F1	YCW613-AC-00

13 Sartorius Service

Sartorius Service is at your disposal for queries regarding the device. For information about the service addresses, services provided or to contact a local representative, please visit the Sartorius website (www.sartorius.com).

14 Conformity & Licenses

14.1 EU Declaration of Conformity

The attached Declaration of Conformity hereby confirms compliance of the device with the directives cited. The declaration of conformity supplied here is for verified balances for use in the EEA. Please keep it in a safe place.



Original
EG-/EU-Konformitätserklärung
EC / EU Declaration of Conformity

Hersteller **Sartorius Lab Instruments GmbH & Co. KG**
 Manufacturer 37070 Goettingen, Germany

erklärt in alleiniger Verantwortung, dass das Betriebsmittel
declares under sole responsibility that the equipment

Geräteart **Farbmischwaage**
 Device type *Paint-mixing scale*

Baureihe **PMA.Evolution**
 Type series

Modell **EVO1S1ab, EVO1S1ab-C, EVO1S1-WV4, SPO1S1a**
 Model a = N1, N2, N3 oder/or leer/blank ; b= BR, CI, EU, KR, RU oder/or leer/blank

in der von uns in Verkehr gebrachten Ausführung allen einschlägigen Bestimmungen der folgenden Europäischen Richtlinien entspricht und die anwendbaren Anforderungen folgender harmonisierter Europäischer Normen einschließlich deren zum Zeitpunkt der Erklärung geltenden Änderungen erfüllt:

in the form as delivered fulfils all the relevant provisions of the following European Directives and meets the applicable requirements of the harmonized European Standards including any amendments valid at the time this declaration was signed listed below:

	EMV / EMC	RoHS
Richtlinie <i>Directive</i>	2014/30/EU	2011/65/EU (incl. (EU) 2015/863)
Norm(en) <i>Standard(s)</i>	EN 61326-1:2013	EN 50581:2012

Die Person, die bevollmächtigt ist, die technischen Unterlagen zusammenzustellen:
The person authorized to compile the technical file:

Sartorius Lab Instruments GmbH & Co. KG
 Electronics & Product Compliance
 37070 Goettingen, Germany

Sartorius Lab Instruments GmbH & Co. KG
 Goettingen, 2021-02-21

 Dr. Reinhard Baumfalk
 Head of Product Development (LPS Division)

 Halil Yildirim
 Product Compliance Officer (SLI)



UK Declaration of Conformity

Manufacturer Sartorius Lab Instruments GmbH & Co. KG
37070 Goettingen, Germany
declares under sole responsibility that the equipment

Device type Paint mixing scale

Type series PMA.Evolution

Model EVO1S1, EVO1S1-C, EVO1S1Na-C, SPO1S1, SPO1Na
a = 1,2 or 3

in the form as delivered fulfils all the relevant provisions of the following British Regulations and meets the applicable requirements of the British Designated Standards including any amendments valid at the time this declaration was signed listed below. The fulfilment of the essential health and safety requirements have been demonstrated in respect of the product.

The Electromagnetic Compatibility Regulations 2016
UK Statutory Instruments 2016 No. 1091
BS EN 61326-1:2013

The Restriction of the Use of Certain Hazardous Substances in Electrical and Electronic Equipment Regulations 2012; UK Statutory Instruments 2012 No. 3032
BS EN 50581:2012

The person authorised to compile the technical file:

Sartorius UK Ltd.
Longmead Business Centre, Blenheim Road
KT19 9 QQ Epsom, Surrey, UK

Sartorius Lab Instruments GmbH & Co. KG
Goettingen, 2021-06-17

Dr. Reinhard Baumfalk
Head of Product Development (LPS)

Halil Yildirim
Product Compliance Officer (SLI)

Sartorius Lab Instruments GmbH & Co. KG
Otto-Brenner-Strasse 20
37079 Goettingen, Germany

Phone: +49 551 308 0
www.sartorius.com

The information and figures contained in these instructions correspond to the version date specified below.

Sartorius reserves the right to make changes to the technology, features, specifications and design of the equipment without notice.

Masculine or feminine forms are used to facilitate legibility in these instructions and always simultaneously denote all genders.

Copyright notice:

These instructions, including all components, are protected by copyright.

Any use beyond the limits of the copyright law is not permitted without our approval.

This applies in particular to reprinting, translation and editing irrespective of the type of media used.

Last updated:

03 | 2022

© 2022
Sartorius Lab Instruments GmbH & Co. KG
Otto-Brenner-Str. 20
37079 Goettingen, Germany

JW | Publication No.: WEV6006-e220308